



User Manual

for S6 Series Hybrid Inverter



Applicable models

S6-EH3P8K02-NV-YD-L

S6-EH3P10K02-NV-YD-L

S6-EH3P12K02-NV-YD-L

S6-EH3P15K02-NV-YD-L

Applicable System

Three phase system

Important Notes

- Due to the product development, the product specifications and functions are subject to change. The latest manual can be acquired via <https://www.ginlong.com/global>. Every attempt has been made to make this document complete, accurate and up-to-date. Individuals reviewing this document and installers or service personnel are cautioned, however, that Solis reserves the right to make changes without notice and shall not be responsible for any damages, including indirect, incidental or consequential damages caused by reliance on the material presented including, but not limited to, omissions, typographical errors, arithmetical errors or listing errors in the material provided in this document.
- Solis accepts no liability for customers' failure to comply with the instructions for correct installation and will not be held responsible for upstream or downstream systems Solis equipment has supplied.
- The customer is fully liable for any modifications made to the system; therefore, any hardware or software modification, manipulation, or alteration not expressly approved by the manufacturer shall result in the immediate cancellation of the warranty.
- Given the countless possible system configurations and installation environments, it is essential to verify adherence to the following:
 - There is sufficient space suitable for housing the equipment.
 - Airborne noise produced depending on the environment.
 - Potential flammability hazards.
 - Solis will not be held liable for defects or malfunctions arising from:
 - Improper use of the equipment.
 - Deterioration resulting from transportation or particular environmental conditions.
 - Performing maintenance incorrectly or not at all.
 - Tampering or unsafe repairs.
 - Use or installation by unqualified persons.
 - This product contains lethal voltages and should be installed by qualified electrical or service personnel having experience with lethal voltages.

Contents

1. Introduction	01-10
1.1 Product Overview	01
1.2 Inverter Wire Box and Connection Points	02
1.3 Product Features	03
1.4 System Description	04
1.5 Packaging	10
1.6 Tools Required for Installation	10
2. Safety & Warning	11-13
2.1 Safety	11
2.2 General Safety Instructions	11
2.3 Notice for Use	13
2.4 Notice for Disposal	13
3. Installation	14-35
3.1 Select a Location to Install the Inverter	14
3.2 Product Handling	16
3.3 Mounting the Inverter	17
3.4 Inverter Wiring Overview	19
3.5 Ground Cable Installation	20
3.6 PV Cable Installation	21
3.7 Battery Cable Installation	24
3.8 AC Wiring	25
3.9 CT Connection	26
3.10 Inverter Communication	27
3.11 Inverter Remote Monitoring Connection	35
4. Overview	36-37
4.1 Screen	36
4.2 Keypad	36
4.3 LED Indicators	36
4.4 Inverter built-in Bluetooth description	37
5. Commissioning	38-72
5.1 Pre-Commissioning	38
5.2 Power ON	38
5.3 Power OFF	38
5.4 HMI Screen Setting	39
5.5 Log in the APP via Bluetooth	49
5.6 Shutdown procedure	51
5.7 Work Mode and Settings	52
5.8 TOU Function Settings	57
5.9 Battery Settings	58

Contents

5.10 Battery Functions setting	59
5.11 Smart port settings	60
5.12 Grid port settings	63
5.13 Parallel Settings	64
5.14 Only PV power load function	64
5.15 Initial set up	66
5.16 APP Interface	72
6. Maintenance	84
6.1 Smart O&M	84
7. Troubleshooting	85
8. Specifications	90
9. Appendix - FAQs	90

1.1 Product Overview

The Solis series is designed for commercial hybrid systems.

The inverter can work with maximize self-consumption and provide backup power if the grid fails and there is not enough PV power to cover load demand.

The Solis S6 series consists of the following inverter models:

8kW, 10kW, 12kW, 15kW

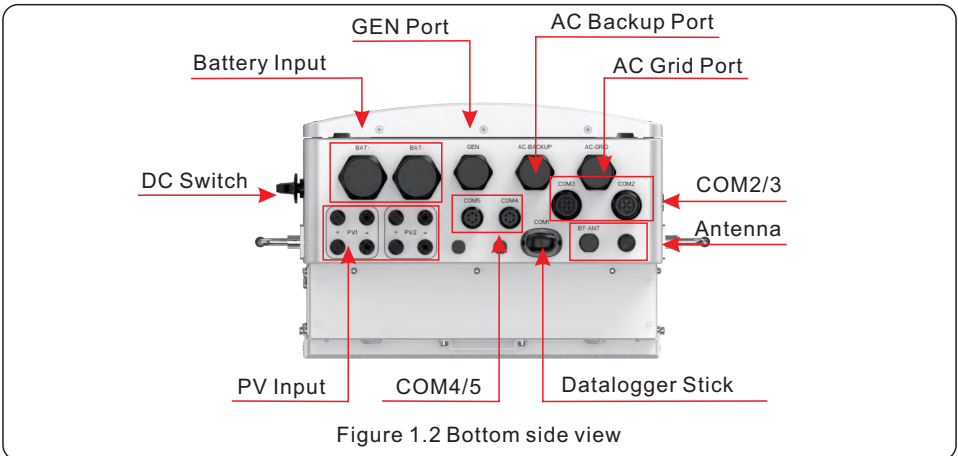
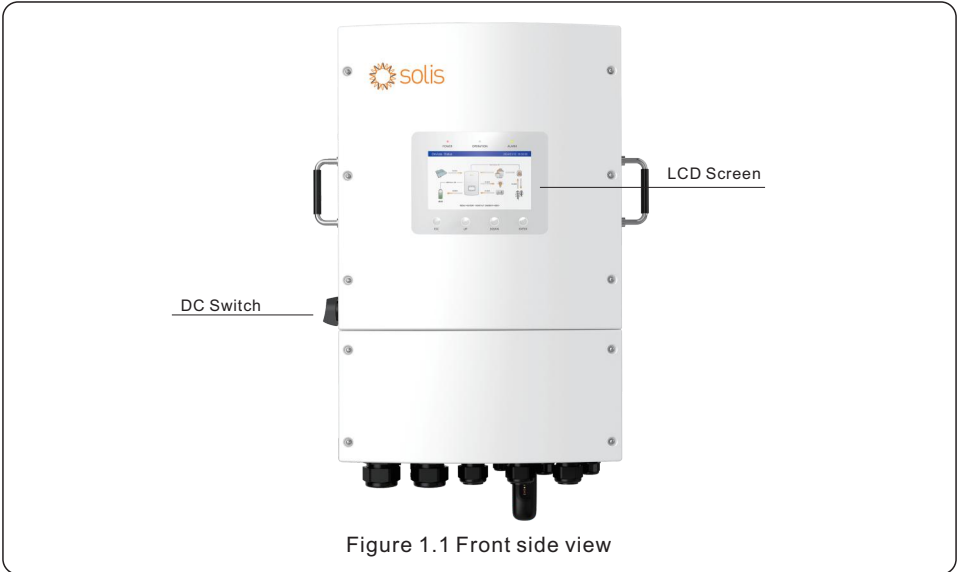

1.2 Inverter Wire Box and Connection Points

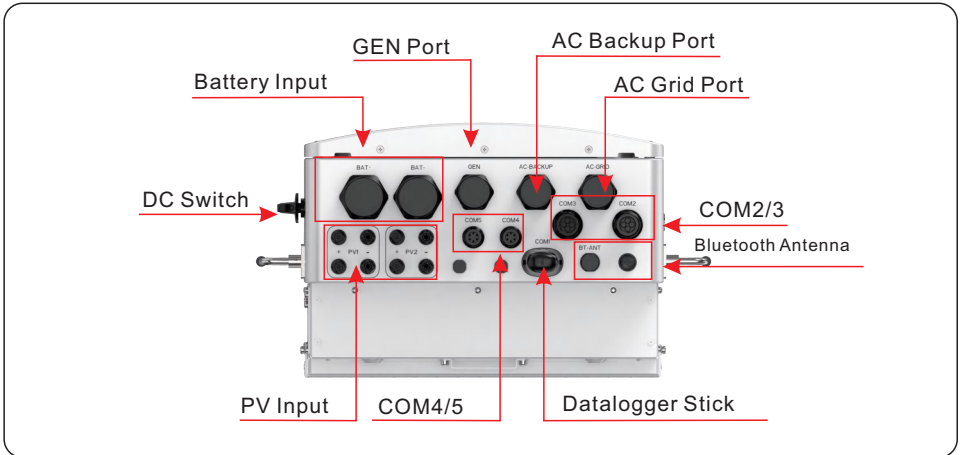

Name	Description
1. DC Switch	This is the DC disconnect switch for the PV
2. Battery Input	Conduit for Battery conductors should be connected here
3. GEN	Conduit for AC conductors to generator should be connected here
4. Backup	Conduit for AC conductors to backup loads panel should be connected here
5. Grid	Conduit for AC conductors to the main service panel should be connected here
6. PV Input	Conduit for PV conductors should be connected here
7. COM4/5	Conduit for CT conductors should be connected here
8. COM2/3	RS485 and CAN communication cables and parallel cables should go through these
9. Datalogger Stick	Solis data logger gets connected here-only USB version of the loggers will work
10. Bluetooth Antenna	Extends the range of the inverter Bluetooth signal(for system commissioning)

1.3 Product Features

Outstanding Performance

- Integrated 2 MPPTs with 3(8-12K)/4(15K) strings, suitable for residential rooftop installations with multiple array orientations.
- Compatible with multiple brands of battery models giving customers multiple battery options.
- Exquisite LED Indicators with built in Bluetooth to provide local operation without Internet.

Intelligent Function

- 20A input current adapted to high current PV Panel.
- 2 backup function achieves intelligent energy use plan.
- 6 customizable charge/discharge periods.
- Up to 180A/8K,220A/10K,250A/12K,290A/15K max charge/discharge current.
- Seamless switching when the utility grid loses power.
- Support start/stop control and status monitoring of genset.
- AC coupling to upgrade existing PV plant.
- Intelligent APP&7-inch colorful touch screen achieves visual and easy operation.
- Battery friendly with a large selection of brands.

Safe&Reliable

- Safety protection with integrated AFCI function, which actively detects arc faults in the PV Array.
- Multiple battery protection function.

1.4 System Description

1.4.1 Single system

The single system consists of PV module, battery, hybrid inverter, CT or smart meter. The PV Module converts solar energy into electric energy, which is then converted by the inverter to charge the battery or power loads or feed into the grid.

User can connect heat pump, existing PV plant, generator and ATS according to the actual scenario.

The system has three working modes: self-use mode, feed in priority mode and off-grid mode.

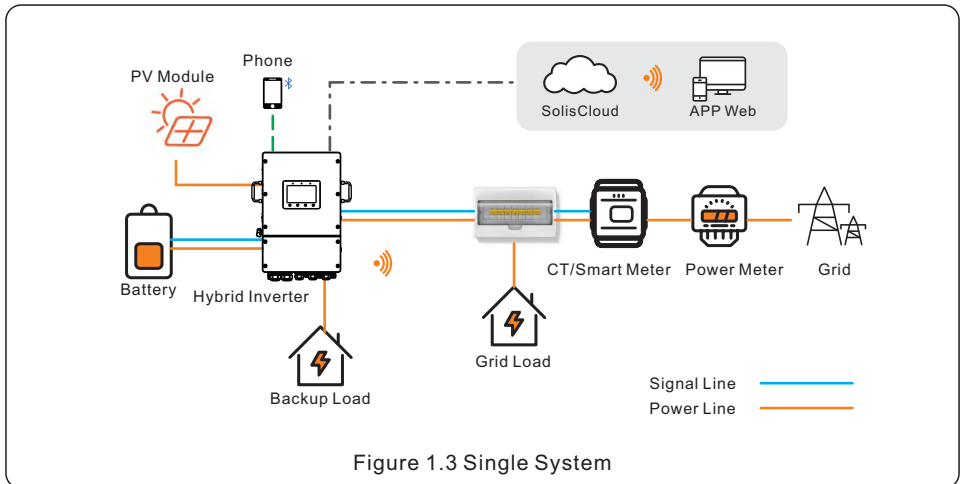

Figure 1.3 Single System



NOTE:

- If the CTs are connected, the Smart meter is not essential.
- you can choose CT scheme or Meter scheme deliver with inverter.
- In the event of a power outage on the grid, the system will seamlessly transition into off-grid mode, providing power exclusively to essential backup loads.
- When the grid recovers, the system switches back to the on-grid operation.
- Supports heat pump start-stop and power control, only when it has a SG Ready label.

1.4.2 Parallel System

User can add inverters and batteries to increase capacity. The system supports up to 6 inverters in parallel. Inverter Share a battery system.

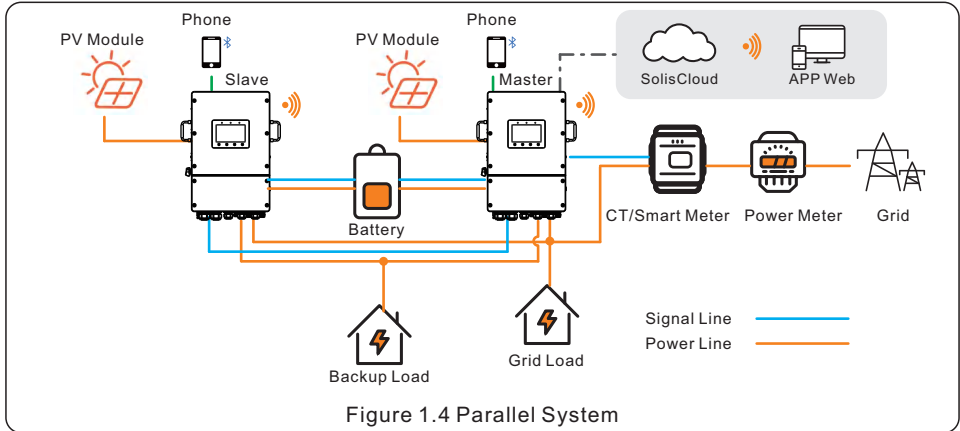

NOTE:

In parallel-system scenarios, maximum support 6 parallel connections. Parallel connection of different models is not supported. (Like 12K and 15K can't be connected in parallel).

The AC-Backup port can be connected in parallel, and the single-phase output power is 1 / 2 of the total AC power.

In parallel-system scenarios, connecting DG via ATS is recommended;

In the parallel system, each inverter is recommended to plug in the datalogger, otherwise, the remote upgrade cannot be performed.

The parallel cable between the two inverters should not exceed 5m.



NOTE:

Single inverter noise is less than 65 dB (A). When using multiple inverters to combine, pay attention to noise protection.

1.4.3 System with generator

The access of Diesel Generator is in the off-grid scenario.

The system stores PV energy in batteries during daytime, provided that there is energy surplus and supplies power to loads when the PV energy is insufficient or there is no PV energy at night.

When the battery power drops to a certain value, and a power outage occurs in the grid, the system will start the generator to power the load and charge the battery.

Generator's work logic is as follows:

- (i) when the grid is not available and the battery is discharged to GEN_Start_SOC, the generator starts to power the load and charges the battery to GEN_Exit_SOC, then the generator stops.
- (ii) If the load power > the generator rated power in (i), the battery will be discharged to power the load until Overdischarge_SOC, then generator may shutdown due to overload and the load will be powered off.
- (iii) If the generator fail to start in (i), the battery will be discharge to Overdischarge_SOC, then the load power off.
- (iv) If the system goes into the end of (iii), the battery will not discharge before it is charged to Overdischarge_SOC+ Overdischarge_Hysteresis_SOC (set by user).

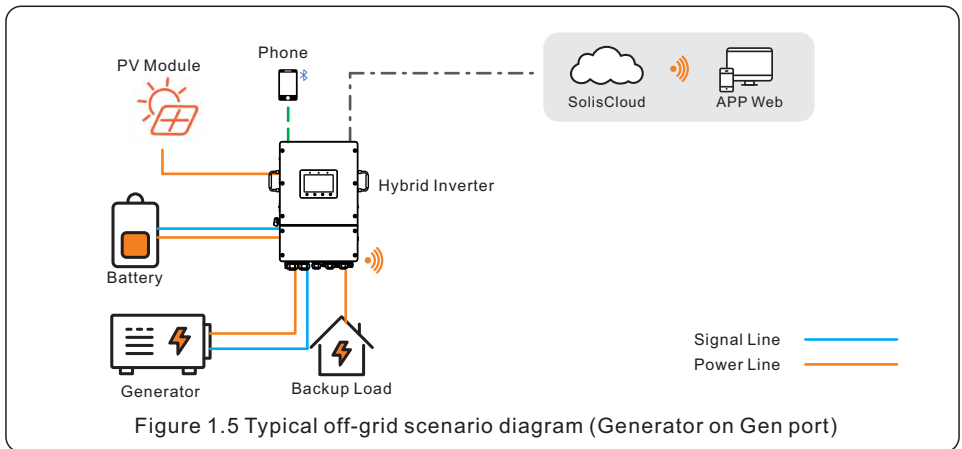

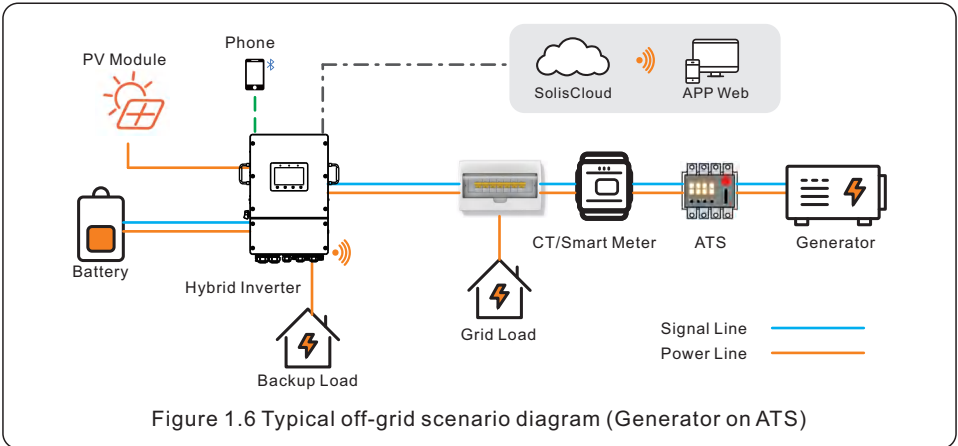

NOTE:



- In single system, a diesel generator can be connected via both AC-Gen port and ATS. If via AC-Gen port, it will only supply power to the backup load ; if it is necessary to supply power to the grid side, it is recommended that the generator be connected through ATS.
- In parallel-system scenarios, connecting a diesel generator via ATS is recommended.
- When the system is connected to the generator, it cannot be connected to a grid-tied inverter, because of a risk of damaging the generator.
- It is recommended that the generator power be greater than the backup load power.
- If the generator is connected through an ATS on the grid side, then CT or smart meter is required.

CAUTION:



When the generator is connected, it is essential to correctly select the generator position on the APP, otherwise it may cause system failure or damage to the generator.

1.4.4 System with grid-tied inverter

Generally, the access of grid-tied inverter is for the retrofit of a existing PV plant. The S6 hybrid inverter support access of both Solis grid-tied inverter and third-party grid-tied inverter.

1.4.4.1 Access of third-party grid-tied inverter

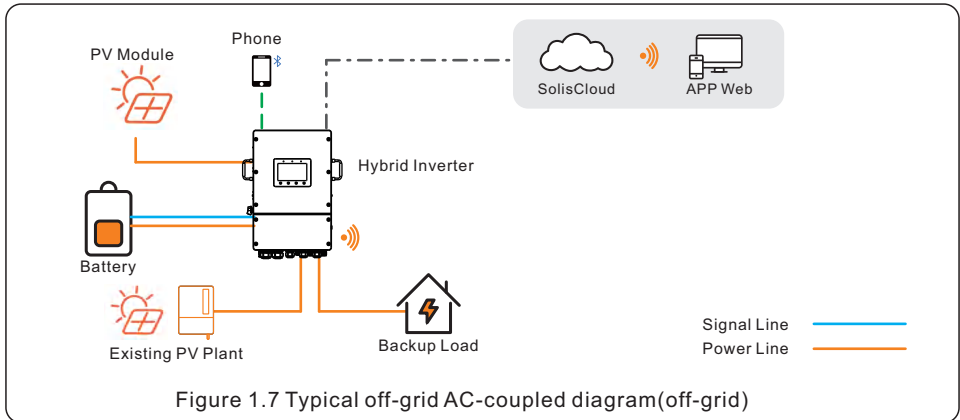

Figure 1.7 Typical off-grid AC-coupled diagram(off-grid)

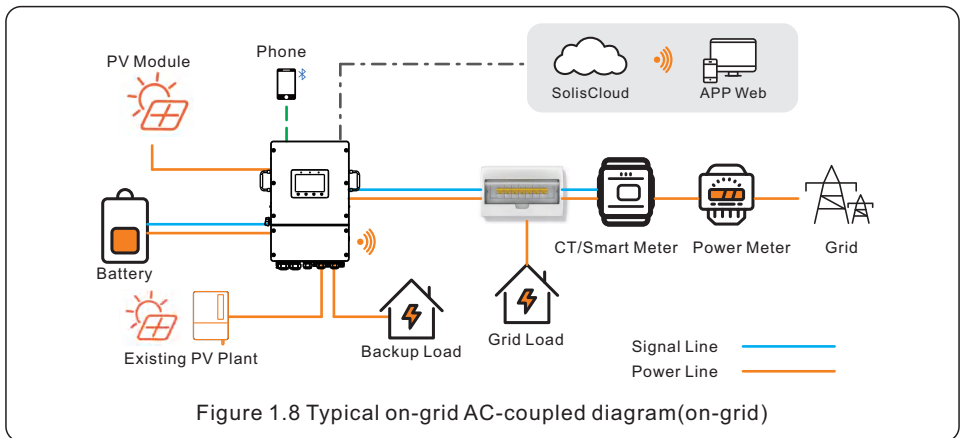

Figure 1.8 Typical on-grid AC-coupled diagram(on-grid)

- Third-party grid-tied inverter can be connected via AC-Gen port.
- With third-party grid-tied inverter connected to the system, it is recommended that:
Grid-tied inverter power < rated AC power of S6 inverter.
- In on-grid scenario, when the third-party grid-tied inverter is connected, the system cannot control the output power of the third-party grid-tied inverter, so Feed-in limitation cannot be realized.
- In off-grid scenario, the third-party grid-tied inverter must be configured with the correct grid code and equipped with over-frequency load shedding and under-frequency load rising functionalities. These features allow the system to dynamically adjust the frequency, effectively controlling the output power of the grid-tied inverter.

1.4.5 System with Smartload

The Gen port has extended power, which can be used as Smart load output.

You can use the smartload function to connect critical loads to the backup port and non-critical loads to the Gen port. This allows you to manage the power supply of different loads when off-grid.

When the battery SOC/Volt reach the ON set value, the smart port will supply power to the load. When the battery SOC/Volt drops to OFF SOC/Volt, it will cut off the power of the load.

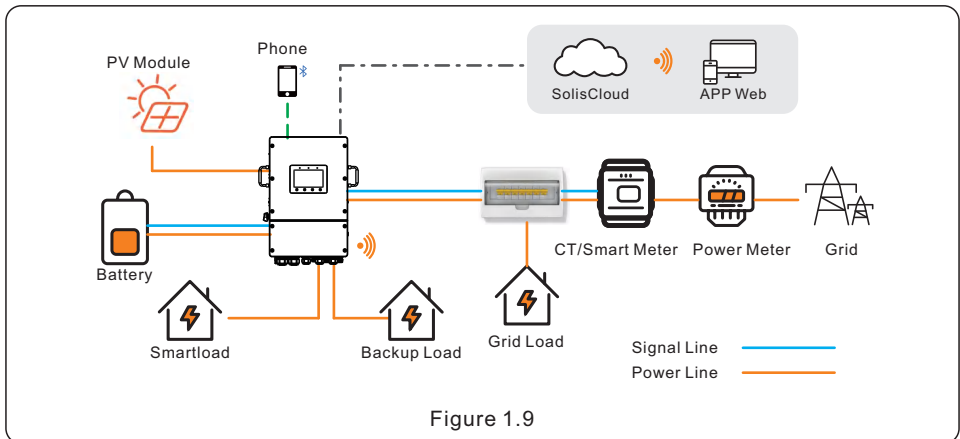

1.5 Packaging

Please ensure that the following items are included in the packaging with your machine:

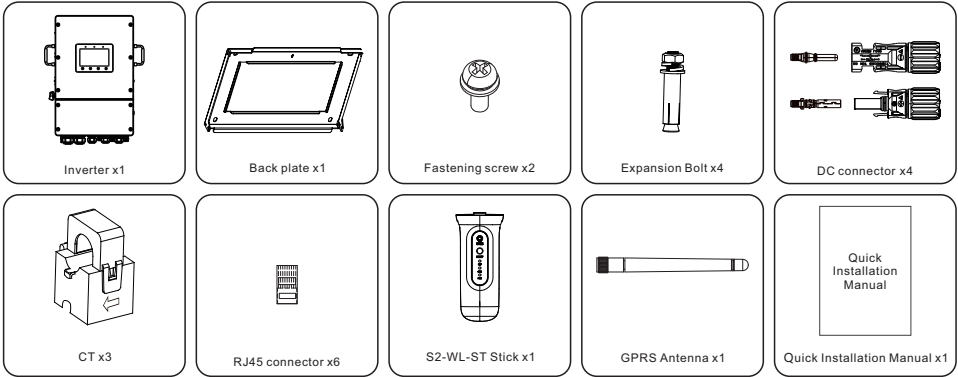

NOTE:

If customer purchases the CT configuration scheme, the attachment only contains CT.

If the meter configuration plan is purchased, the accessories include CT, the meter, and the meter communication cable.

CT Configuration: 100A/50mA CT; MODEL: ESCT-TA16

Meter Configuration: 40mA Meter+ 120A/40mA CT;

MODEL:SDM630MCT+ESCT-TA16

If anything is missing, please contact your local Solis distributor.

1.6 Tools Required for Installation



2.1 Safety

The following types of safety instructions and general information appear in this document as described below:



DANGER

“Danger” indicates a hazardous situation which if not avoided, will result in death or serious injury.



WARNING

“Warning” indicates a hazardous situation which if not avoided, could result in death or serious injury.



CAUTION

“Caution” indicates a hazardous situation which if not avoided, could result in minor or moderate injury.



NOTE

“Note” provides tips that are valuable for the optimal operation of your product.



WARNING: Risk of fire

Despite careful construction, electrical devices can cause fires.

- Do not install the inverter in an area containing flammable materials or gases.
- Do not install the inverter in a potentially explosive atmosphere.

2.2 General Safety Instructions



WARNING

Only devices in compliance with SELV (EN 69050) may be connected to the RS485 and USB interfaces.



WARNING

Do not connect PV array positive (+) or negative (-) to ground, doing so could cause serious damage to the inverter.



WARNING

Electrical installations must be done in accordance with local and national electrical safety standards.



WARNING

Do not touch any internal parts until 5 minutes after disconnection from the utility grid, PV array, and battery.



WARNING

To reduce the risk of fire, over-current protective devices (OCPD) are required for all circuits connected to the inverter.

The DC OCPD shall be installed per local requirements. All photovoltaic source and output circuit conductors shall have isolators that comply with the NEC Article 690, Part II.

All Solis single phase inverters feature an integrated DC disconnect switch.



CAUTION

Risk of electric shock, do not remove the cover. There are no serviceable parts inside, refer servicing to qualified and accredited service technicians.



CAUTION

The PV conductors are energized with high voltage DC when the PV modules are exposed to sunlight.



CAUTION

The surface temperature of the inverter can reach up to 75°C.

To avoid risk of burns, do not touch the surface of the inverter while it is operating. The inverter must be installed out of direct sunlight exposure.



NOTE

PV modules used with inverter must have an IEC 61730 Class A rating.



WARNING

Operations must be accomplished by a licensed electrician or a person authorized by Solis.



WARNING

Installer must wear personal protective equipment during the entire installation process in case of electrical hazards.



WARNING

The AC Backup Port of the inverter cannot be connected to the grid.



WARNING

Please refer to the product manual of the battery before installation and configuration to the inverter.



Systems using this product shall be designed and built in accordance with the NEC & local electrical codes & standards.

2.3 Notice for Use

The inverter has been constructed according to the applicable safety and technical guidelines, use the inverter in installations that meet the following specifications only:

1. Permanent installation is required.
2. The electrical installation must be compliant with all local and national regulations & standards.
3. The inverter must be installed according to the instructions stated in this manual.
4. The inverter must be installed according to the inverter technical specifications.
5. The inverter contains an internal NEB that meets the requirements of NRS 097-2-1:2024 Section 5.4.

2.4 Notice for Disposal

This product shall not be disposed as household waste.

It must be segregated and brought to an appropriate disposal facility to ensure proper recycling.

This is to be done in order to avoid negative impacts on the environment and human health.

Local waste management rules shall be observed and respected.

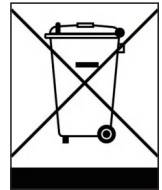

3.1 Select a Location to Install the Inverter

When selecting a location for the inverter, the following criteria should be considered:

- Exposure to direct sunlight may cause output power derating due to overheating. It is recommended to avoid installing the inverter in direct sunlight. The ideal location is one where the ambient temperature does not exceed 40°C.
- It is also recommended to install the inverter somewhere the rain and snow will not land directly on it. The ideal installation location is on a north-facing wall under an eave.

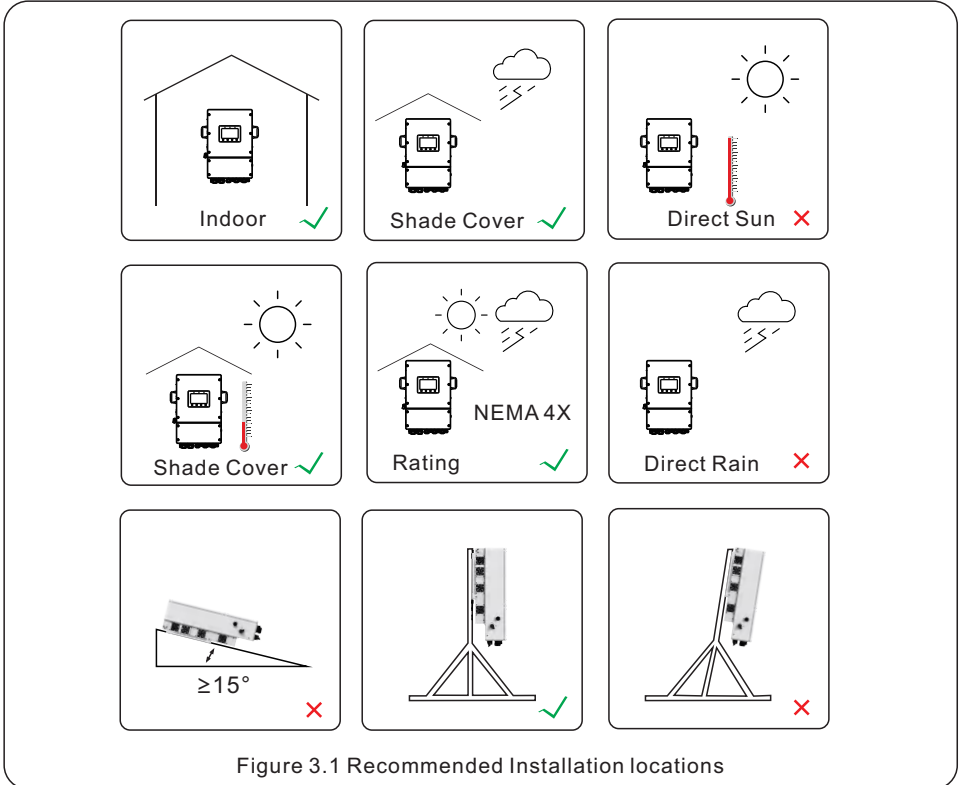

WARNING: Risk of fire



Despite careful construction, electrical devices can cause fires.

- Do not install the inverter in areas containing highly flammable materials or gases.
- Do not install the inverter in potentially explosive atmospheres.
- The mounting structure where the inverter is installed must be fireproof.

When selecting a location for the inverter, consider the following:



CAUTION: Hot Surface

- The temperature of the inverter heat-sink can reach 75°C.

The ambient temperature and relative humidity of the installation environment should meet the following requirements:

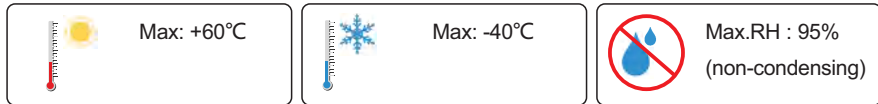

Figure 3.2 Installation environment conditions



Load bearing surface:

Made of non-inflammable materials

Max. load bearing capacity \geq 4 times of inverter weight

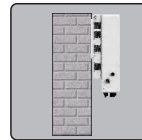

3.1.1 Clearances

The fan of the inverter is the left inlet wind, the right outlet wind .

To avoid overheating, always make sure the flow of air around the inverter is not blocked.

A minimum clearance of 300mm should be kept between objects;

A minimum clearance of 700mm should be kept between inverters;

In order to have enough space for installation and maintenance, we recommend that the front

distance is \geq 500mm, the bottom of the inverter should be

at least 500mm above of the ground or floor, which can be adjusted according to the actual situation.

3.1.2 Consult technical data

- Consult the technical specifications sections at the end of this manual for additional environmental condition requirements (temperature range, altitude, etc.)

3.1.3 Angle of installation

- This model of Solis inverter must be mounted vertically (90 degrees or backwards less than or equal to 15 degrees from 90 degrees straight up).

3.1.4 Avoiding direct sunlight

Installation of the inverter in a location exposed to direct sunlight should to be avoided.

Direct exposure to sunlight could cause:

- Power output limitation (with a resulting decreased energy production by the system).
- Premature wear of the electrical/electromechanical components.
- Premature wear of the mechanical components (gaskets) and user interface.

3.1.5 Air circulation

Do not install in small, closed rooms where air cannot freely circulate.
To prevent overheating, always ensure that the air flow around the inverter is not blocked.

3.1.6 Flammable substances

Do not install near flammable substances. Maintain a minimum distance of three meters (10 feet) from such substances.

3.1.7 Living area

Do not install in a living area where the prolonged presence of people or animals is expected. Depending on where the inverter is installed (for example: the type of surface around the inverter, the general properties of the room, etc.) and the quality of the electricity supply, the sound level from the inverter can be quite high.

3.2 Product Handling

Please review the instruction below for handling the inverter:

1. The red circles below denote cutouts on the product package - one per side.
Push in the cutouts to form handles for moving the inverter (see Figure 3.3).
2. Two people are required to remove the inverter from the shipping box. Use the handles integrated into the heat sink to remove the inverter from the carton.
3. When setting the inverter down, do it slowly and gently. This ensures that the internal components and the outer chassis do not take any damage.

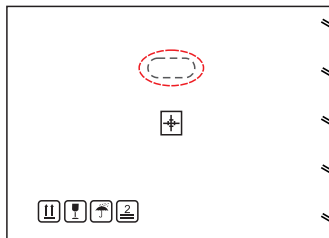

Figure 3.3

3.3 Mounting the Inverter

- Mount the inverter on a wall or structure capable of bearing the weight of the machine.
- The inverter must be mounted vertically with a maximum incline of +/- 5 degree. Exceeding this may cause the output power to derate.
- The fan of the inverter is the left inlet wind, the right outlet wind .To avoid overheating, always make sure the flow of air around the inverter is not blocked. A minimum clearance of 700mm should be kept between inverters and 300mm be kept from objects; In order to have enough space for installation and maintenance, we recommend that the front distance is $\geq 500\text{mm}$, which can be adjusted according to the actual situation.

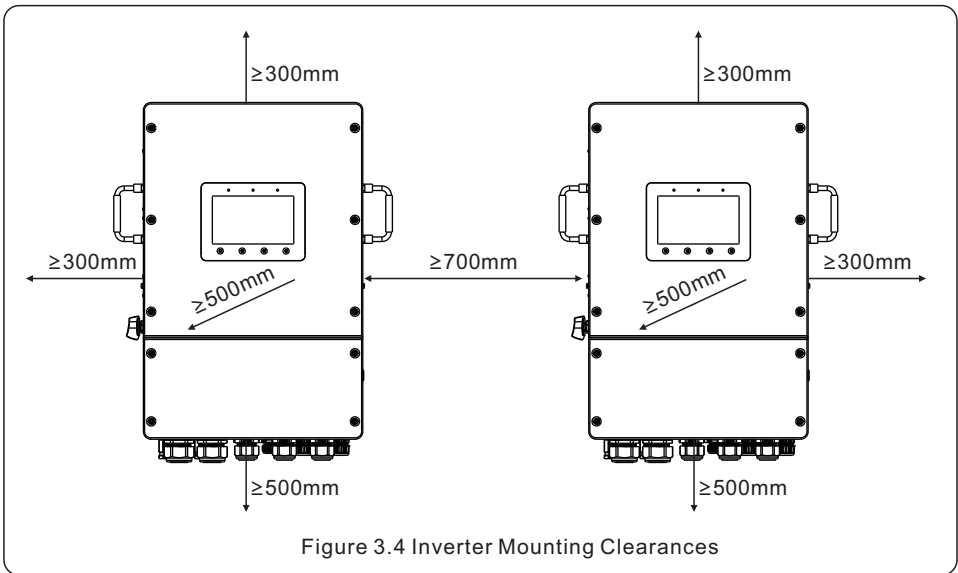

Figure 3.4 Inverter Mounting Clearances

- Visibility of the LED indicator lights should be considered.
- Adequate ventilation around the inverter must be provided.



NOTE

Nothing should be stored on the top of or placed against the inverter.

Dimensions of mounting bracket:

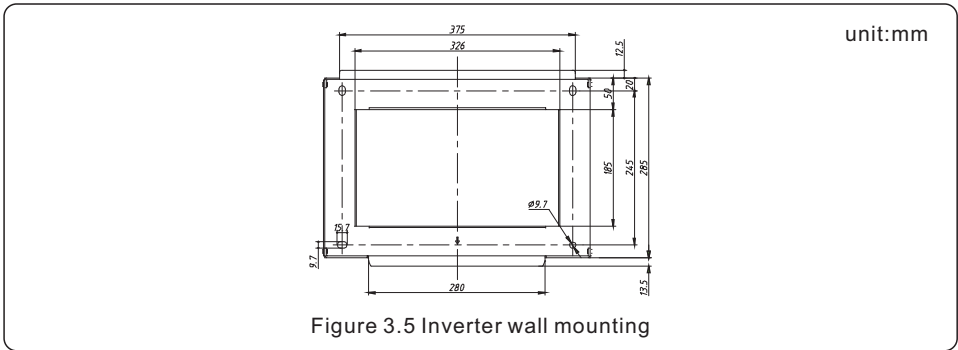

Once a suitable location has been found according to 3.1 using figure 3.5, mount the wall bracket to the wall.

The inverter shall be mounted vertically.

The steps to mount the inverter are listed as below:

1. Select the mounting height of the bracket and mark the mounting holes.
For brick walls, the position of the holes should be suitable for the expansion bolts.
2. Lift up the inverter (be careful to avoid body strain), and align the back bracket on the inverter with the convex section of the mounting bracket. Hang the inverter on the mounting bracket and make sure the inverter is secure (see Figure 3.6)

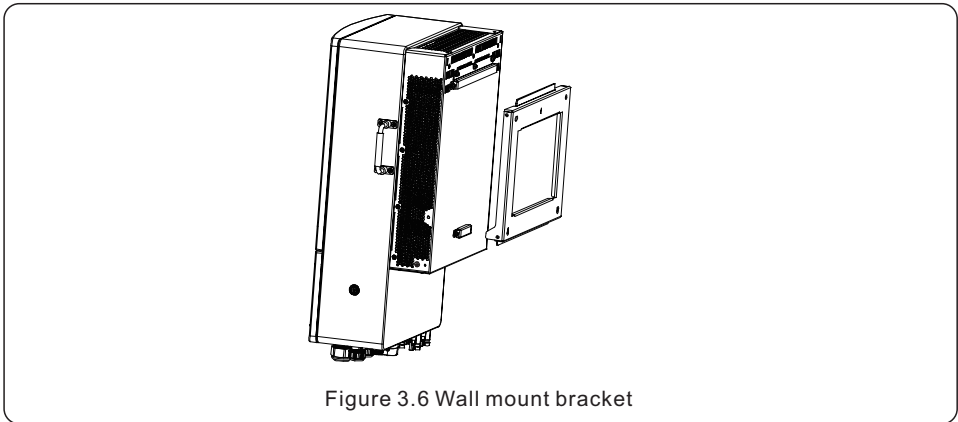

WARNING:

The inverter must be mounted vertically.

3.4 Inverter Wiring Overview

	Purpose	Connection Points
PV Cables	PV DC connection to the inverter	From the PV array to the DC+ and DC- terminals in the inverter
Battery Cables	Battery DC connection to the inverter	From the battery (+) and (-) terminals to the inverter BAT+ and BAT- terminals
AC Grid Cables	Inverter AC connection to the main service panel	From the OCPD in the main service panel to the AC-GRID L1, L2, L3 terminals
AC Backup Cables	Inverter AC connection to the backup subpanel	From the backup loads subpanel OCPD to the inverter AC-BACKUP L1, L2, L3 terminals
Ground Cables	Grounding conductors for the system	From the main service panel ground bar to the ground bar inside the inverter wire box
CT cable	Communication between inverter & CT	From meter to terminal HM. For more details, refer to figure Installing the energy meter
Battery communication cable	Communication between the inverter & the battery	From battery to terminal BMS. For more details, refer to figure Installing the battery
Data Logger (Optional)	Monitoring of the system on SolisCloud	USB COM port at the bottom of the inverter (For more details, please refer to the Solis data logger product manual)



NOTE

Conductor dimensions and OCPD sizing to be determined in accordance with the national electrical code (NEC) and local standards.

3.5 Ground Cable Installation

An external ground connection is provided at the both sides of inverter.

Prepare OT terminals: M5. Use proper tooling to crimp the lug to the terminal.

Connect the OT terminal with ground cable to the right side of inverter. The torque is 3.3N.m.

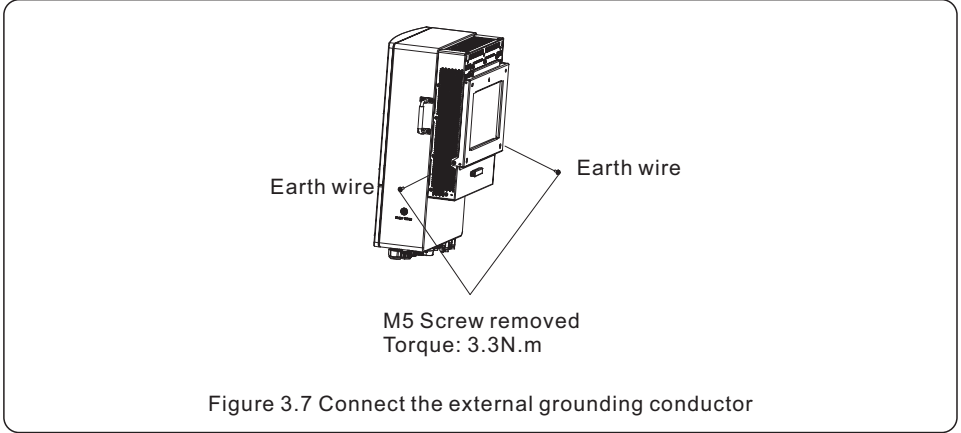

To connect the grounding terminal on the heat sink, please follow the steps below:

1. It is recommended to use copper wire for the chassis ground. Either solid conductor or stranded wire is acceptable. Refer to local code standard for wire sizing.
2. Attach OT terminal: M5.



IMPORTANT

For multiple inverters in parallel , all inverters should be connected to the same ground point to eliminate the possibility of a voltage potential existing between inverter grounds.

3. Strip the ground cable insulation to a suitable length.
4. Crimp a ring connector onto the cable and then connect it to the chassis ground terminal.

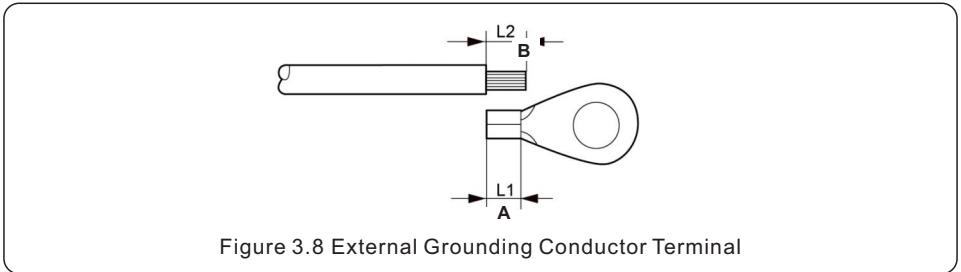

3.6 PV Cable Installation



Before connecting inverter, please make sure the PV array open circuit voltage is within the limit of the inverter.



Before connection, please make sure the polarity of the output voltage of PV array matches the "DC+" and "DC-" symbols.



Please use approved DC cable for PV system.

1. Select a suitable DC cable and strip the wires out by $7 \pm 0.5 \text{ mm}$. Please refer to the table below for specific specifications.

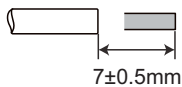

Cable type	Cross section (mm ²)	
	Range	Recommended value
Industry generic PV cable	4.0~6.0 (12~10AWG)	4.0 (12AWG)

Figure 3.9

2. Take the DC terminal out of the accessory bag, turn the screw cap to disassemble it, and take out the waterproof rubber ring.

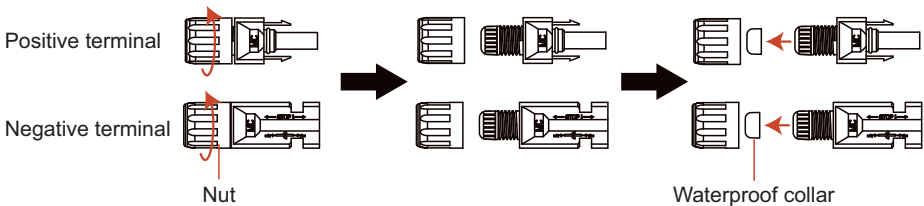
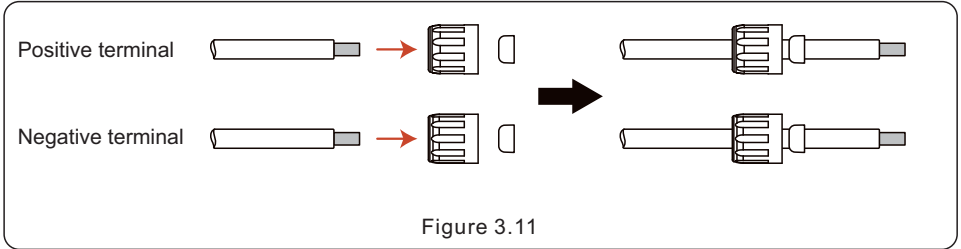
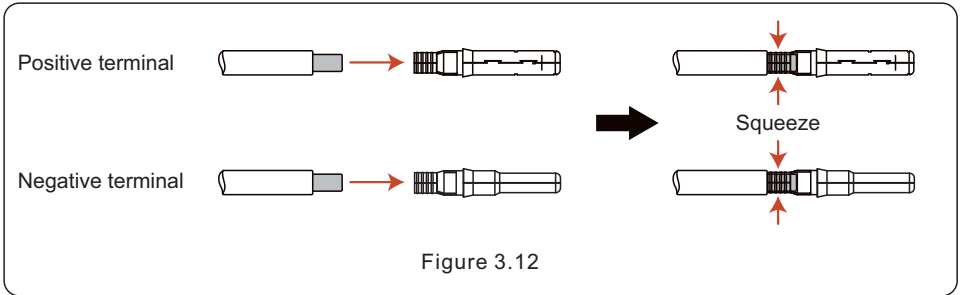

Figure 3.10

3. Pass the stripped DC cable through the nut and waterproof rubber ring.



4. Connect the wire part of the DC cable to the metal DC terminal and crimp it with a special DC terminal crimping tool.



5. Insert the crimped DC cable into the DC terminal firmly, then insert the waterproof rubber ring into the DC terminal and tighten the nut.

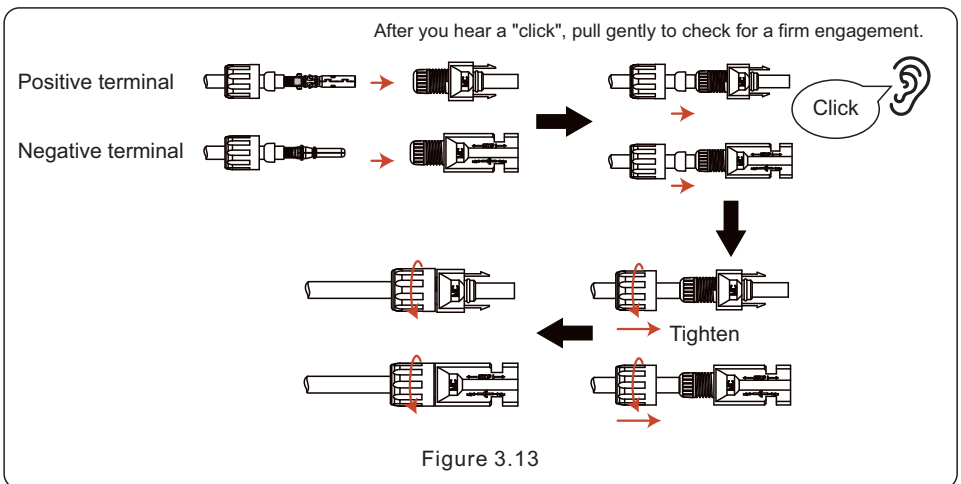

6. Measure PV voltage of DC input with multimeter, verify DC input cable polarity.

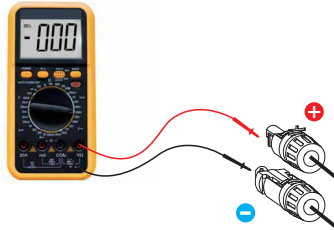

Figure 3.14

7. Connect the wired DC terminal to the inverter as shown in the figure, and a slight "click" is heard to prove the connection is correct.

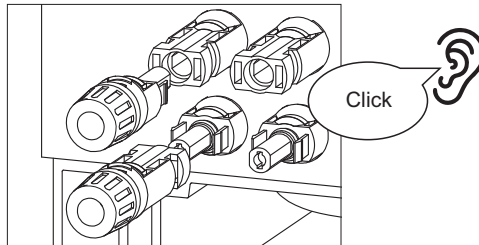

Figure 3.15



CAUTION:

If DC inputs are accidentally reversely connected or inverter is faulty or not working properly, it is NOT allowed to turn off the DC switch. Otherwise it may cause DC arc and damage the inverter or even lead to a fire disaster. The correct actions are:

*Use a clip-on ammeter to measure the DC string current.

*If it is above 0.5A, please wait for the solar irradiance reduces until the current decreases to below 0.5A.

*Only after the current is below 0.5A, you are allowed to turn off the DC switches and disconnect the PV strings.

* In order to completely eliminate the possibility of failure, please disconnect the PV strings after turning off the DC switch to avoid secondary failures due to continuous PV energy on the next day.

Please note that any damages due to wrong operations are not covered in the device warranty.

3.7 Battery Cable Installation



DANGER

Before installing the battery cables, be sure that the battery is turned off. Use a multimeter to verify that the battery voltage is 0Vdc before proceeding. Consult the battery product manual for instructions on how to turn it off.

1. The battery (+) and (-) cables shall only be connected to the inverter BAT terminals.
2. Run the cables into the wire box. Strip 13mm off the ends of each cable.
3. Crimp the R-type connectors onto the cables. Do not over crimp the connectors.
4. Remove the terminal bolts and then insert them through the connector holes.
5. Put each bolt back into the proper place, be sure to not reverse the polarity.
6. Tighten the bolts with a torque wrench screwdriver following the torque specs.

Terminal:
M8 screws*4

Recommended cable diameter:
2AWG*4(33.62mm²*4)

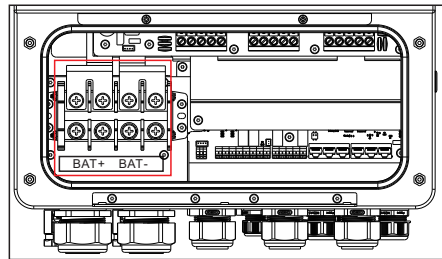

Figure 3.16 Battery cable connection

The BAT+ terminal provides 2 inputs, each with a maximum of 200A.
The BAT- terminal provides 2 inputs, each with a maximum of 200A.
Double connect the cable, up to 400A current
(max 290A charge/discharge current of the inverter).



NOTE

The battery fuse in the inverter wire box is replaceable.
The replacement can only be done by a technician authorized by Solis.



NOTE

Before connecting the battery, please carefully read the product manual of the battery and perform the installation exactly as the battery manufacturer specifies in the manual



NOTE

Please use the battery that has been matched by Solis.
Please see the battery matching list on the Solis official website.
If the battery is not in the list, our company will not carry out after-sales maintenance.

3.8 AC Wiring



DANGER

Before installing the AC cables, be sure that the OCPDs (breakers) are turned off.

Use a multimeter to verify that the AC voltages are 0Vac before proceeding.

There are three sets of AC output terminals and the installation steps for both are the same. The maximum temperature for connecting AC and battery terminals is 85°C.

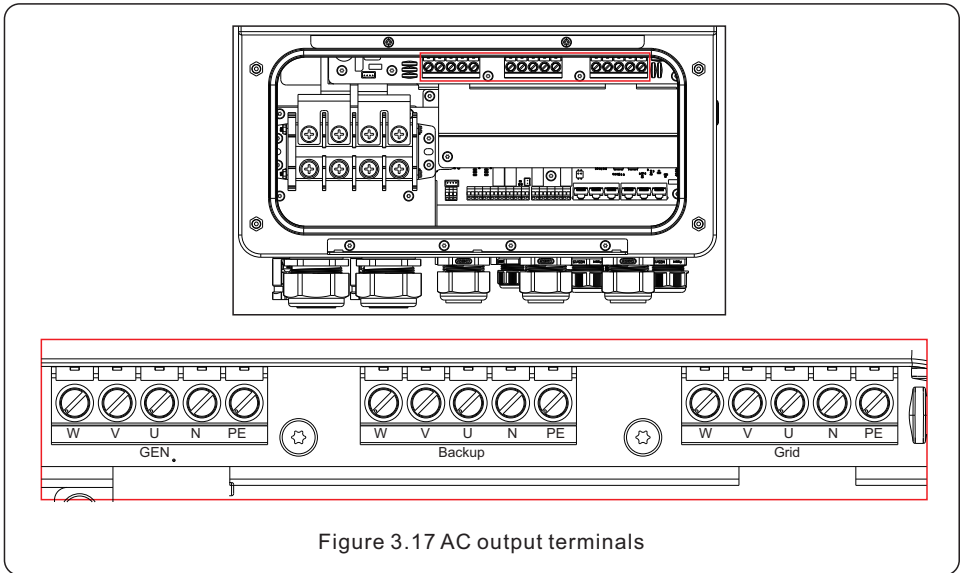

Figure 3.17 AC output terminals

Model	AC Gen/AC Backup/AC Grid	Earth Bar
Wire Size	6 AWG	10 AWG
Torque	18N.m	18N.m
Cable	10 mm2	4 mm2

1. Bring the AC cables for the backup loads panel (backup) and the main service panel (grid) into the inverter wire box. The backup loads panel should not be electrically connected to the main service panel.
2. Strip 13mm from the ends of each cable. Crimp the R-type connectors onto the ends.
3. Remove the terminal bolts, insert them into the connectors, then use a torque wrench to tighten the bolts down.
4. Please refer to the terminal labels to connect the AC wires to the correct terminals.

3.9 CT Connection



CAUTION:

Make sure the AC cable is totally isolated from AC power before connecting the or CT.

3.9.1 CT Installation

The CT provided in the product box is compulsory for hybrid system installation. It can be used to detect the grid current direction and provide the system operating condition to hybrid inverter.

CT Model: ESCT-TA16-100A/50mA

CT Cable: Size – 2.3mm², Length - 1m

Please install the CT on the hot line at the system grid connection point and the arrow on the CT needs to point to the grid direction.

Lead the CT wires through the COM3 port at the bottom of the inverter and connect the CT wires to the 16pin communication terminal block.

CT Wire	16 PIN Communication Terminal Block
White	Pin 1 (From Left to Right)
Black	Pin 2 (From Left to Right)
White	Pin 3 (From Left to Right)
Black	Pin 4 (From Left to Right)
White	Pin 5 (From Left to Right)
Black	Pin 6 (From Left to Right)

3.10 Inverter Communication

3.10.1 Communication Ports

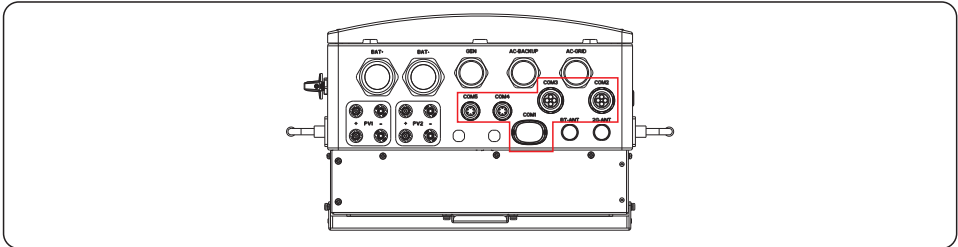

Port	Port Type	Description
COM1	USB	Used for Solis data logger connection
COM2	4 hole watertight cable gland	Used for RJ45 connection inside wiring box
COM3	4 hole watertight cable gland	Used for RJ45 connection inside wiring box
COM4	6 hole watertight cable gland	Used for 16 PIN terminal block connection inside wiring box
COM5	6 hole watertight cable gland	Used for 16 PIN terminal block connection inside wiring box

Wiring steps for COM2-COM5:

Step 1. Loose the cable gland and remove the watertight caps inside the cable gland based on the number of the cables and keep the unused holes with watertight cap.

Step 2. Lead the cable into the holes in the cable gland.

(COM2-COM3 Hole Diameter: 6mm, COM4-COM5 Hole Diameter: 2mm)

Step 3. Connect the cable to the corresponding terminals inside the wiring box.

Step 4. Reassemble the cable gland and ensure there is no bending or stretching of the cables inside the wiring box.



NOTE:

The 4-hole fastening rings inside the cable gland for COM2 and COM3 are with openings on the side.

Please separate the gap with hand and squeeze the cables into the holes from the side openings.

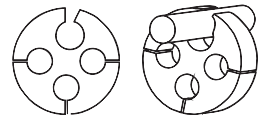

3.10.2 Communication Terminals

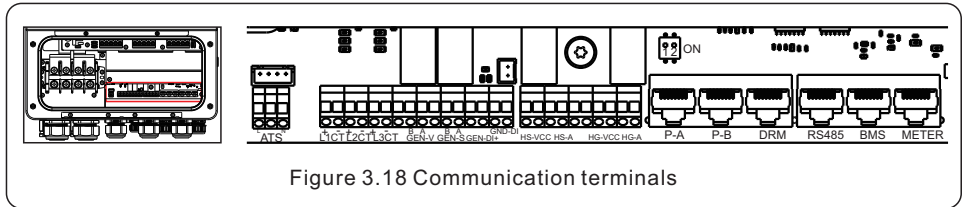

Figure 3.18 Communication terminals

Terminal	Type	Description
Meter	RJ45	(Optional)Used for RS485 communication between inverter and the smart meter.
BMS		Used for CAN communication between inverter and Lithium battery BMS.
RS485		Third-party external devices.
DRM		(Optional) To realize Demand Response or Logic Interface function, this function may be required in UK and Australia.
Parallel B/ Parallel A		(Optional) Parallel operation communication port.
HS-VCC/ HS-A/ HG-VCC/ HG-A	Terminal Block	Reserve(Heat pump).
GND-DI/ GEN-DI		Reserve(GEN signal).
GEN-S		Reserve.
GEN-V		Connect to GEN.
L1CT/ L2CT/ L3CT		Connect to Cts.
ATS		Reserve.
DIP Switch (2-1)	-	In parallel: Turn the DIP switch of the first and last inverter to: ON, and the other machines to OFF.

3.10.3 BMS Terminal Connection

3.10.3.1 With Lithium Battery

CAN communication is supported between inverter and compatible battery models.

Please lead the CAN cable through the COM1 or COM2 port of the inverter and connect to the BMS terminal with RJ45 connector.

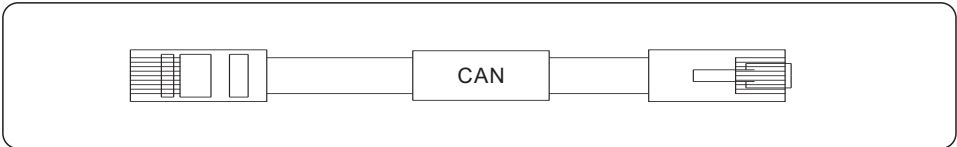

NOTE:



Before connecting CAN cable with the battery, please check whether the communication pin sequence of the inverter and the battery match; If it does not match, you need to cut off the RJ45 connector at one end of the CAN cable and adjust the pin sequence according to the pin definitions of both inverter and battery.

Pin definition of the inverter BMS Port is following EIA/TIA 568B.

CAN-H on Pin 4: Blue

CAN-L on Pin 5: Blue/White

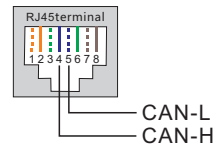

NOTE:



Before connecting RS485 cable with the battery, please check whether the communication pin sequence of the inverter and the battery match; If it does not match, you need to cut off the RJ45 connector at one end of the RS485 cable and adjust the pin sequence according to the pin definitions of both inverter and battery.

Pin definition of the inverter BMS Port is following EIA/TIA 568B.

RS485A on Pin 6: Green

RS485B on Pin 3: Green/White

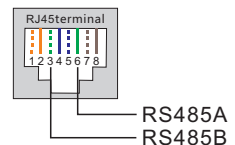

3.10.4 Meter Terminal Connection (Optional)

If a smart meter is preferred to be installed other than the provided CT, please contact Solis sales rep to order the smart meter and corresponding meter CT.

Please lead the Meter RS485 cable through the COM1 or COM2 port of the inverter and connect to the Meter terminal with RJ45 connector.

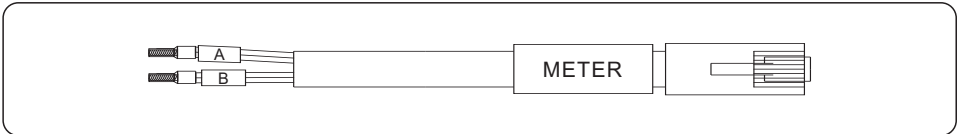

NOTE:

Pin definition of the Meter Terminal is following EIA/TIA 568B.

RS485A on Pin 1: Orange/white

RS485B on Pin 2: Orange

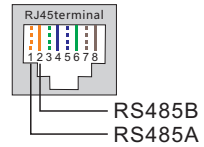

3.10.5 DRM Port Connection (Optional)

3.10.5.1 For Remote Shutdown Function

Solis inverters support remote shutdown function to remotely control the inverter to power on and off through logic signals.

The DRM port is provided with an RJ45 terminal and its Pin5 and Pin6 can be used for remote shutdown function.

Signal	Function
Short Pin5 and Pin6	Inverter Generates
Open Pin5 and Pin6	Inverter Shutdown in 5s

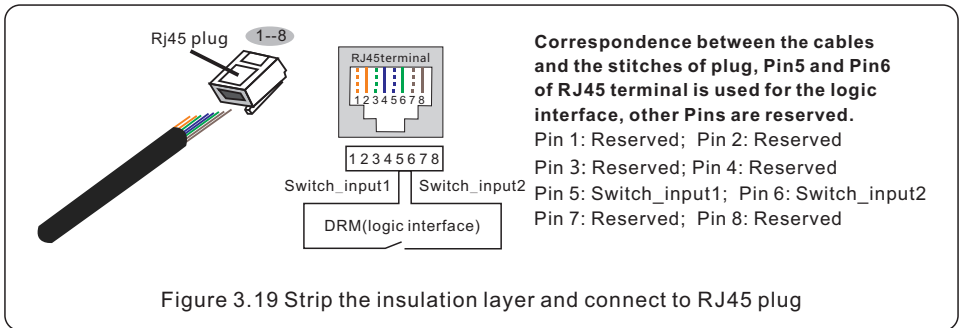

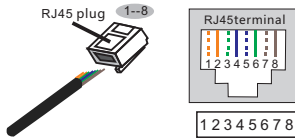

Correspondence between the cables and the stitches of plug
 Pin 1: white and orange ; Pin 2: orange
 Pin 3: white and green; Pin 4: blue
 Pin 5: white and blue; Pin 6: green
 Pin 7: white and brown; Pin 8: brown

Figure 3.20 Strip the insulation layer and connect to RJ45 plug

3.10.6 RS485 Port Connection (Optional)

If a 3rd party external device or controller needs to communicate with the inverter, the RS485 port can be used. Communication protocol is supported by Solis inverters.

To acquire latest protocol document, please contact Solis local service team or Solis sales.



NOTE:

Pin definition of the RS485 Port is following EIA/TIA 568B.

RS485A on Pin 5: Blue/White
 RS485B on Pin 4: Blue

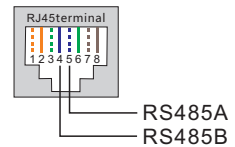

3.10.7 Parallel Inverter Connection (Optional)

Up to 6 units of the inverter can be connected in parallel.

Please connect the paralleled inverters by using P-A and P-B terminals.

Standard CAT5(≤5m, between two inverters) with shielding layers internet cable can be used.

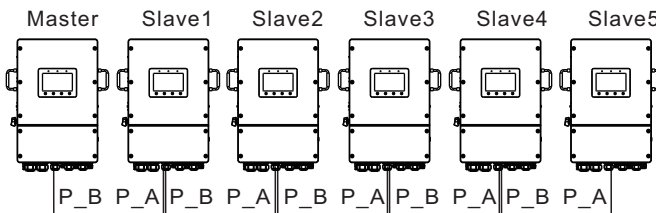
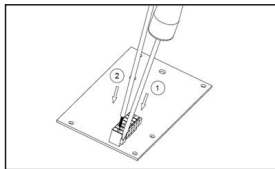

Figure 3.21 Parallel Terminal Connection

3.10.8 16-pin Communication Terminal Block

Terminal Block Connection Steps:

- Step 1. Lead the wires through the hole in COM3 port (Hole Diameter: 2 mm)
- Step 2. Strip the wires for 9mm length
- Step 3. Use slot type screwdriver to press the block on the top
- Step 4. Insert the exposed copper part of the cable into the terminal.
- Step 5. Remove the screwdriver and the terminal will clamp down on the exposed copper part.
- Step 6. Give the cable a gentle tug to ensure that it is firmly secured.



3.10.8.1 HM Terminal Connection (CT Terminal Connection)

CT connection is necessary to realize the correct control logic of the hybrid inverter.

The CT provided in the inverter package has BLACK(S2) and WHITE(S1) wires. The BLACK wire needs to connect to the Pin 2, Pin 4, Pin6 of the terminal block and the WHITE wire needs to connect to the Pin 1, Pin3, Pin5 of the terminal block as in the following diagram.

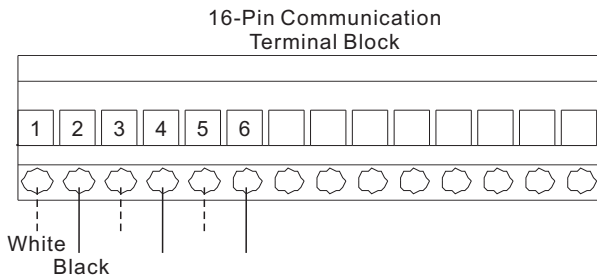

3.10.8.2 G-V Terminal Connection

The G-V terminal is a voltage-free dry contact signal for connecting with generator's NO relay to start up the generator when necessary.

When generator operation is not needed, Pin7 and Pin8 is in open circuit.

When generator operation is needed, Pin7 and Pin8 is in short circuit.

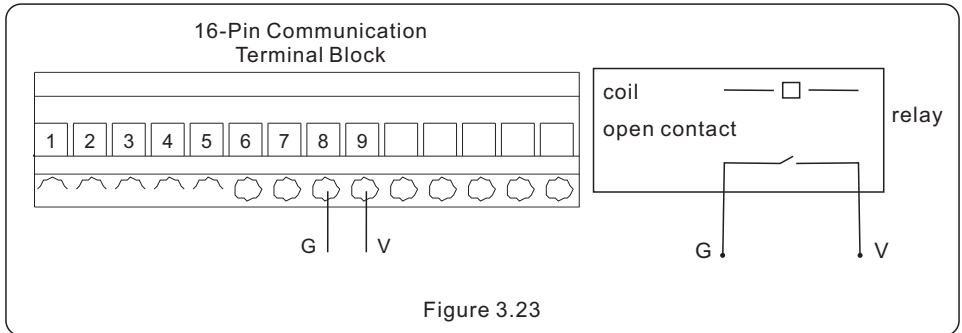

3.11 Inverter Remote Monitoring Connection

The inverter can be remotely monitored via WiFi, LAN or 4G.

The USB type COM port at the bottom of the inverter can connect to different kinds of Solis data loggers to realize the remote monitoring on Soliscloud platform.

To install Solis data loggers, please refer to corresponding user manuals of Solis data loggers.

The Solis data loggers are optional and can be purchased separately.

Dust cover is provided the inverter package in case the port is not used.



WARNING:

The USB type COM port is only allowed to connect Solis data loggers. It is forbidden to be used for other purposes.

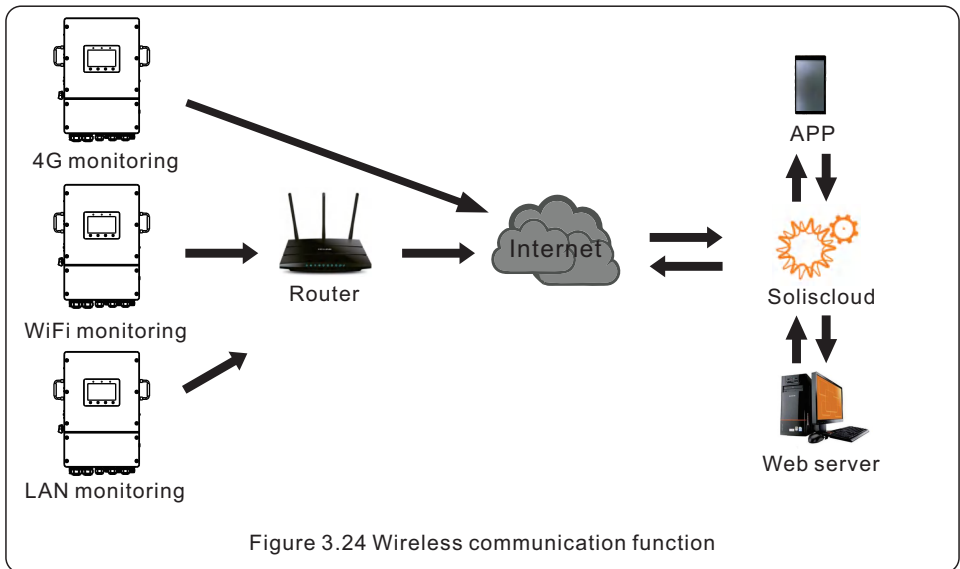
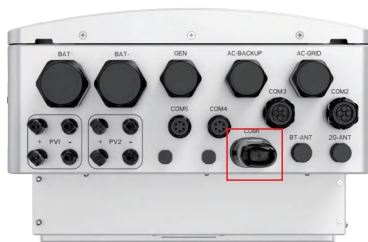

4.1 HMI Screen

There are 3 indicators and 4 operation button on the Solis S6 Series Inverter.

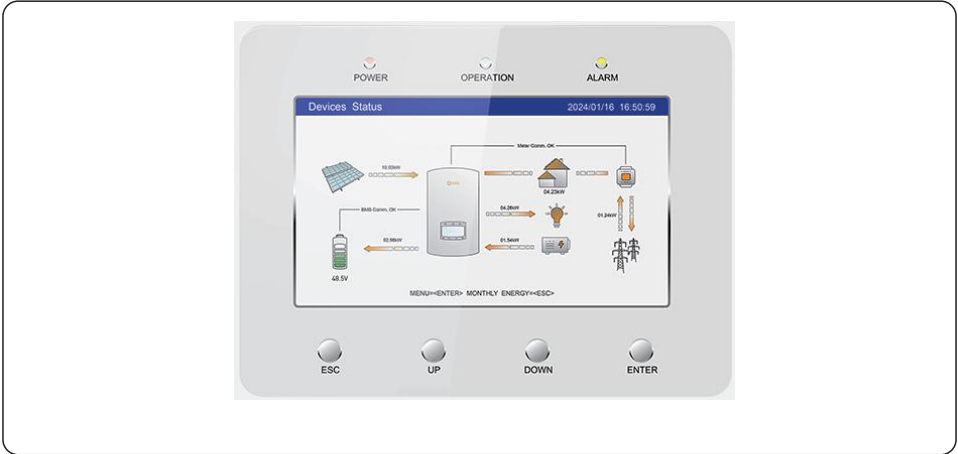

There are three LED indicators on the RHI inverter (Red, Green, and Orange) which indicate the working status of the inverter.



Light	Status	Description
● POWER	ON	The inverter can detect DC power.
	OFF	No DC power.
● OPERATION	ON	The inverter is fully operational.
	OFF	The inverter has stopped operating.
	FLASHING	The inverter is initializing.
● ALARM	ON	Emergency Fault.
	OFF	No fault condition detected.
	FLASHING	Warning and Normal Fault.

Table 4.1 Status Indicator Lights

Description of buttons:



Button	Description
ESC	“Escape”, allows the user to exit, or cancel the operation.
UP	Upwards key, allows the user to increase the value or move forward to the next option.
DOWN	Downwards key, allows the user to decrease the value or move backward to the previous option.
ENTER	Running or executing command .



NOTE:

The screen will be automatically turn off after being idle for a few minutes to save power, click any operation button(“ESC”/“UP”/“DOWN”/ “ENTER”) to restart the screen, then press“Enter”into the main operation interface.

4.2 Inverter built-in Bluetooth description

Bluetooth: BLE

frequency band(s) in which the radio equipment operates:2.402-2.480GHZ

Maximum transmitting power: 8dBm

Hereby, Ginlong Technologies Co.,Ltd.declares that the radio equipment type hybrid inverter is in compliance with Directive 2014/53/EU

5.1 Pre-Commissioning

- Make sure that no high voltage conductors are energized.
- Check all conduit and cable connection points ensure they are tight.
- Verify that all system components have adequate space for ventilation.
- Follow each cable to ensure that they are all terminated in the proper places.
- Ensure that all warning signs and labels are affixed on the system equipment.
- Verify that the inverter is secured to the wall and is not loose or wobbly.
- Prepare a multimeter that can do both AC and DC amps.
- Have an Android or Apple mobile phone with Bluetooth capability.
- Install the Soliscloud APP on the mobile phone and register a new account.
- There are three ways to download and install the latest APP.

- 1.You can visit www.soliscloud.com.
- 2.You can search"Soliscloud" in Google Play or APP Store.
- 3.You can scan this QR code to download Soliscloud.



5.2 Power ON

Step 1: With the DC switch off, energize the PV strings and then measure DC voltage of the PV strings to verify that the voltage and polarity are correct. Turn on the battery and check the battery voltage and polarity as well.

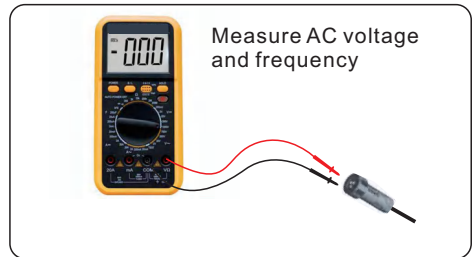
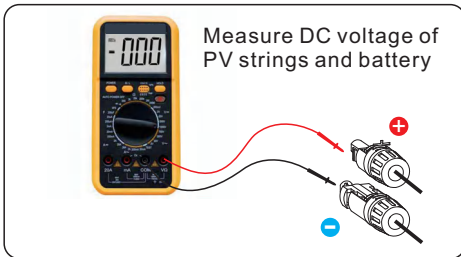

Step 2: Turn on the OCPD for the system and then measure the AC voltages line to line and line to neutral. The backup side of the system will be off until commissioning is complete. Turn the OCPD back off for now.

Step 3: Turn the DC switch on and then the OCPD(AC breaker) for the system. This inverter can be powered on by PV only, battery only and Grid only. When the inverter is powered on,the five indicators will be lighted at once.

5.3 Power OFF

- Step 1: Turn off the AC breaker or AC disconnect switch to disable AC power to the inverter.
- Step 2: Turn off the DC switch of the inverter.
- Step 3: Turn off the battery breaker.
- Step 4: Use a multimeter to verify that the battery and AC voltages are 0V.

5.4 HMI Screen Setting

5.4.1 HMI Quick Setting

If this is the first time the inverter has been commissioned, you will need to first go through the Quick Settings. Once this has been done, these settings can be changed later.

Inverter Time -> Meter Setting -> Grid Code -> Storage mode -> Battery Model

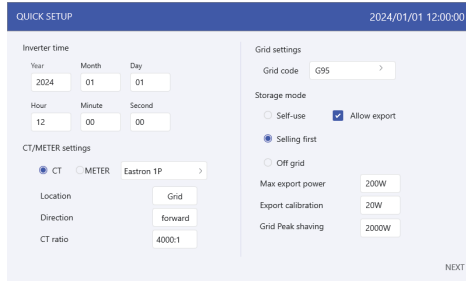

1. Inverter time:

Set inverter time and date, default follow the phone.

2. CT/Meter setting:

Select the CT or Meter, Solis provide Eastron 3 phase meter, it is self-identifiable.

Set installation location: Grid side / Load side / Grid+PV inverter;

CT direction: When CT installed correctly, select "Forward"; when CT installed direction wrong, the sampling current of CT will be reversed when calculating the power, select "Reversal" to correct it.

Set CT ratio: default 60 (Solis provide ESCT-T50-300A/5A CT), if the user install their own CT, then need to set the CT ratio manually. If the system connected to Meter, then CT ratio need to be set on Meter.

3. Grid code:

Select grid code that meet the local regulations.

4. Storage mode:

ALL modes first priority is to use the available PV power to support loads. The different modes determine what the second priority, or use of the excess PV power, will be.

Self-use / Selling first / Off-grid are exclusive, the user could select only one mode.

Mode	Description
Self-use	<p>PV power flow priority sequence: loads > battery > grid. In this mode, the system stores excess PV power into the battery after the loads are supplied.</p> <p>If "Allow export" turned on, when the battery is charged full, or there is no battery, the excess PV power will be exported(sold)back to the grid.</p> <p>If the system is set to not export any power, then the inverter will curtail the PV power (derate the inverter output power).</p>
Selling first	<p>PV power flow priority sequence: loads > grid > battery. In this mode, the system exports any excess PV power after the loads are supplied. If the export power quota has been met, then the remaining PV power will be stored in the battery.</p> <p>Notice: This mode should not be used if export power set to zero.</p>
Off grid	<p>PV power flow priority sequence: loads > battery. This mode only used when the system are not electrically connected to the grid at all. This mode is like Self-Use Mode, but the PV power will be curtailed if the PV power output is > battery power + load power</p>

Table 1 Description of modes

Under each mode, user could set other functions based on their requirements.

Settings	Description
Max export power	<p>Default: 1.1 times of rated power. Notice: if feed-in is not allowed, set Max export power to 0.</p>
Export calibration	<p>Range : -500w-500w, default 20w, settable. To compensate the deviation of CT/Meter in practical application.</p>
Grid peak shaving	<p>Default enable, default 2 times of rated power. Limit the power drawn from the grid to prevent from exceeding regulatory requirements or the power line capacity. It works only when the "battery reserve" turned on.</p>

Table 2 Description of mode settings

5. Battery setting:

Select battery brand.

Set Max charging/discharging current.

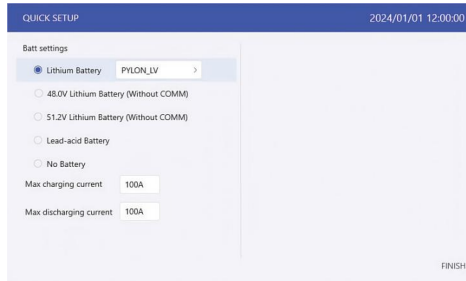

5.4.2 HMI screen operation system overview

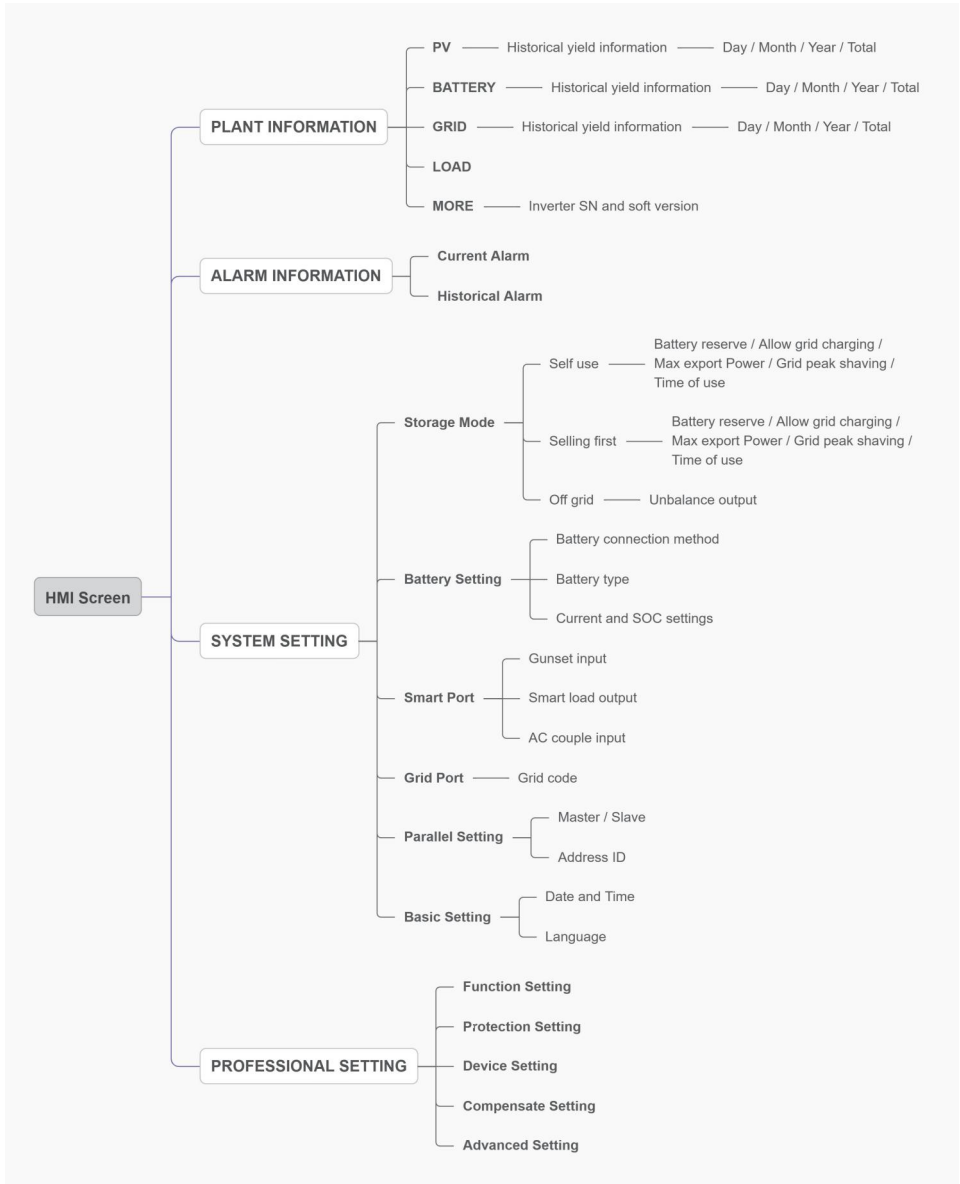

5.4.3 Detailed HMI Setting

Step 1: Enter Home page

After quick setting, press “ENTER”, the screen displays the home page.

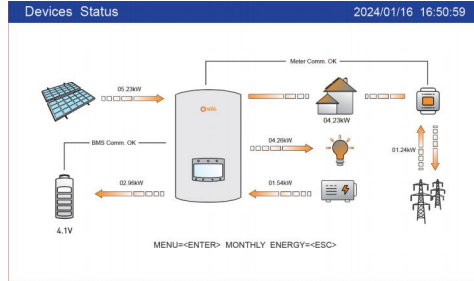

The screen will be automatically turn off after being idle for a few minutes to save power, click any operation button (“ESC”/“UP”/“DOWN”/“ENTER”) to restart the screen, then press “Enter” into the main operation interface.

Step 2: Enter “SYSTEM SETTING” interface

Press “Down” button, then press “ENTER” into the “SYSTEM SETTING” interface.

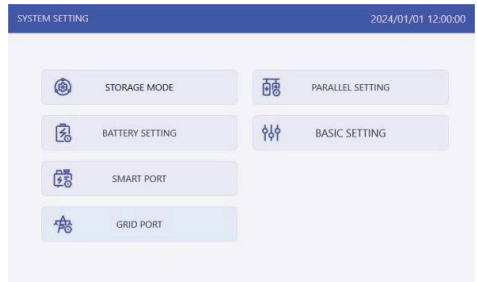

Step 3: Set “Storage Mode”

Use “UP” or “DOWN” key to select the desired mode, then press “ENTER”.

The Mode description please refer to 5.4.1.

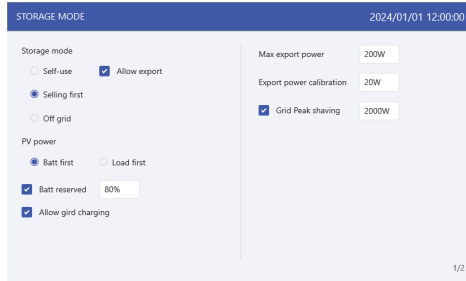

Settings	Description
Battery reserve	Range: 5~95%, default: 80%, settable. When battery SOC < set battery reserve SOC, battery will stop discharging.
Allow grid charging	Allow grid charging the battery when it enables. Notice: if “Allow Grid Charging” is turned on, the inverter will use grid power to charge the battery only under two circumstances: The battery drains to the Force Charge SOC. When PV power output can’t meet the set current value during the charge periods.
Max export power	Default: 1.1 times of rated power. Notice: if feed-in is not allowed, set Max export power to 0.
Export calibration	Range : -500w-500w, default 20w, settable. To compensate the deviation of CT/Meter in practical application.
Grid peak shaving	Default enable, default 2 times of rated power. Limit the power drawn from the grid to prevent from exceeding regulatory requirements or the power line capacity. It works only when the “battery reserve” turned on.

Table 3 Description of storage mode settings

Step 4: Set “Time of use” under each mode (Skip this step if no need)

Time of Use is for manual control of the battery charging/discharging. It is for customizing when the battery is allowed to charge and discharge power and at what rate, established by a current(amperage)setting.

1. Charge period: battery charges with set current value until the charging cut-off voltage (settable), checking the box to control whether enable this charging period.
2. Discharge period: battery discharges with set current value until the discharging cut-off voltage (settable), checking the box to control whether enable this discharging period.

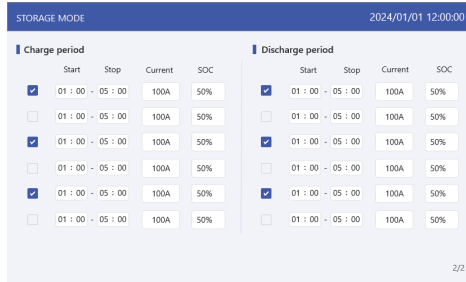

Step 5: Set “Battery Setting”



Settings	Description
Max charge current	Max charge current, settable.
Max discharge current	Max discharge current, settable.
Over discharge	Range: 5~40%, default 20%, when battery SOC < over discharge, it will stop discharging.
Recovery	Range: set Over discharge value +1% ~ set Over discharge value +20%; when battery SOC > Recovery SOC, it will start charging, reserve the return difference value to avoid the battery repeatedly cross jump between charging and discharging.
Force charge	Range: set Over discharge value +1% ~ set Over discharge value +20%; when battery SOC > Recovery SOC, it will start charging, reserve the return difference value to avoid the battery repeatedly cross jump between charging and discharging.
Max charge SOC	Charge cut-off SOC, battery stops charging when reach the Max. Charge SOC.

Table 4 Description of battery mode settings



NOTICE:

Force charge SOC < Over discharge SOC < Recovery SOC, otherwise the setting might be error.

Step 6: Set “Grid Port”

(Skip this step if grid code is already set in quick setting)

Select grid code that meet the local regulations.

Three level of Over-voltage / under-voltage / Over-frequency / under-frequency are default based on grid code, there is no need to set the parameters in manual.

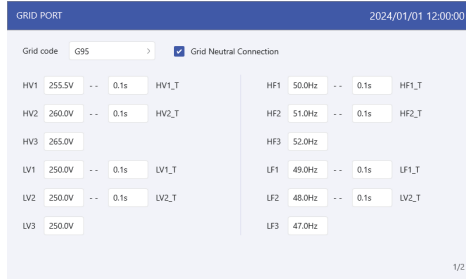

Step 7: Set “Smart Port”

(Skip this step if the system is not connected to generators)

When it is connected to Generator, select “Gunset input”;

When it is connected to smart load like heat pump, select “Smart load output”

When it is connected to Grid-tied inverter, select “AC coupled”

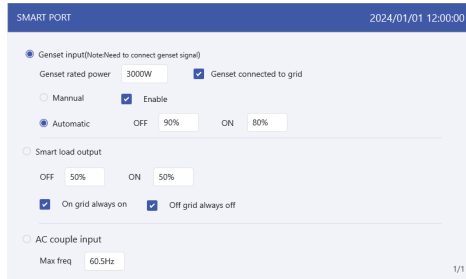

Gunset

The user need to input the “Gunset rated power” by manual.

OFF: Generator stops charging SOC, settable, range:35~100%;

ON: Generator start charging SOC; settable, range:1~95%;

AC coupled:

OFF: Grid-tied inverter stops charging SOC, settable, range:35~100%;

ON: Grid-tied inverter start charging SOC; settable, range:1~95%;

Step 8: Set parallel system

Set Master and Slave machine,

Set Master ID as: 1

Slave machine ID as: 2

.Slave machine ID as: 3

..... and so on.



5.5 Log in the APP via Bluetooth

Step 1: Connect with Bluetooth.

Turn on Bluetooth switch on your mobile phone and then open the SolisCloud APP. Click "More Tools" -> "Local Operation" -> "Connect with Bluetooth"

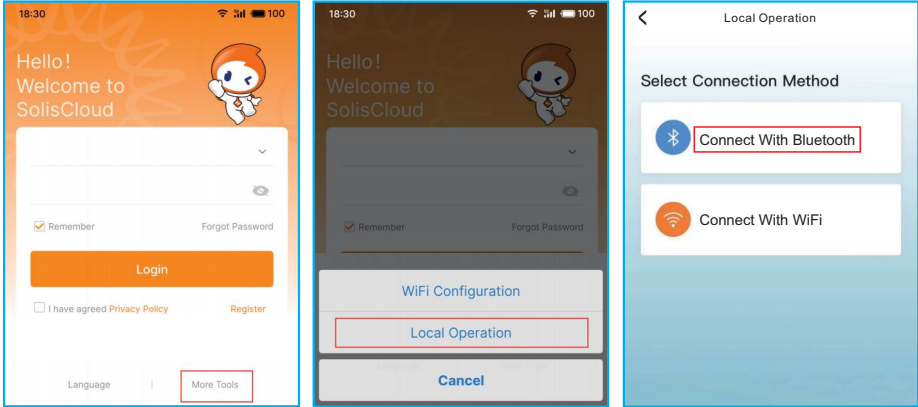

Step 2: Select the Bluetooth signal from the inverter. (Bluetooth Name: Inverter SN)



Step 3: Login account.

If you are the installer, please select the account type as Installer. If you are the plant owner, please select the account type as Owner. Then set your own initial password for control verification. (The first log-in must be finished by an installer in order to do the initial set up)

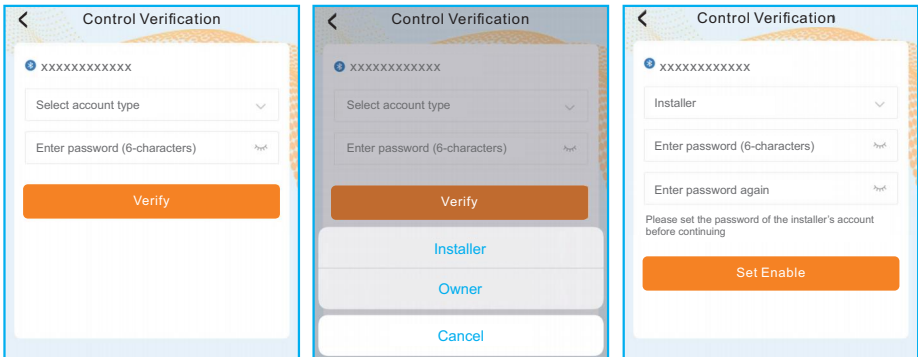

Step 4: After the log in for the first time, initial settings are required.

Step 4.1: Set the inverter date and time.

You can set to follow the time on your mobile phone.

Step 4.2: Set the battery model.

It must be based on the battery model that is actually connected to the inverter. If there is no battery connected for the moment, please select “No Battery” to avoid alarms.

The default setting for battery over discharge SOC is 20%, force charge SOC is 10%.

Step 4.3: Set the meter setting.

It must be based on the meter type that is actually connected to the inverter. If the grid does not need to be connected to an N-Line, select disconnected. If there is no meter connected for the moment, please select “No Meter” to avoid alarms. It is suggested to install the meter at the system grid connection point and select “Meter in Grid”.

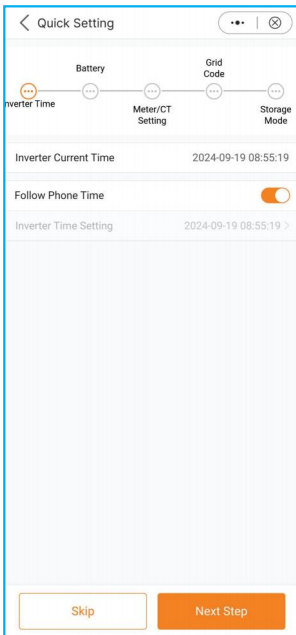

Step 4.1

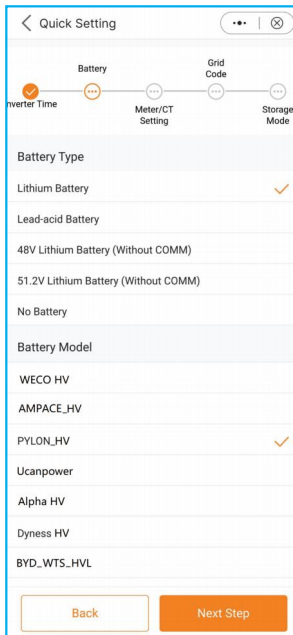

Step 4.2

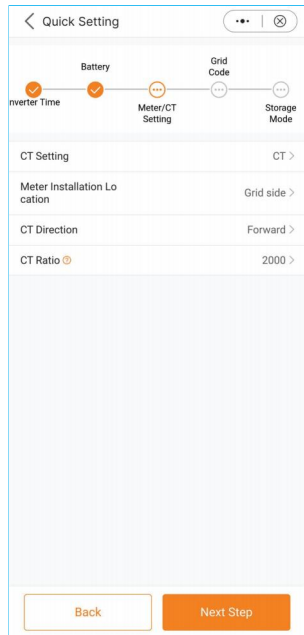

Step 4.3

Step 4.4: Set the grid code setting.

Please select the grid code based on the local grid network requirements.

Step 4.5: Set the work mode setting.

Recommended setting is Self-Use Mode. This mode will maximize the use of PV power generation for household electricity, or store it in batteries and use it for household electricity.

Allow export: Allow power output to the grid in Self-use mode. If you do not want to send power to the grid, do not turn it on.

Max export power: Limit the maximum power sold to the grid.

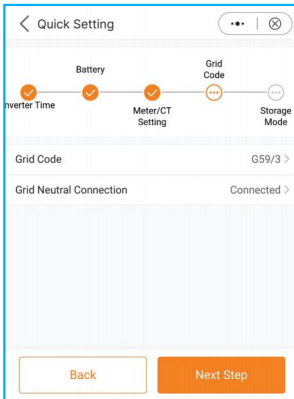

Step 4.4

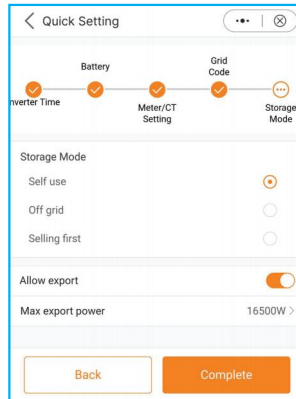

Step 4.5

Step 5: Setup complete.

Now the initial settings on the inverter have been set and you can switch on the inverter's DC switch and switch on battery breaker to start up the system. You can also explore in the APP to check the operating data, alarm message or other advanced settings.

5.6 Shutdown procedure

- Step 1. Turn off the AC breaker at the grid connection point.
- Step 2. Turn off the DC switch of the inverter.
- Step 3. Turn off the battery breaker.
- Step 4. Wait until the device is powered off, and the system shutdown is complete.

5.7 Work Mode and Settings

APP operation system overview

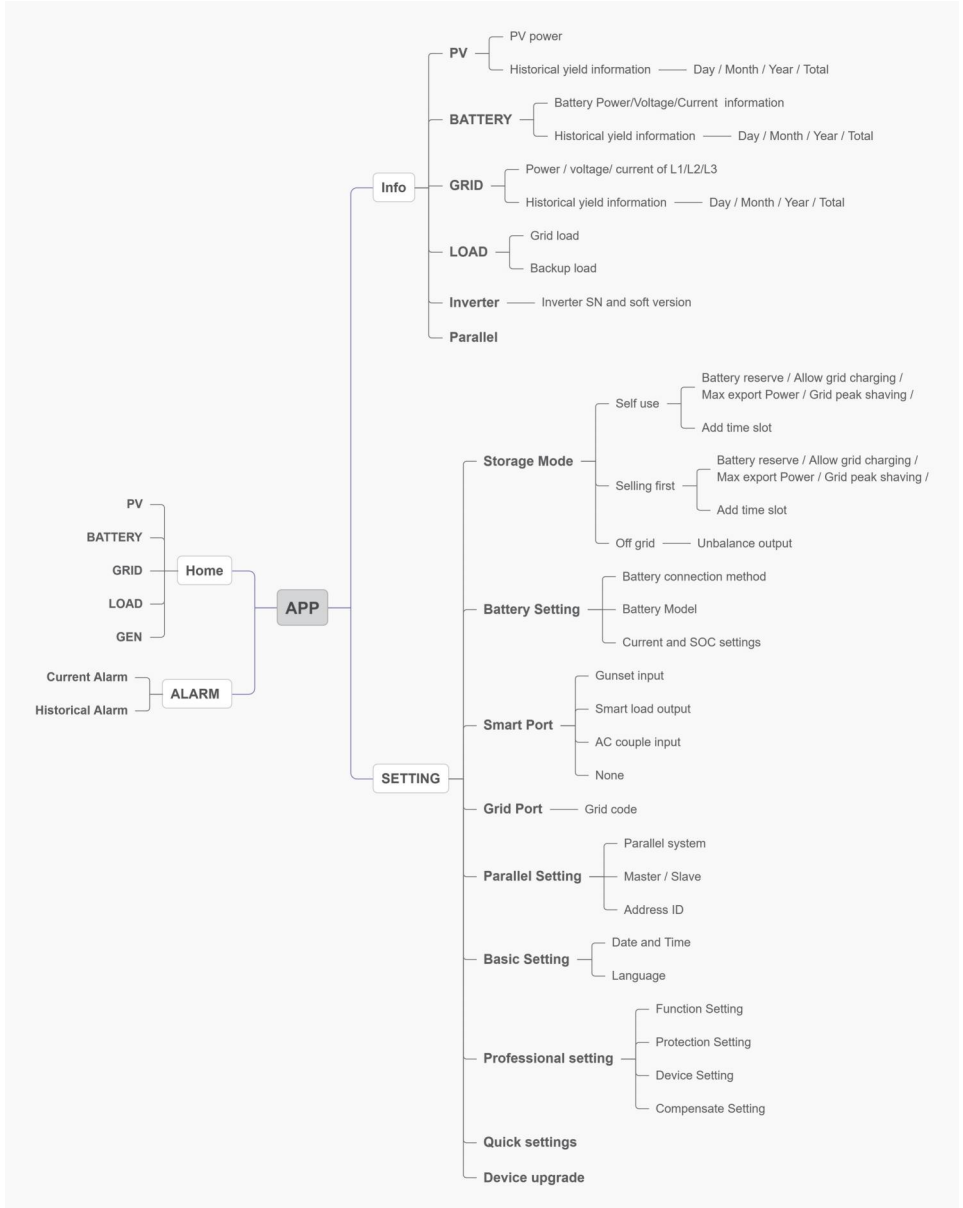

5.7.1 Self-Use mode

Load priority: load>battery>grid

Power supply priority: PV>battery>grid>DG

This mode applies to the area that has low feed-in tariff and high energy price.

The PV power will prioritize supplying energy to the load and charging the battery, with any surplus power being fed into the grid. During periods without PV power at night or when the PV power is insufficient, the battery will discharge to support the load.

- Supports TOU settings in this mode.
- Supports Battery Reserve function in this mode.

How to set Self-Use mode?

APP: setting--storage mode-self use

A. Self-Use Mode is activated without any specific times set for the battery to be charged/discharged, and the battery reserve is not switched on.

Note: Solis recommends activating the 'Allow Grid Charge' option. Once the battery reaches the Forcecharge SOC, it will use the grid to charge the battery, preventing it from being deep discharged.

B. The Self-Use Mode provides you with the option to set a Battery reserve value. Please toggle the switch to activate the battery reserve mode.

C. The Self-Use Mode provides you with the option to set whether allow power output to the grid and the max value.

D. If there is an error with your meter or CTs, open "Export power calibration" to calibration; In addition, you can set a small negative value(like:-50W)to ensure that no power is sent to the grid to achieve Zero export Power.

E. When your load is unbalanced in the three-phase distribution, turn on unbalanced output. Supports 150% Unbalanced Loads on both the Grid and Backup Port, single-phase load 1/2 rated power.

F. You can set the value of Grid peak shaving, Limit the power that inverters can obtain from the grid to prevent exceeding regulatory requirements or the power line capacity due to excessive power.

G. With the Add time slot, you can customize 6 stages of charging and 6 stages of discharging in one day.

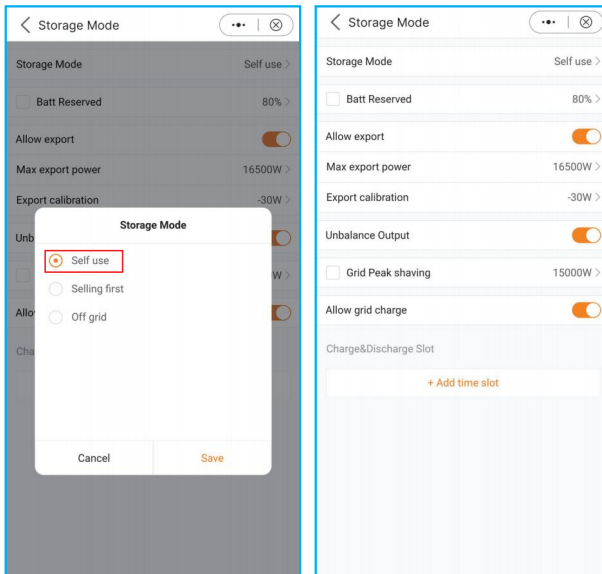

Batt reserved: Lithium battery: default 80%, adjustable range (the recommended value is more than 80%, to ensure that the battery has enough energy to supply the load after the grid is off ;

Lead acid battery: Default 100%, cannot be set.

Allow export: Allow power output to the grid in Self-use mode. If you do not want to send power to the grid, do not turn it on.

Max export power: Limit the maximum power sold to the grid.

Export power calibration: As some CTs/meters may have errors in practical applications, this setting value can be used for compensation. The range is "-500w ~ +500w"

Unbalanced output: Allow three-phase output imbalance, single-phase maximum load 50% of rated power.

Grid peak shaving: Limit the power that inverters can obtain from the grid to prevent exceeding regulatory requirements or the power line capacity due to excessive power.

When the grid supplies power to the load while charging the battery, it will limit the power used to charge the battery, so that the total power does not exceed the set value.

If the grid only supplies power to the load and does not charging the battery, it is not limited by the setting value.

Allow grid charging: Allow the battery to be charged by the grid.

Charge/Discharge Slot: When the time is between Start and Stop, the system will charge/discharge the battery according to the set Current until the set "SOC/voltage" is reached.

5.7.2 Selling first mode

Load priority: load>grid>battery

Power supply priority: PV>battery>grid>DG

This mode applies to the area that has high feed-in tariff and export control.

The PV power will prioritize supplying energy to the load. Then any surplus is directed into the grid.

If there is a feed-in limitation, the excess power will charge the battery.

- Supports TOU setting in this mode.
- Supports Battery Reserve function in this mode.

How to set selling first mode?

APP: setting--storage mode--selling first

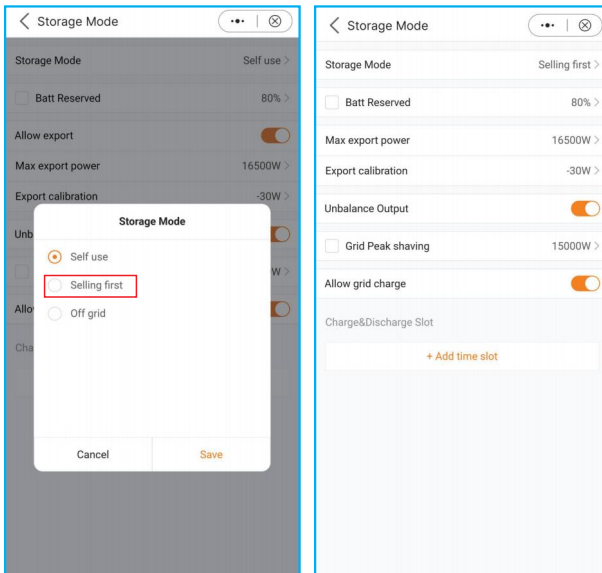

5.7.3 Off-Grid mode

Load priority : load>battery

Power supply priority: PV>battery>DG

- This mode applies to the area not covered by the grid or when the system is not connected to the grid.
- When a power outage is detected in a grid-tied system, the system will automatically will automatically enter in the off-grid, supplying only the backup load.
- The user can also manually set this mode, supplying only the backup load.

How to set Off-Grid mode?

APP: setting--storage mode--off-grid

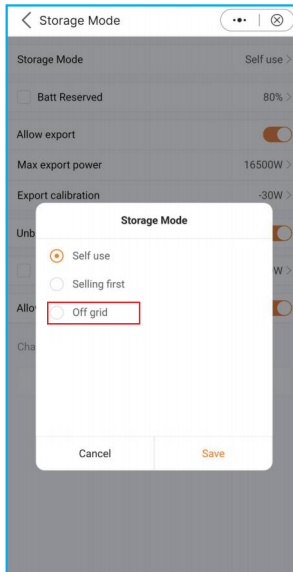

5.8 TOU Function Settings

This function applies to the area with peak-valley price. Set the system to charge the battery in valley price and discharge in peak price to improve benefits.

Supports 6 customizable charge/discharge time settings, while the battery will charge/discharge at a set current.

Supports TOU function settings in self-use mode, feed in priority mode.

There are 6 customizable charging settings and 6 customizable discharging settings.

How to set TOU Function?

Press "+Add Time Slot" to add a charging/discharging time period.

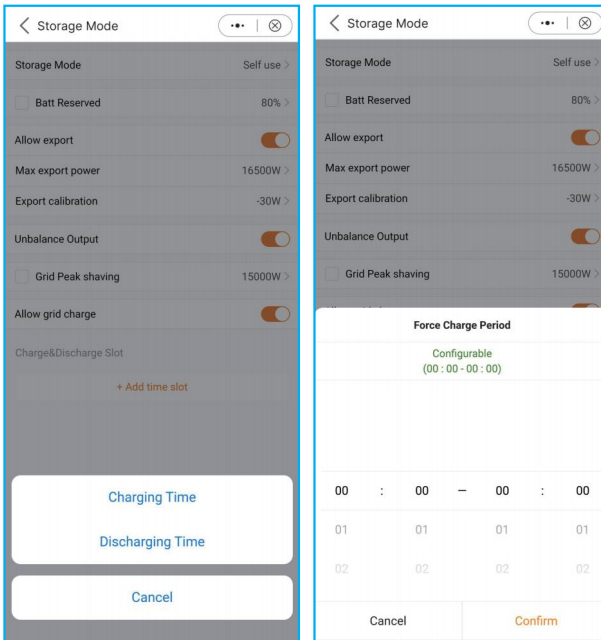

5.9 Battery Settings

The battery section of the app offers numerous options to customize the interaction between the inverter and the battery. Here, we provide explanations for the functions and features available in this section, allowing users to tailor the inverter's behavior to their specific preferences and requirements.

Battery Type: Please select the correct Type of the battery. Lead-acid battery and lithium battery.

Battery Mode: Please select the correct model of the battery. If you don't have a battery, choose "No battery" to ensure accurate configuration.

Max Charging/Discharging Current: Choose the maximum charge/discharge current that you wish to. This selection allows you to customize the charging and discharging parameters based on your preferences and requirements.

Overdischarge SOC: The Overdischarge SOC (State of Charge) is the minimum battery charge level to which the inverter will discharge. It acts as a safeguard to prevent the battery from discharging beyond this specified threshold, ensuring its longevity and health.

Recovery: The battery can discharge when the SOC/Voltage reaches the set value.

Forcecharge: The Forcecharge SOC for the battery is the minimum state of charge(SOC) at which the inverter initiates charging the battery from the grid. It specifies the threshold below which the inverter actively engages in recharging the battery to maintain optimal performance.

Battery saving: Reduce battery loss. The necessary power for the operation of the inverter preferentially obtains from the grid, not from the battery.

Max charge SOC: The maximum SOC/Voltage that the battery can be charged to. Default 100%. Some batteries may alarm overvoltage when fully charged, and limiting protection will not be triggered if not fully charged.

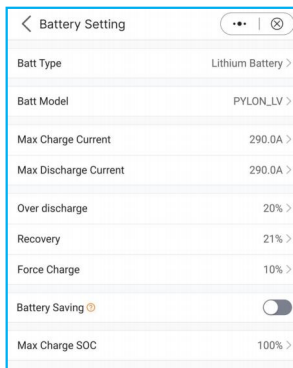

5.10 Battery Functions setting

If you need more Function Settings for the battery, you can go to Setting--Professional Setting--Function Setting.

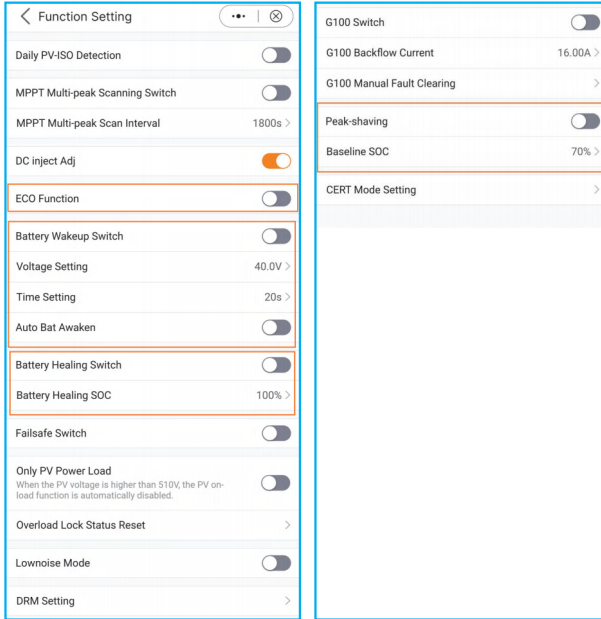

ECO function: To protect the battery, If PV power is lower than 100W and SOC below overdischarge SOC, The inverter will take power from the grid instead of battery, to maintain standby state, indicator and communication.

Battery Wakeup Switch: Battery wake-up can be supported in case of only PV or only Grid. This function supports manual and automatic operation, the battery can be awakened from the dormant state and charged above the overdischarge SOC.

Wake up voltage&time can be set:

Voltage: default 120V, range :120-600V;

Time: default 180s,range :20s-300s;

The wake up current depends on the battery, up to 6A.

Battery Healing Switch: When the lithium battery maintains low power for a long time, the battery SOC measurement is not accurate, It is necessary to charge the battery to 100 % from low power level to ensure the healthy and stable operation of the battery. Working logic: PV+grid charge the battery from Forcecharge SOC to overdischarge SOC , then grid stops charging, PV gives priority to charging the battery to Battery Healing SOC. And the battery does not discharge before reaching the set Battery Healing SOC.

Battery Peak shaving: In this function, the force charge power will be dynamically adjusted and not exceed the set value minus the load power when force charging.

5.11 Smart port settings

5.11.1 Generator setting

APP: setting--Smart Port

In single system, Diesel Generator can be connected via GEN port or ATS on Grid side. If though GEN port, it will only supply power to the Backup load. It is recommended that the power be greater than the backup load power.

If it is necessary to supply power to the grid side load, it is recommended that the generator be connected through ATS on grid side;

In parallel-system scenarios, connecting DG via ATS is recommended, Gen port is also supported;

When the generator is connected to the system, it is necessary to correctly select the location of the generator to avoid system failure or generator damage.

A. Select Genset input

B. Set the Genset rated power.

C. When you want to manually control the start and stop of the generator, enable needs to be selected.

D. When you want the generator to automatically start and stop according to the battery SOC, please select the Automatic.

The generator will start when the battery SOC drops to the ON SOC, and stop when the SOC reaches the OFF value.

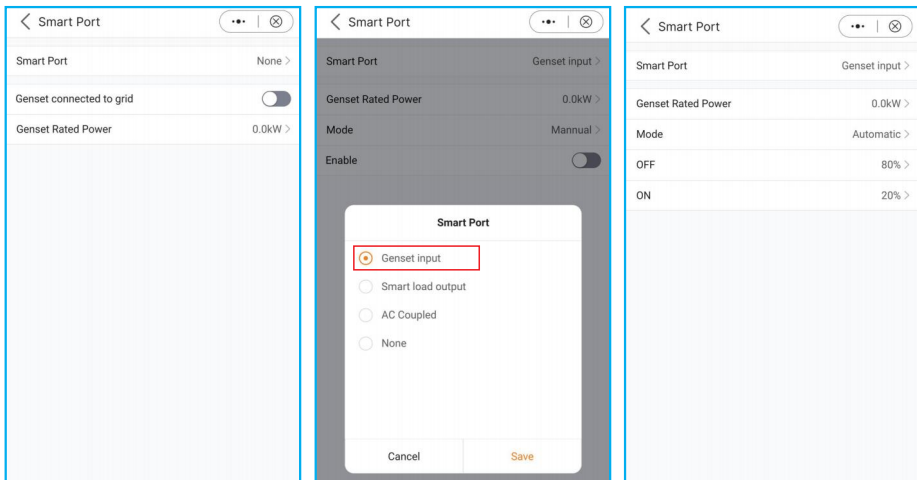

5.11.2 AC coupled setting

APP: setting--Smart Port

With an existing PV plant connected to the system, it is recommended that:

Grid-tied inverter power < rated AC power of S6 inverter.

In an on-grid scenario, when the third-party grid-connected inverter is connected, the system cannot control the output power of the third-party grid-tied inverter, so feed-in limitation cannot be achieved;

When connected in off-grid scenario, the third-party grid-tied inverter needs to set the correct grid code, and has the function of over-frequency load shedding & under-frequency load rising, so that the system can adjust the frequency to control the output power of the grid-tied inverter.

When the system is connected to the generator, it cannot be connected to the grid-tied inverter, as there's a risk of damaging the generator.

A. Select the AC couple input.

B. Set the Max frequency according to the specification of the PV inverter.

The hybrid uses Freq-Watt to control the output of the PV inverter. Please consult with the PV inverter's manufacturer to confirm the correct setting procedures of its Freq-Watt response first.

When $SOC \leq 70\%$, start inverter, when $SOC \geq 85\%$, Hybrid raises the frequency to the set value, stop inverter.

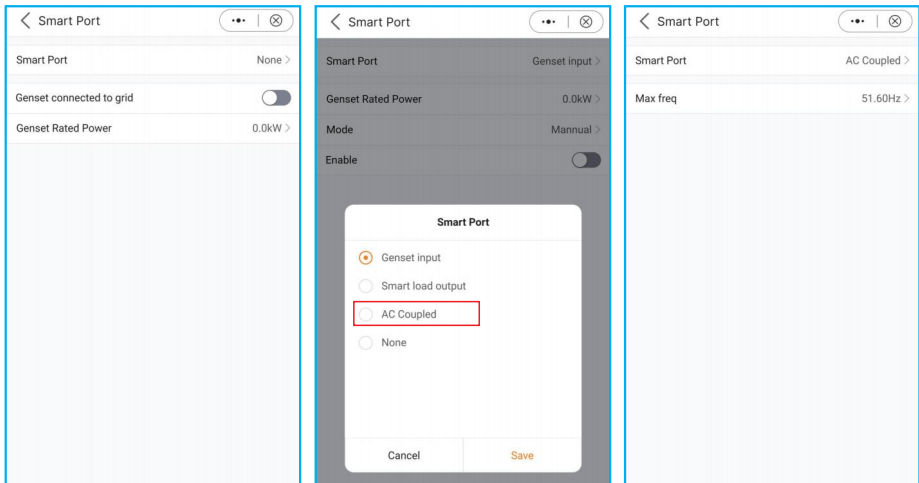

5.11.3 Smartload setting

APP: setting--Smart Port

The Gen port has extended power, which can be used as Smart load output. When the battery SOC/Volt reach the ON set value, the smart port will supply power to the load. When the battery SOC/Volt drops to OFF SOC/Volt, it will cut off the power of the load.

A. Select Smart load output.

B. Select On grid always on or Off grid always off

On grid always on: smart port will always supply power to smart load when the grid is available.

Off grid always off: smart port will cut off power supply to smart load when the grid is off.

C. Set the OFF value and ON value to control the on/off of the load based on the battery level.

When the battery SOC/Volt drops to the OFF SOC/Volt, the system will cut off the power of smart load to ensure sufficient power for Backup load. When the battery SOC/Volt reaches the ON SOC/Volt, the smart port will supply power to smart load.

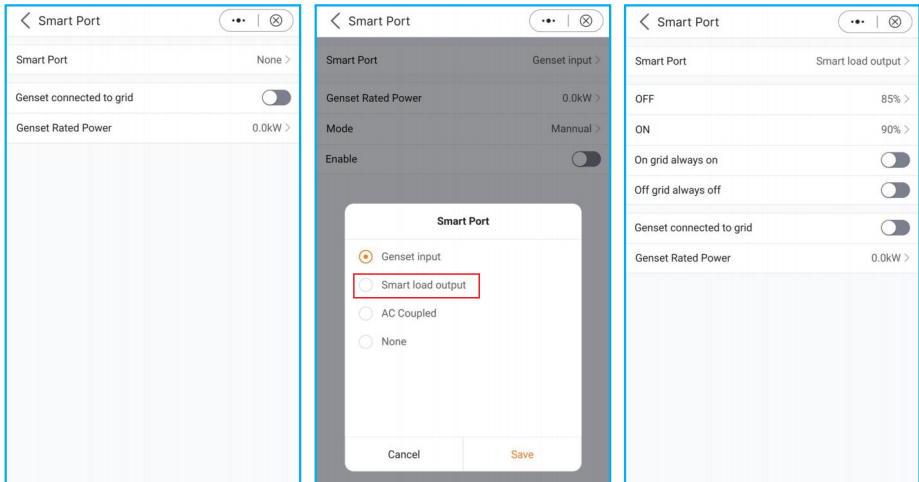

5.12 Grid port settings

APP: setting--Grid Port

Select grid code that meet the local regulations; If the grid is three-phase and three-line, choose Disconnected the N-line.

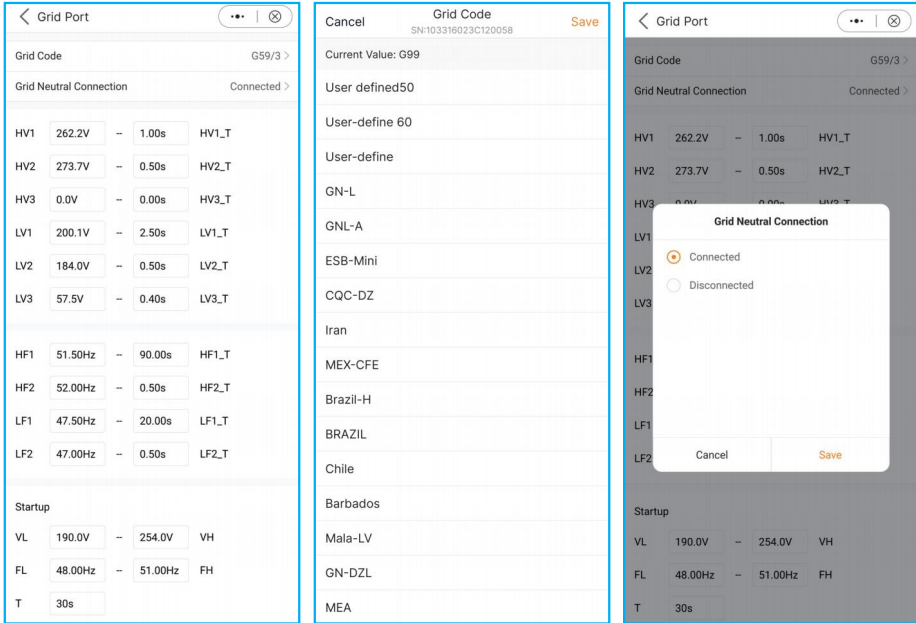

5.13 Parallel Settings

APP: setting--Parallel setting

The first inverter must be set as the Master.

The first inverter address is set to 1, the second to 2, and so on

(Note: that the address cannot be set to 0 and the physical address of the master must be 1)

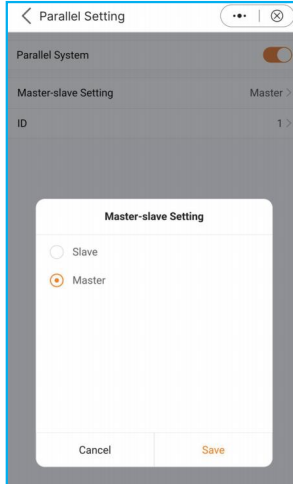

5.14 Only PV power load function

1. Function Definition

For PV generation is not stable, the default setting of S6 energy storage machine don't support only PV power the load.

But for meeting the some customers' special requirements, we develop the **Only PV Power Load** function, when the PV power > the load power, you can use this function.

Because the PV power is not stable and the load is also not always stable, it is possible to happen that PV power < load power, when it occurred, the load will shut down and **after 3 minutes**, the inverter tries to restart the load for the first time, **after 5 minutes**, the second time, and **after 10 minutes**, the third time. If the third attempt to restart the load is still not successful, the inverter will not try to restart, and it needs to be manually reset and restarted.



NOTE:

1. Only PV Power Load function is closed by default. If you need to use it, you need to open it by yourself.
2. Software: Ensure that the current DSP and HMI software is the latest version.

2. Solis APP Setting

Setting--Professional Setting--function Setting

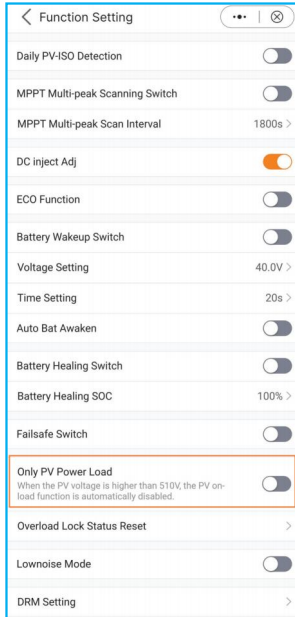

5.15 Initial set up

If this is the first time the inverter has been commissioned, you will need to first go through the Quick Settings. Once this has been done, these settings can be changed later.

Inverter Time -> Battery Model -> Meter Setting -> Grid Code -> Work mode

A. Inverter Time: Set the Inverter Time and Date. It may be easier to tap the slider next to "Follow Phone Time". Then tap Next in the top right corner. This will set the inverter to match your phone.

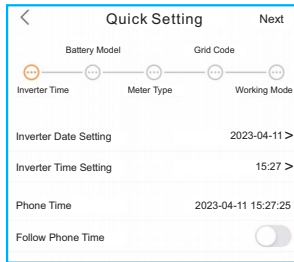

B. Battery Model: Now select the battery model connected to the inverter. This choice must be based on the battery model that is actually connected to the inverter. If there is no battery connected for the moment, select "No Battery" to avoid potential alarms codes.

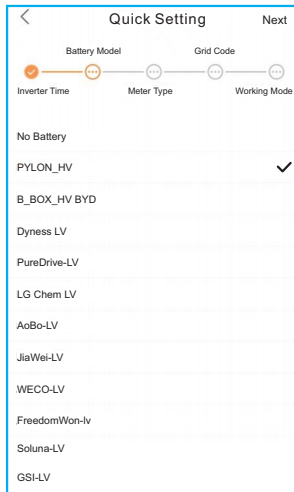

C. Meter Setting: Set both the Meter Type and the Meter Location. It is suggested to install the meter at the system grid connection point and select “Meter in Grid”. If there is no meter connected for the moment, please select “No Meter” to avoid alarms.

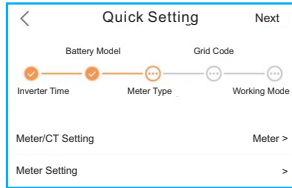

D. Grid Code: Please select the grid code based on the local grid network requirements.

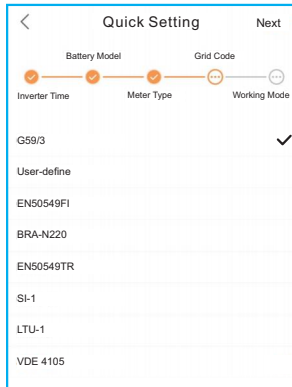

E. Work Mode: This is the energy storage operating mode. ALL modes first priority is to use the available PV power to support the home loads. The different modes determine what the second priority, or use of the excess PV power, will be. Select the desired mode, then tap the slider switch to turn the mode on. The switch will appear orange if it is enabled.

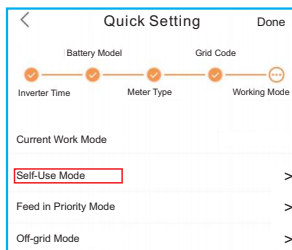

Self-Use Mode stores the excess PV power into the battery. If the battery is charged, or there is no battery, the excess PV power will be exported(sold)back to the utility company. If the system is set to not export any power, then the inverter will curtail the PV power(derate the inverter output power).

Feed in Priority Mode will ensure that the system exports any excess PV power after the home loads are supplied. If the export power quota has been met, then the remaining PV power will be stored in the battery. This mode should not be used if export power is going to be set to zero.

Self-Use Mode		Feed in Priority Mode	
Self-Use Mode Switch	<input type="checkbox"/>	Feed in Priority Mode Switch	<input checked="" type="checkbox"/>
Time of Use Switch	<input type="checkbox"/>	Time of Use Switch	<input checked="" type="checkbox"/>
Time of Use Charge Current Set	50.0A >	Time of Use Charge Current Set	135.0A >
Time of Use Discharge Current Set	50.0A >	Time of Use Discharge Current Set	135.0A >
Charge Time Slot 1	22:00 ~ 08:00 >	Charge Time Slot 1	00:00 ~ 01:00 >
Discharge Time Slot 1	08:00 ~ 22:00 >	Discharge Time Slot 1	01:00 ~ 02:00 >
Charge Time Slot 2	00:00 ~ 00:00 >	Charge Time Slot 2	02:00 ~ 04:00 >
Discharge Time Slot 2	00:00 ~ 00:00 >	Discharge Time Slot 2	04:00 ~ 06:00 >
Charge Time Slot 3	00:00 ~ 00:00 >	Charge Time Slot 3	06:00 ~ 10:00 >
Discharge Time Slot 3	00:00 ~ 00:00 >	Discharge Time Slot 3	10:00 ~ 11:00 >
Charge Time Slot 4	00:00 ~ 00:00 >	Charge Time Slot 4	11:00 ~ 14:00 >
Discharge Time Slot 4	00:00 ~ 00:00 >	Discharge Time Slot 4	14:00 ~ 17:00 >
Charge Time Slot 5	00:00 ~ 00:00 >	Charge Time Slot 5	17:30 ~ 18:00 >
Discharge Time Slot 5	00:00 ~ 00:00 >	Discharge Time Slot 5	18:00 ~ 22:55 >
Charge Time Slot 6	00:00 ~ 00:00 >	Charge Time Slot 6	23:00 ~ 23:30 >
Discharge Time Slot 6	00:00 ~ 00:00 >	Discharge Time Slot 6	23:30 ~ 00:00 >
Allow Grid Charging	<input checked="" type="checkbox"/>	Allow Grid Charging	<input checked="" type="checkbox"/>
Backup Mode Switch	<input type="checkbox"/>	Backup Mode Switch	<input type="checkbox"/>
Reserved SOC	80% >	Reserved SOC	80% >

Off-Grid Mode is only to be used by systems that are not electrically connected to the grid at all. This mode is like Self-Use Mode, but the PV power will be curtailed if the battery is charged and the home load demand is lower than the amount of available PV power.

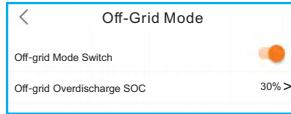

Peak-shaving Mode: Peak-shaving function is possible to set the maximum power (P_{max}) that the system obtains from the main grid. The power of the main grid charges batteries and supplies power to the load, which is within (P_{max}). When the load power exceeds the set maximum power (P_{max}), the insufficient part is provided by the battery. At the same time, users can set the Peak SOC and charge the battery to this SOC as far as possible under the premise of satisfying P_{meter} .

(Tips: Only the lithium battery with CAN connection support the peak-shaving mode)

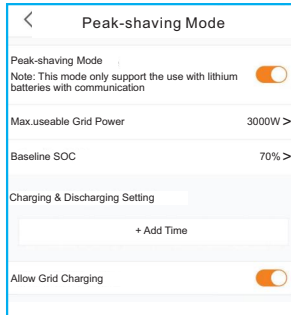

Backup Mode can be opened in the Self-Use or Feed in Priority Mode. What this mode does is ensure that the battery does not drain past the Reserve SOC(state-of-charge) percentage. The battery will cycle between 100% and the Reserve SOC, so if grid power is lost, the battery will have the Reserve SOC at the very least to carry the home through the outage.

Time of Use Switch is for customizing when the battery is allowed to charge and discharge power and at what rate, established by a current(ampere) setting. If this slider switch is turned on, the inverter will only use this schedule to determine when to charge and discharge the battery. If Allow Grid Charging is turned on, the inverter will use grid power to charge the battery only under two circumstances: (1) the battery drains to the Force Charge SOC. (2) Time of Use is enabled and there is not enough available PV power during the charge window to meet the current rate that is established.

Time of Use is for manual control of the battery charging/discharging. If Time of Use is turned off, charging/discharging is automatically regulated by the inverter.

AC Coupling Scheme

Customers can integrate a new energy storage inverter (S6 Hybrid) to an existed Grid - tied inverter system. Users can select two ways of AC Coupling connection modes. One is connect the Grid -tied inverter to S6 inverter Gen port and another is on the backup Port. (Tips: When the total system is at on-grid status, the grid-tied PV inverter MUST be connected to the backup port of hybrid inverter.)

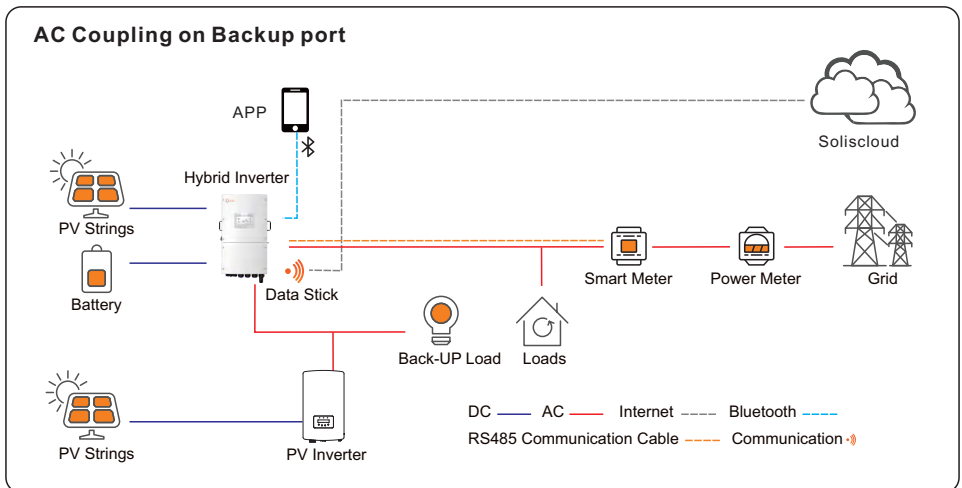

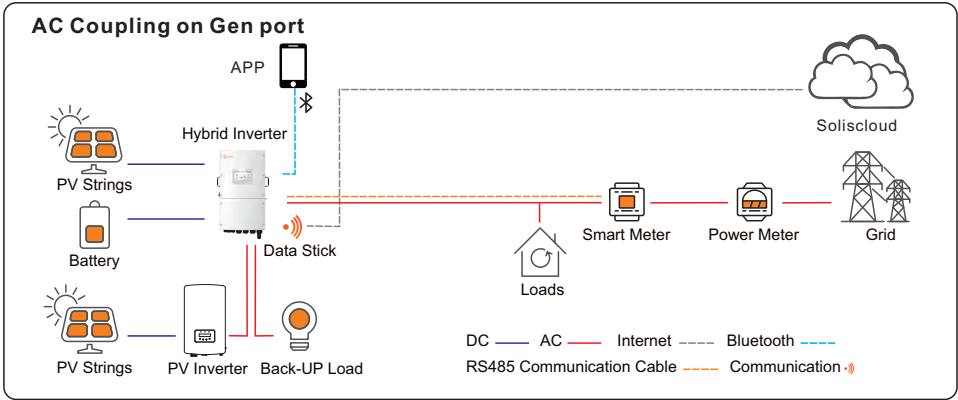

The settings about AC coupling under the smart port setting. When the AC Coupling switch is turned on, customer should set the position is GEN port or Backup port. and set the AC_Coupling_OFF_SOC and AC_Coupling_OFF_VOLT and AC_Coupling Max.fre.

AC_Coupling_OFF_SOC : When the lithium SOC rises to this set value, the grid-tied inverter stops working through load reduction.

AC_Coupling_OFF_VOLT: When the lead acid Volt rises to this set value, the grid-tied inverter stops working through load reduction.

AC_Coupling Max.fre: Default value 52Hz, when the system reaches the grid-tied inverter shutdown condition, the system frequency changes to the set value and overfrequency load reduction is carried out.

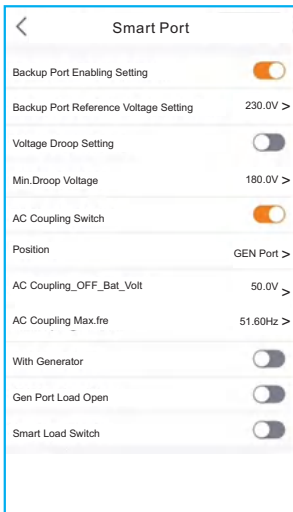

For Lead-acid battery Type

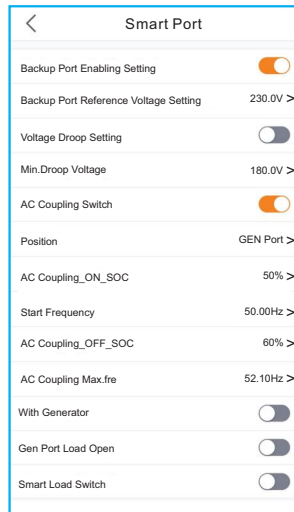

For Lithium Battery Type

5.16 APP Interface

5.16.1 APP Interface Structure

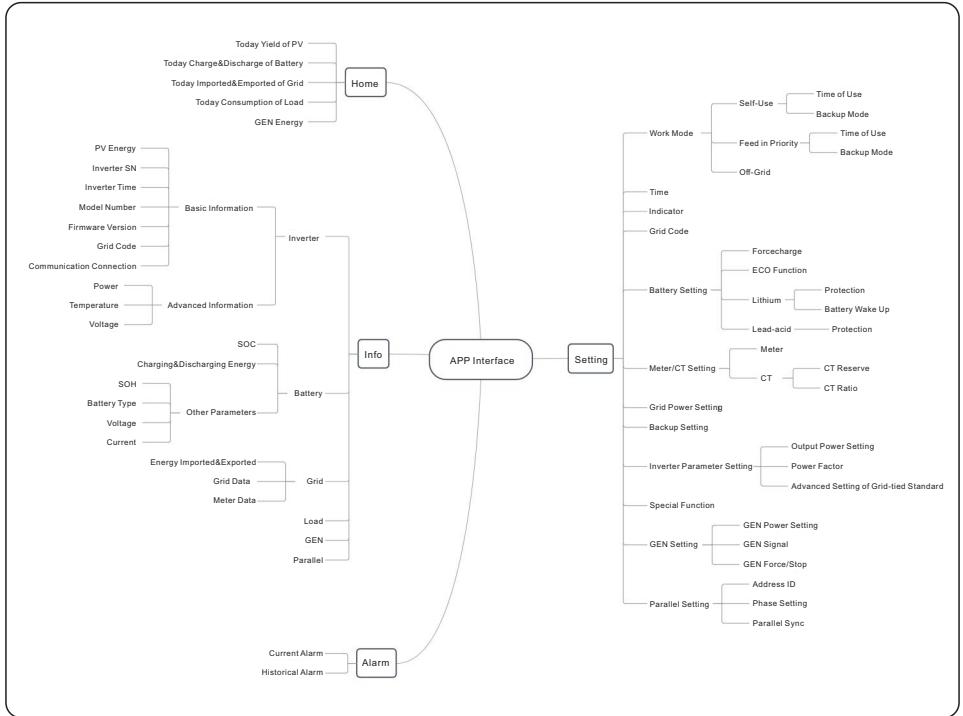

5.16.2 Home

The home page can display the working state, Today Yield of PV, Today Imported/Exported of Grid, Today Charged/Discharged of Battery ,Today Consumption of household electricity and Today GEN yield. At the bottom of page are four submenus: Home, Info, Alarm and Settings.

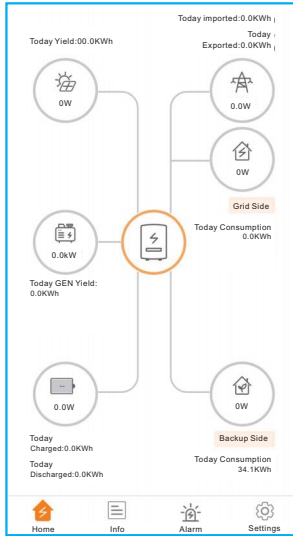

5.16.3 Information

The Info page breaks down into four categories: Inverter, Battery, Grid, and Load.

Inverter: inverter power production history, PV voltages and currents, inverter information (serial number, model number, and firmware version), grid code, and alarm code history.

There are two additional information in the inverter page:

GEN Information: generator power, today and total generator yield, and warning information.

Parallel Information: information includes inverter, battery, grid and load.

Battery: battery model and status, battery voltage and current.

Grid: power imported an exported, AC grid voltage, frequency, and amperage.

Load: power being consumed by the home loads and backup loads.

Inverter	Battery	Grid	Load
Total Yield		221kWh	
14.2kWh	191kWh	221kWh	
Today Yield	This Month Yield	This Year Yield	
12.8kWh	30kWh	0kWh	
Yesterday Yield	Last Month Yield	Last Year Yield	
View Historical Yield >			
Total PV Input Power		865W	
	Voltage	Current	Power
Pv1	432.6V	2.0A	865.20W
Pv2	0.0V	0.0A	0.00W
Inverter SN	103115022B100041		
Inverter Time	2022-12-23 15:32:03		
Rated Power	6kW		
Model Number	3115		
DSP Firmware Version	V2		
HMI Firmware Version	V1		
HMI Firmware Subversion	Vd		
Grid Code	G59/3		
Communication Connection	>		
Advanced Information	>		

Inverter	Battery	Grid	Load
49W Discharge Power		99% Battery SOC	
Charged		Discharged	
Today	6.8kWh	0.2kWh	
Total	1830kWh	1536kWh	
Other Parameters(From BMS)			
Battery SOH		100%	
Battery Model		Dyness LV	
BMS Status		Normal	
Battery Voltage BMS		50.28V	
Battery Current BMS		0.0A	
BMS Charge Current Limit		10.0A	
BMS Discharge Current Limit		75.0A	
Other Parameters(From inverter)			
Battery Voltage		49.8V	
Battery Current		1.0A	
OverVoltage Protection Value		60.0V	
UnderVoltage Protection Value		42.0V	
Battery Equalization Voltage		53.5V	

Inverter	Battery	Grid	Load
	Exported	Imported	
Today	0.0kWh	0.0kWh	
Yesterday	0.0kWh	0.0kWh	
Total	1kWh	0kWh	
Grid Data			
Power		-1399W	
Voltage		220.8V	
Frequency		49.95Hz	

Inverter	Battery	Grid	Load
Grid Side			
Grid Load Power(Active)		0W	
Total Grid Load Consumption		0kWh	
Today Grid Load Consumption		0.0kWh	
This Month Grid Load Consumption		0kWh	
This Year Grid Load Consumption		0kWh	
Backup Side			
Backup Load Power(Active)		2119W	
Total Backup Load Consumption		1527kWh	
Today Backup Load Consumption		34.2kWh	
This Month Backup Load Consumption		1202kWh	
This Year Backup Load Consumption		1527kWh	

5.16.4 Alarm

The alarm page can display the current alarm and the historical alarm.

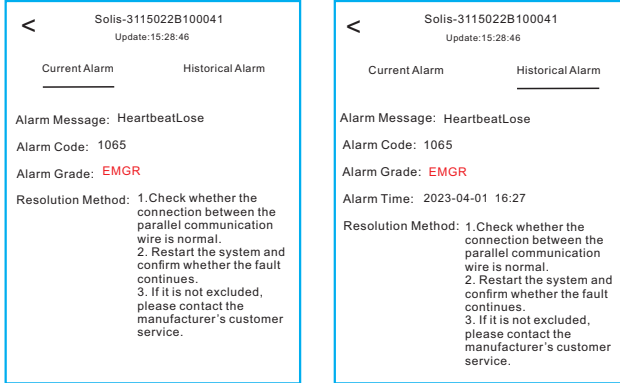

5.16.5 Settings

Mode Setting

The interface can display the current work mode, Self-Use/Feed in Priority/Off-Grid.

Battery Setting

Battery Model: select the battery model to be connected.

Peak-shaving setting: If the switch is enable, the power of force charging will be dynamically adjusted.

Few samples to be clear: (Forcecharge Limited Power Setting=4kW)

If the load=3kW,PV=0kW,P_forcecharge=P_Grid(4kW)-P_Load(3kW)=1kW.

If the load=10kW,PV=0kW,P_forcecharge=0kW,P_Grid=P_Load=10kW.

ECO Function: If PV power is lower than 100W and SOC falls below overdischarge SOC, the inverter will turn off the grid relays and IGBT switching. If forcecharge SOC is reached, it will connect back to grid and charge battery back to overdischarge SOC, then turn off again.

Battery wake up: After Battery wake up command, the inverter powers the DC battery port using Battery Wakeup Voltage and low AMP till BMS communication of battery will be restored and within awaken time.

Over-discharge SOC: When the battery is discharged to the over-discharge soc, the battery will nor discharge actively.(Due to the internal current, conduction, there is a small self-consumption power, if not charged for a long time, the SOC will slowly continue to decline.)

Force-charge SOC: Due to the battery power consumption, when the over-discharge SOC drops to the force-charge SOC, the inverter will directly charge the battery according to the maximum battery charging current until the battery SOC reaches the over-discharge SOC. (The charging power is not limited to sources, which may be from PV or from the grid. If “Charging from grid” is set to “Not Allow”, the charging logic may not be implemented.) It is not recommended to set the over-discharge & force-charge SOC to the same value, which may cause frequent charging and discharging.

GEN_Start_SOC/Volt: If SOC/Volt reaches GEN_Start_SOC/Volt, the generator can be started.

GEN_Exit_SOC/Volt: If SOC/Volt reaches GEN_Exit_SOC/Volt, the generator can be stopped.

Battery Setting	
Battery Model	PYLON_LV >
Peak-shaving Setting	<input type="checkbox"/>
Max. grid power when Forcecharging	500W >
Max. grid power when Forcecharging (Parallel)	0W >
ECO Function	<input type="checkbox"/>
Overdischarge SOC	20% >
Forcecharge SOC	10% >
Battery Overvoltage Protection Setting	60.0V >
Battery Undervoltage Protection Setting	42.0V >
GEN_Start_SOC	25% >
GEN_Exit_SOC	80% >
Battery Wake Up	>
Awaken Voltage	40.0V >
Awaken Time	20s >

Battery Setting	
Battery Model	Lead Acid >
Peak-shaving Setting	<input type="checkbox"/>
Max. grid power when Forcecharging	500W >
Max. grid power when Forcecharging (Parallel)	0W >
ECO Function	<input type="checkbox"/>
Battery Capacity	200Ah >
Max Charging Current	100.0A >
Max Discharging Current	100.0A >
Battery Overvoltage Protection Setting	60.0V >
Battery Undervoltage Protection Setting	42.0V >
Overdischarge Voltage	44.5V >
Force Voltage	43.8V >
GEN_Start_Volt	48.5V >
GEN_Exit_Volt	52.0V >
Equalization Voltage	56.4V >
Lead Acid TEMP CO	72mV/°C >
Environment temperature	Normal temper... >

The Grid power charging limit function under the battery reservation condition

When battery is set at a reserved SOC by the Reserved SOC setting, the Power from grid to charge battery is limited. If the Battery Peak shaving function is not enabled, user can also set Max grid power when Force charging. In this case, the Force charging power is charged according to the fixed value. The function can be enabled in Self-Use Mode and Feed in Priority Mode.

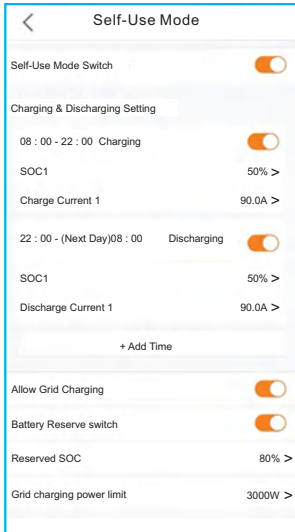

For Self-Use Mode

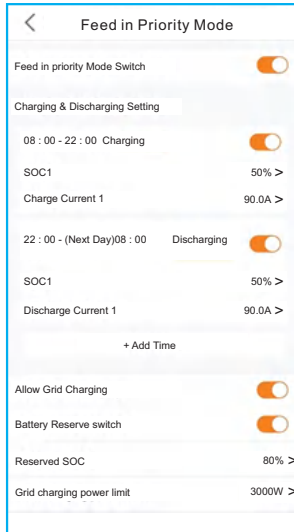

For Feed in Priority Mode

Battery Discharge Hysteresis SOC

When the Force-charge SOC is reached, the battery will be force-charged to the Overdischarge SOC + Overdischarge Hysteresis SOC. Overdischarge Hysteresis SOC range from 1% to 20%, Overdischarge Hysteresis SOC default value is 1%.

For example: If customer set the Overdischarge SOC is 20%, Overdischarge Hysteresis SOC is 5%. When the battery SOC is discharged to 10% (Forcecharge SOC set as 10%), Then the lithium SOC will be forcecharged to 25%.

Battery Healing function

When the lithium battery is kept at low SOC for a long time, the measurement of lithium battery SOC is not accurate. The Battery Healing function will allow the system to charge the battery to the set Battery Healing SOC when the battery reaches the discharged SOC, so as to ensure the healthy and stable operation of the lithium battery.

The Battery Equalization function of lead-acid battery

Pre-condition: When the days since last battery balancing exceed battery balancing Interval days already set. Then the inverter will not enter the floating charge mode when the lead-acid battery floating charge judgment is met for the first time on the same day when pre-condition occur. But force charge battery at a balanced voltage on a constant voltage state, the charging time is the time of balance, after finishing it, battery enter into float-charging state.

Battery Setting		Battery Setting	
Battery Type	Lithium Battery >	Battery Type	Lead-acid Battery >
Battery Model	Lithium Battery LV(RS485) >	Battery Capacity	200Ah >
Max Charging Current	190.0A >	Max Charging Current	50.0A >
Max Discharging Current	190.0A >	Max Discharging Current	50.0A >
Overdischarge SOC	20% >	Overdischarge Voltage	44.5V >
Overdischarge Hysteresis SOC	1% >	Forcecharge Voltage	43.8V >
Forcecharge SOC	10% >	Bulk Voltage	57.6V >
Battery Healing Switch	<input type="checkbox"/>	Float Voltage	54.0V >
Battery Healing SOC	100% >	Temperature compensation coefficient	0mV/°C >
Peak-shaving Setting	<input type="checkbox"/>	Battery Equalization	<input checked="" type="checkbox"/>
Max.grid power when Force charging	5000W >	Equalization Voltage	55.0V >
ECO Function	<input type="checkbox"/>	Equal Time	180min >
Battery Wakeup Switch	<input type="checkbox"/>	Equalized Interval	30day >
Auto Bat Awaken	<input type="checkbox"/>	Peak-shaving Setting	<input type="checkbox"/>
		Max.grid power when Force charging	1000W >
		ECO Function	<input type="checkbox"/>
		Battery Wakeup Switch	<input type="checkbox"/>
		Auto Bat Awaken	<input type="checkbox"/>

Meter/CT Setting

You can select meter or CT for system measurement.

Meter Type: Please select a correct type. The wrong option may cause the meter RS485 communication Failed. If the battery and meter are not connected, please select the “NO Meter” to shield the alarm of meter communication fault.

CT Reverse: If the direction is wrong, the sampling current of CT will be reversed when calculating the power.

CT Ratio: CT ratio is adjustable.

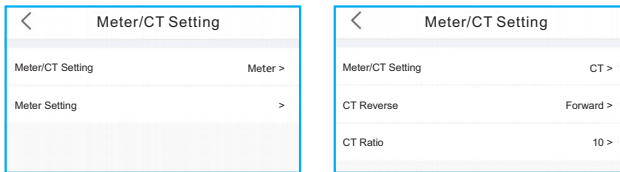

Grid Power Setting

System Export Power/Current: This is the amount of power/current the inverter is permitted to export(or sell) back to the utility company. If you do not want the system exporting power, this setting must be configured.

Failsafe Switch: Enabling the Failsafe switch will mean that the inverter will not produce any P power if the inverter loses communication with the meter.

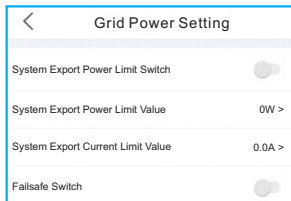

Backup Setting

Backup Voltage Setting: This is the voltage designated to the backup loads in the event of a grid power loss.

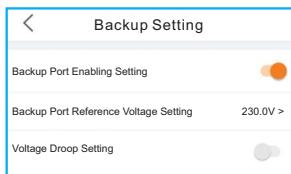

Generator Setting

With Generator: Please turn it on if the generator is ready to work.

GEN Power Setting: GEN Rated Power/GEN Max.Charge Power.

Generator Position: Grid Port/GEN Port.

Grid Port Powered By: If the generator is connected in Grid Port and the generator works , please select "Generator".

GEN Signal: If the generator can automatic start-stop,turn on the switch, once the generator start condition is reached,the inverter will start the generator automatically.

GEN Force: If $GEN_Start_SOC < SOC < GEN_Exit_SOC / GEN_Start_Volt < Volt < GEN_Exit_Volt$, the generator can be forced to start.

GEN Stop: If $GEN_Start_SOC < SOC < GEN_Exit_SOC / GEN_Start_Volt < Volt < GEN_Exit_Volt$, the generator can be forced to stop.

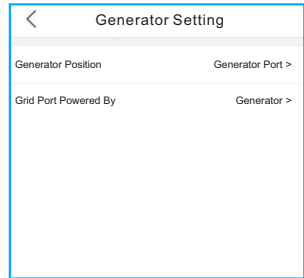
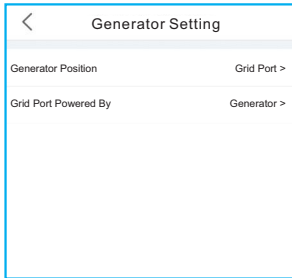
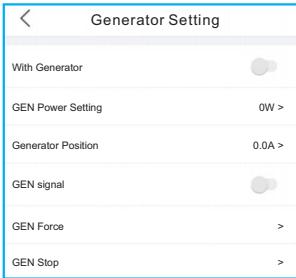

The Second backup load and smart load

Second backup load: The GEN port can be set as the second Backup port(The setting name on App: Gen Port Load Open), The Gen port has extended power, which can be used as a second Backup port to pick up loads when the generator is not connected, thus expanding backup capacity. In addition, in off-grid mode, the customer can remotely control, shut down this port, so that some non-essential loads stop running, while keeping the necessary loads, to achieve the purpose of energy saving.

Smart load: The smart load function means there is a load connected to GEN port can start or stop smartly. When the PV energy and battery SOC/Volt meet the set value, the relay at the generator port closes and outputs energy. When the PV energy is less than the set value or the battery SOC/Volt drops to OFF SOC/Volt, the relay disconnects and stops supplying power to the smart load.

Example: Set Start_Power=500W, Smart Load_ON_SOC=100%, Smart Load_OFF_SOC=95%. When $PV \geq 500W$ and SOC reaches 100%, Gen port supplies power to smart Load. If $PV < 500W$ or $SOC \leq 95\%$, the relay is disconnected and power supply is stopped.

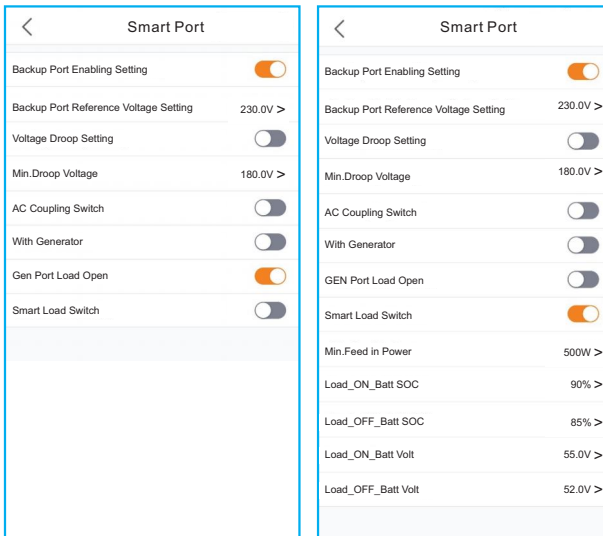

The start and stop signal control of generator

The setting GEN Signal on App is used for control the automatic start or automatic stop of generator .When the switch turned on, representing the generator possess the start and stop automatically function.

When the switch turned off, representing the generator don't have the start and stop automatically function. Customer need to start or stop it manually by other settings.

(Tips: this function only can be used for the generator with external communication interface)

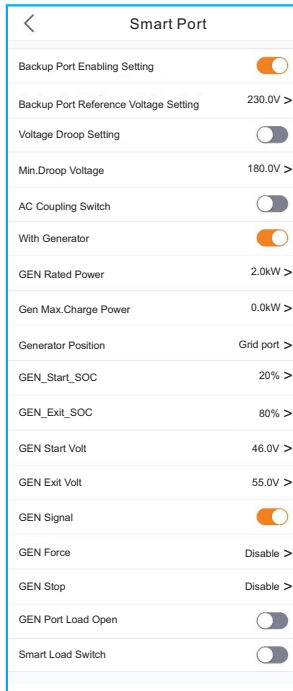

Parallel Setting

Parallel Mode: Single/Parallel

Address ID: 1 to 6

Manual Set Master/Slave: Address ID 1 is Master, the others is Slave.

Inverter Connected Phase Setting: Single Phase(single phase system)/
Phase A(Three Phase)/Phase B(Three Phase)/Phase C(Three Phase)

Total number of hybrid inverters connected: 0-6

Parallel Sync: The parameters of the master will be synchronized to the slaves, and some parameters of the slave cannot be set.

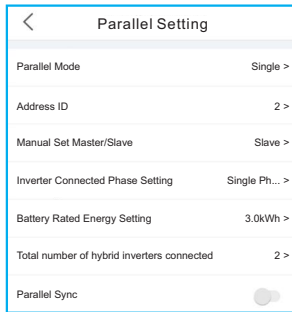

The inverter commissioning process has now been completed. It is recommended to monitor the system closely over the next week to ensure that everything is working as it should. Please refer to the Solis data logger manual for assistance with registering a new plant on SolisCloud.



NOTE:

A full factory reset can be done, if needed. This function can be found in the Special Setting Function menu within the Settings tab.

Solis S6 Series inverter does not require any regular maintenance. However, cleaning the heatsink will help the inverter dissipate heat and increase the lifetime of inverter. The dirt on the inverter can be cleaned with a soft brush.



CAUTION:

Do not touch the surface when the inverter is operating. Some parts may be hot and could cause burns. Turn OFF the inverter and let it cool down before you do any maintenance or cleaning of inverter.

The Screen and the LED status indicator lights can be cleaned with cloth if they are too dirty to be read.



NOTE:

Never use any solvents, abrasives, or corrosive materials to clean the inverter.

6.1 Smart O&M

In order to improve our products and provide you with higher quality services, this device has a built-in data logging module for collecting relevant information during operation (such as power generation data, fault data)

Commitment:

1. We will only collect, use and process your device information for the purpose of improving our products and services.
2. We will take all reasonable and feasible measures to ensure that no irrelevant information is collected and we will protect your device information.
3. We will not share, transfer or disclose the collected device information with any company, organization or individual.
4. When we stop operating products or services, we will stop collecting your device information in a timely manner.
5. If you do not want to provide such information, you can notify our company to turn off this function, which will not affect your normal use of other functions of the product.

7. Troubleshooting

Message Name	Information Description	Troubleshooting Suggestion
Off	Control device to shutdown	1. Turn on the device in the ON/OFF Setting.
LmtByEPM	The device's output is under controlled	<ol style="list-style-type: none"> 1. Confirm whether the inverter is connected to an external EPM/meter to prevent reverse current. 2. Confirm whether the inverter is controlled by an external third-party device. 3. Confirm whether the power setting of the inverter power control is limited. 4. Verify settings in section 6.6.7 and check your meter readings.
LmtByDRM	DRM Function ON	1. No need to deal with it.
LmtByTemp	Over temperature power limited	1. No need to deal with it, the device is in normal operation.
LmtByFreq	Frequency power limited	
LmtByVg	The device is in the Volt-Watt mode	<ol style="list-style-type: none"> 1. Due to the requirements of local safety regulations, when the grid voltage is high, the Volt-watt working mode is triggered, which generally does not need to be dealt with. 2. Inverter factory test errors causing this mode to open, if you need to close, you can close this mode in LCD, set the process: Main menu → Advanced Settings → Password 0010 → STD mode settings → Working Mode → Working mode: NULL → Save and exit.
LmtByVar	The device is in the Volt-Var mode of operation	<ol style="list-style-type: none"> 1. Due to the requirements of local safety regulations, when the grid voltage is high, the Volt-watt working mode is triggered, which generally does not need to be dealt with. 2. Inverter factory test errors causing this mode to open, if you need to close, you can close this mode in LCD, set the process: Main menu → Advanced Settings → Password 0010 → STD mode settings → Working Mode → Working mode: NULL → Save and exit.
LmtByUnFr	Under frequency limit	1. No need to deal with it.
Standby	Bypass run	
StandbySynoch	Off grid status to On grid status	
GridToLoad	Grid to load	

7. Troubleshooting

Message Name	Information Description	Troubleshooting Suggestion
Surge Alarm	On-site grid surge	1. Grid side fault, restart the device. If it is still not eliminated, please contact the manufacturer's customer service.
OV-G-V01	Grid voltage exceeds the upper voltage range	1. Confirm whether the power grid is abnormal. 2. Confirm that the AC cable is properly connected. 3. Restart the system and check if the fault persists.
UN-G-V01	Grid voltage exceeds the lower voltage range	
OV-G-F01	Grid frequency exceeds the upper frequency range	
UN-G-F01	Grid frequency exceeds the lower frequency range	
G-PHASE	Unbalanced grid voltage	
G-F-GLU	Grid voltage frequency fluctuation	
NO-Grid	No grid	
OV-G-V02	Grid transient overvoltage	
OV-G-V03	Grid transient overvoltage	1. Restart the system, confirm if that the fault continues.
IGFOL-F	Grid current tracking failure	1. Confirm whether the power grid is abnormal. 2. Confirm that the AC cable is properly connected. 3. Restart the system and check if the fault persists.
OV-G-V05	Grid voltage RMS instantaneous overvoltage fault	
OV-G-V04	Grid voltage exceeds the upper voltage range	
UN-G-V02	Grid voltage exceeds the lower voltage range	
OV-G-F02	Grid frequency exceeds the upper frequency range	
UN-G-F02	Grid frequency exceeds the lower frequency range	
NO-Battery	Battery is not connected	1. Check on information page 1 – Verify the battery voltage is within standards. 2. Measure battery voltage at plug.
OV-Vbackup	Inverting overvoltage	1. Check whether the backup port wiring is normal 2. Restart the system, confirm that the fault continues.
Over-Load	Load overload fault	1. Backup load power is too large, or some inductive load startup power is too large, need to remove some backup load, or remove the inductive load on the backup.

7. Troubleshooting

Message Name	Information Description	Troubleshooting Suggestion
BatName-FAIL	Wrong battery brand selection	1. Confirm whether the battery model selection is consistent with the actual one.
CAN Fail	CAN Fail	1. Can failure is a failure of communication between inverter and battery. Check cable conditions. Check to ensure you have it plugged in on the CAN port of the battery and inverter. Check that you are using the right cable. Some batteries require a special battery from the battery manufacturer.
OV-Vbatt	Battery undervoltage detected	1. Verify battery voltage is within standards. Measure battery voltage at inverter connection point. Contact your battery manufacturer for further service.
UN-Vbatt	Battery overvoltage detected	1. Restart the system and check if the fault persists. If it is still not eliminated, please contact the manufacturer's customer service.
Fan Alarm	Fan alarm	1. Check if the internal fan is working correctly or jammed.
OV-DC01 (1020 DATA:0001)	DC 1 input overvoltage	1. Check if the PV voltage is abnormal 2. Restart the system, confirm that the fault continues
OV-DC02 (1020 DATA:0002)	DC 2 input overvoltage	
OV-BUS (1021 DATA:0000)	DC bus overvoltage	1. Restart the system, confirm that the fault continues.
UN-BUS01 (1023 DATA:0001)	DC bus undervoltage	
UNB-BUS (1022 DATA:0000)	DC bus unbalanced voltage	
UN-BUS02 (1023 DATA:0002)	Abnormal detection of DC bus voltage	
DC-INTF. (1027 DATA:0000)	DC hardware overcurrent (1, 2, 3, 4)	1. Check if the DC wires are connected correctly without loose connection.
OV-G-I (1018 DATA:0000)	A phase RMS value overcurrent	1. Confirm that the grid is abnormal. 2. Confirm that the AC cable connection is not abnormal. 3. Restart the system, confirm that the fault continues.
OV-DCA-I (1025 DATA:0000)	DC 1 average overcurrent	1. Restart the system, confirm that the fault continues.
OV-DCB-I (1026 DATA:0000)	DC 2 average overcurrent	
GRID-INTF. (1030 DATA:0000)	AC hardware overcurrent (abc phase)	

Message Name	Information Description	Troubleshooting Suggestion
DCInj-FAULT (1037 DATA:0000)	The current DC component exceeds the limit	<ol style="list-style-type: none"> 1. Confirm that the grid is abnormal. 2. Confirm that the AC cable connection is not abnormal. 3. Restart the system, confirm that the fault continues.
IGBT-OV-I (1048 DATA:0000)	IGBT overcurrent	<ol style="list-style-type: none"> 1. Restart the system, confirm that the fault continues.
OV-TEM (1032 DATA:0000)	Module over temperature	<ol style="list-style-type: none"> 1. Check whether the surrounding environment of the inverter has poor heat dissipation. 2. Confirm whether the product installation meets the requirements.
RelayChk-FAIL (1035 DATA:0000)	Relay failure	<ol style="list-style-type: none"> 1. Restart the system, confirm that the fault continues.
UN-TEM (103A DATA:0000)	Low temperature protection	<ol style="list-style-type: none"> 1. Check the working environment temperature of the inverter. 2. Restart the system to confirm if the fault continues.
PV ISO-PRO01 (1033 DATA:0001)	PV negative ground fault	<ol style="list-style-type: none"> 1. Check whether the PV strings have insulation problems. 2. Check whether the PV cable is damaged.
PV ISO-PRO02 (1033 DATA:0002)	PV positive ground fault	
12Power-FAULT (1038 DATA:0000)	12V undervoltage failure	<ol style="list-style-type: none"> 1. Check current leakage to ground. Verify your grounding. Verify all wires are in good condition and not leaking current to ground.
ILeak-PRO01 (1034 DATA:0001)	Leakage current failure 01 (30mA)	
ILeak-PRO02 (1034 DATA:0002)	Leakage current failure 02 (60mA)	
ILeak-PRO03 (1034 DATA:0003)	Leakage current failure 03 (150mA)	
ILeak-PRO04 (1034 DATA:0004)	Leakage current failure 04	
ILeak_Check (1039 DATA:0000)	Leakage current sensor failure	
GRID-INTF02 (1046 DATA:0000)	Power grid disturbance 02	<ol style="list-style-type: none"> 1. Confirm whether the grid is seriously distorted. 2. Check whether the AC cable is connected reliably.
OV-Vbatt-H/ OV-BUS-H (1051 DATA:0000)	Battery overvoltage hardware failure / VBUS	<ol style="list-style-type: none"> 1. Check if the battery circuit breaker is tripping. 2. Check if the battery is damaged.

Message Name	Information Description	Troubleshooting Suggestion
OV-ILLC (1052 DATA:0000)	LLC hardware overcurrent	1. Check whether the backup load is overloaded. 2. Restart the system, confirm that the fault continues.
INI-FAULT (1031 DATA:0000)	AD zero drift overlink	1. Restart the system, confirm that the fault continues.
DSP-B-FAULT (1036 DATA:0000)	The master-slave DSP communication is abnormal	
AFCI-Check (1040 DATA:0000)	AFCI self-test failure	
ARC- FAULT (1041 DATA:0000)	AFCI failure	1. Verify connections are tight within your PV system. Arc fault settings can be changed in advanced settings if further adjustment is necessary.

Table 7.1 Fault message and description



NOTE:

If the inverter displays any alarm message as listed in Table 7.1; please turn off the inverter and wait for 5 minutes before restarting it .
If the failure persists, please contact your local distributor or the service center.

Please keep ready with you the following information before contacting us.

1. Serial number of Solis Singles Phase Inverter;
2. The distributor/dealer of Solis Singles Phase Inverter (if available);
3. Installation date.
4. The description of the problem together with necessary information, pictures, attachment.
5. The PV array configuration (e.g. number of panels, capacity of panels, number of strings, etc.);
6. Your contact details.

8. Specifications

Technical Data	S6-EH3P8K02-NV-YD-L	S6-EH3P10K02-NV-YD-L
Input DC (PV side)		
Max Usable PV Input Power	12.8kW	16kW
Max. input voltage	1000V	
Rated voltage	550V	
Start-up voltage	160V	
MPPT voltage range	200-850V	
Full load MPPT voltage range	213-850V	266-850V
Max. input current	20A/40A	
Max. short circuit current	30A/50A	
MPPT number/Max input strings number	2/3	
Battery		
Battery Type	Li-ion/Lead-acid	
Battery Voltage range	40-60V	
Max. charge / discharge current	180A	220A
Communication	CAN/RS485	
Output AC(Grid side)		
Rated output power	8kW	10kW
Max. apparent output power	8kVA	10kVA
Rated grid voltage	3/N/PE, 220V/380V 3/N/PE, 230V/400V	
The grid voltage range	323-460V	
Rated grid frequency	50Hz/60Hz	
AC grid frequency range	45-55Hz/55-65Hz	
Rated grid output current	12.2A/11.5A	15.2A/14.4A
Max. output current	12.2A/11.5A	15.2A/14.4A
Power Factor	> 0.99 (0.8 leading - 0.8 lagging)	
THDi	<3%	

8. Specifications

Technical Data	S6-EH3P8K02-NV-YD-L	S6-EH3P10K02-NV-YD-L
Input AC (Grid side)		
Max. input power	12kW	15kW
Input voltage range	323-460V	
Max. input current	18.3A/17.3A	22.8A/21.7A
Rated input frequency	45-55Hz/55-65Hz	
Input AC (Generator)		
Max. input power	8kW	10kW
Max. input current	12.2A	15.2A
Rated input voltage	3/N/PE, 220V/380V 3/N/PE, 230V/400V	
Rated input frequency	50Hz/60Hz	
Output AC(Back-up)		
Rated output power	8kW	10kW
Max. apparent output power	2 times of rated power, 10 S	
Back-up switch time	<10ms	
Rated output voltage	3/N/PE, 220V/380V 3/N/PE, 230V/400V	
Rated frequency	50 Hz/60 Hz	
Rated output current	12.2A/11.5A	15.2A/14.4A
Max. Continuous output current	12.2A	15.2A
Max. Continuous AC Passthrough current	50A	
Max. allowable phase imbalance	50%	
THDv(@linear load)	<3%	
Efficiency		
Max. efficiency	97.5%	
EU efficiency	97.0%	
BAT charged by PV Max. efficiency	95.0%/94.4%	
BAT charged/discharged to AC Max. efficiency	94.5%	
MPPT Efficiency	99.9%	

8. Specifications

Technical Data	S6-EH3P8K02-NV-YD-L	S6-EH3P10K02-NV-YD-L
Protection		
Anti-islanding protection	Yes	
Insulation Resistor detection	Yes	
Output over current protection	Yes	
Output short protection	Yes	
Output over voltage protection	Yes	
DC reverse polarity protection	Yes	
DC surge protection/AC surge protection	Yes	
General data		
Dimensions(W/H/D)	430*660*305mm	
Weight	≤42KG	
Topology	Non-isolated	
Self consumption (Night)	<30W	
Operation temperature range	-40°C ~ +60°C	
Relative humidity	0-95%	
Ingress protection	IP66	
Noise emission	<65 dB(A)	
Cooling concept	Smart Fan Cooling	
Max.operation altitude	4000m	
Grid connection standard	NRS 097-2-1, IEC 62116, IEC 61727, IEC 60068, IEC 61683, EN 50530, SriLanka, EN 50438L, Vietnam, MEA, PEA	
Safety/EMC standard	IEC/EN 62109-1/-2, IEC/EN 61000-6-1/-3	
Features		
PV connection	MC4 Quick connection plug(PV)& Screw terminal(Battery)	
AC connection	Screw terminal	
Display	LCD + Bluetooth + APP	
Communication	CAN, RS485, Ethernet, Optional:Wi-Fi, Cellular, LAN	
Warranty	5 years (Extend to 20 years)	

8. Specifications

Technical Data	S6-EH3P12K02-NV-YD-L	S6-EH3P15K02-NV-YD-L
Input DC (PV side)		
Max Usable PV Input Power	19.2kW	24kW
Max. input voltage	1000V	
Rated voltage	550V	
Start-up voltage	160V	
MPPT voltage range	200-850V	
Full load MPPT voltage range	320-850V	300-850V
Max. input current	20A/40A	40A/40A
Max. short circuit current	30A/50A	50A/50A
MPPT number/Max input strings number	2/3	2/4
Battery		
Battery Type	Li-ion/Lead-acid	
Battery Voltage range	40-60V	
Max. charge / discharge current	250A	290A
Communication	CAN/RS485	
Output AC(Grid side)		
Rated output power	12kW	15kW
Max. apparent output power	12kVA	15kVA
Rated grid voltage	3/N/PE, 220V/380V 3/N/PE, 230V/400V	
The grid voltage range	323-460V	
Rated grid frequency	50Hz/60Hz	
AC grid frequency range	45-55Hz/55-65Hz	
Rated grid output current	18.2A/17.3A	22.8A/21.7A
Max. output current	18.2A/17.3A	22.8A/21.7A
Power Factor	> 0.99 (0.8 leading - 0.8 lagging)	
THDi	<3%	

8. Specifications

Technical Data	S6-EH3P12K02-NV-YD-L	S6-EH3P15K02-NV-YD-L
Input AC (Grid side)		
Max. input power	18kW	22.5kW
Input voltage range	323-460V	
Max. input power	27.3A/26.0A	34.2A/32.5A
Rated input frequency	45-55Hz/55-65Hz	
Input AC (Generator)		
Max. input power	12kW	15kW
Max. input current	18.2A	22.8A
Rated input voltage	3/N/PE, 220V/380V 3/N/PE, 230V/400V	
Rated input frequency	50Hz/60Hz	
Output AC(Back-up)		
Rated output power	12kW	15kW
Max. apparent output power	2 times of rated power, 10 S	
Back-up switch time	<10ms	
Rated output voltage	3/N/PE, 220V/380V 3/N/PE, 230V/400V	
Rated frequency	50 Hz/60 Hz	
Rated output current	18.2A/17.3A	22.8A/21.7A
Max. Continuous output current	18.2A	22.8A
Max. Continuous AC Passthrough current	50A	
Max. allowable phase imbalance	50%	
THDv(@linear load)	<3%	
Efficiency		
Max. efficiency	97.5%	
EU efficiency	97.0%	
BAT charged by PV Max. efficiency	95.0%/94.4%	
BAT charged/discharged to AC Max. efficiency	94.5%	
MPPT Efficiency	99.9%	

8. Specifications

Technical Data	S6-EH3P12K02-NV-YD-L	S6-EH3P15K02-NV-YD-L
Protection		
Anti-islanding protection	Yes	
Insulation Resistor detection	Yes	
Output over current protection	Yes	
Output short protection	Yes	
Output over voltage protection	Yes	
DC reverse polarity protection	Yes	
DC surge protection/AC surge protection	Yes	
General data		
Dimensions(W/H/D)	430*660*305mm	
Weight	≤42KG	
Topology	Non-isolated	
Self consumption (Night)	<30W	
Operation temperature range	-40°C ~ +60°C	
Relative humidity	0-95%	
Ingress protection	IP66	
Noise emission	<65 dB(A)	
Cooling concept	Smart Fan Cooling	
Max.operation altitude	4000m	
Grid connection standard	NRS 097-2-1, IEC 62116, IEC 61727, IEC 60068, IEC 61683, EN 50530, SriLanka, EN 50438L, Vietnam, MEA, PEA	
Safety/EMC standard	IEC/EN 62109-1/-2, IEC/EN 61000-6-1/-3	
Features		
PV connection	MC4 Quick connection plug(PV)& Screw terminal(Battery)	
AC connection	Screw terminal	
Display	LCD + Bluetooth + APP	
Communication	CAN, RS485, Ethernet, Optional:Wi-Fi, Cellular, LAN	
Warranty	5 years (Extend to 20 years)	

Frequently Asked Questions

Q1: Why I have "CAN Fail" Alarm on the inverter?

A: "CAN Fail" indicates the CAN communication between inverter and battery is lost. Please double check if your CAN cable is correctly connected and if your battery is power on.

Q2: Why I have "BATName-Fail" Alarm on the inverter ?

A: Please check in the "Battery Setting->Battery Model" setting and confirm you selected the correct battery option as the nameplate of your battery module.

Q3: Why I have "MET-SLT-Fail" Alarm on the inverter?

A: Please check in the "Meter Setting->Meter Type" setting and confirm you selected the correct meter option corresponding to your smart meter.

Q4: Why the power values on the screen are fluctuating very fast?

A: If your loads are changing drastically, the inverter will adjust its power accordingly. If you confirm the loads are stable while the inverter power is changing very fast, please double check your meter CT's direction and make sure the arrow is towards grid.

Q5: Why I have "OV-ILLC" Alarm on the inverter ?

A: OV-ILLC indicates there is an overcurrent issue on the internal LLC circuit. It could be transient status during extreme condition such as overload. If it happens constantly or too frequent and the extreme conditions have been excluded, please contact Solis service team.

Q6: Why I have "OV-BATT-H" Alarm on the inverter ?

A: OV-BATT-H indicates over voltage issue on the hardware of battery circuit. It could be caused by high battery voltage at full SOC, battery suddenly switching off, etc. If it happens constantly or too frequent and the extreme conditions have been excluded, please contact Solis service team.

Q7: Why I have "No-Battery" Alarm on the inverter?

A: Please double check if the battery power cables have been correctly connected and the battery breaker (on battery or external) has been turn on. If you don't want to connect the battery for now, please select the "No battery" option in "Battery Setting->Battery Model" to prevent the alarm to show up.

Ginlong Technologies Co., Ltd.

No. 57 Jintong Road, Binhai Industrial Park, Xiangshan, Ningbo,
Zhejiang, 315712, P.R.China.

Tel: +86 (0)574 6578 1806

Email: info@ginlong.com

Web: www.solisinverters.com

Please adhere to the actual products in case of any discrepancies in this user manual.

If you encounter any problem on the inverter, please find out the inverter S/N and contact us, we will try to respond to your question ASAP.