

SOLUXTEC

made in Germany.

USER GUIDE

SOLUXTEC SOLAR
PRODUCTS



1. INTRODUCTION	3
2. BASIC SAFETY INSTRUCTIONS	3
3. REGULATION	4
4. TRANSPORT AND HANDLING	4
5. PRODUCT DETAILS	5
6. INSTALLATION	6
Modules Design	6
Precaution	13
Installation Option	15
7. ELECTRICAL INSTALLATION	13
Precaution	18
Wiring	18
8. MAINTENANCE AND CLEANING	22

1 INTRODUCTION

Thank you for electing SOLUXTEC GmbH PV modules. The following user guide is covering important points to be read and understood before installation of SOLUXTEC products. This document is not having any aims in relation to quality warranties but only for safety, electrical, mechanical and general handling of SOLUXTEC products.

In case a pv installation is not respecting above mentioned points, the quality warranty of SOLUXTEC product will become invalid.

This document belongs to SOLUXTEC, all contents are SOLUXTEC intellectual properties. SOLUXTEC reserves the right to modify this document without prior notice.

- Please read this document carefully before installation
- Please make sure that this document is always available for installers and operators to handle SOLUXTEC's products.
- Please give a copy of this document to the installation owner.
- If any questions are not well answered in this document, please contact SOLUXTEC support prior installation.

2 SAFETY

- ⚠ The installation of photovoltaic modules must respect the current standards from the place of installation. It is imperative to refer to the standards of each local authority in case specific rules are imposed.
- ⚠ Installation of photovoltaic modules must be operated by qualified people, knowing and respecting all regulation and requirements for compliance with country of installation.
- ⚠ Solar modules create DC electricity and are even energized under a slight illumination level. Several modules connected together may occur an accumulation of voltage and intensity. Please respect all personal security to avoid a risk of electrocution.
- ⚠ Please respect the data given from the elected module's data sheet to respect all module's limits and comply with other materials that will be needed to operate the photovoltaic generator.
- ⚠
 - Never open the junction box on the back of the photovoltaic module
 - Make sure that connectors are clean and not dirty or wet before connection.
 - Never disconnect the photovoltaic connector under load. Always turn off the DC breaker prior any photovoltaic connector disconnection.
 - Tools must be dedicated for solar installation and supporting DC current.
 - The final photovoltaic generator must follow all needed standard and requirement in compliance with the installation country (PV, inverter, cable, grounding and other accessories from the pv generator).
 - Never disassembled any part of the module.

3 REGULATION











All modules presented in this document are covered from the following standards:

- IEC 61215
- IEC 61730
- IEC 62804 (PID)
- IEC 61701 (SALT MIST)
- IEC 62716 (AMMONIA)
- EMC and Low Voltage regulation

NOTE: As SOLUXTEC is always improving his products. Please contact your customer service if a standard is missing for your project from above list.

4 TRANSPORT AND HANDLING

During transportation and Interim storage, following point have to be respected:

-  Transportation of the modules need to be done only with SOLUXTEC original packaging.
-  Never exceed the maximum number of pallets to be stacked. Only original SOLUXTEC packaging may allow pallet stacking.
-  When unpacking modules from the packaging, please wear soft and clean gloves. It is forbidden to use suction cup to carry the module as it will damage the anti-reflective coating for the solar glass.
-  It is forbidden to carry/lift the modules from the solar cables or from the junction box or any conductive elements.
-  Do not drop module directly on module.
-  By handling modules be cautious especially on the corners to not shock them.
-  By handling the modules, never scratch the anodised coating of the frame. Corrosion may occur and brings to a mechanical resistance diminution.
-  It is forbidden to drill holes in the aluminium frames.
-  It is forbidden to paint the modules or to apply any adhesive on the module's surface.
-  Never walk on the module.

5 PRODUCTS DETAILS

This document is valid for all products above:

	cell type	availability	reference	Type		Variante	colours
Das modul Mono XSC	Perc M10	until 2023	DMMXSC	glass foil	framed	Anti Glare / AC	black, white
Das modul Mono XSC Pure Glass	Perc M10	until 2023	DMMXSC_PG	glass glass Bifacial	framed	AC	black, transparent
PowerSlate Mono XSC	Perc M10	until 2023	PSMXSC	glass foil	frameless	na	black
Das Modul Mono XSC Ninside	Ntype M10	from 2023	DMMXSCNi	glass foil	framed	Anti Glare / AC	black, white
Das Modul Mono XSC Ninside Pure Glass	Ntype M10	from 2023	DMMXSCNi_PG	glass glass Bifacial	framed	AC	black, transparent
PowerSlate Mono XSC Ninside	Ntype M10	from 2023	PSMXSCNi	glass foil	frameless	na	black
Das Modul Mono Alpine XSC Ninside	Ntype M10	from 2023	DMMAXSCNi	glass foil	framed	AC	black, white
Das Modul Mono Alpine XSC Ninside Pure Glass	Ntype M10	from 2023	DMMAXSCNi_PG	glass glass Bifacial	framed	AC	black, transparent
PowerSlate Mono Alpine XSC Ninside Pure Glass	Ntype M10	from 2023	PSMAXSCNi_PG	glass glass Bifacial	frameless	na	transparent

Label explanation:



All Module Type from SOLUXTEC is having his own label on back.

This label is summarizing the module data sheet as follow:

- Place of production
- Commercial name
- STC (standard test condition) data:
 - Pmpp : Power in watt at maximum power point
 - Isc : Short circuit Intensity in ampere
 - Impp : Intensity in ampere at power point
 - Voc : Voltage in volt in open circuit
 - Vmpp : Voltage in volt at power point
 - EAN 13 code

For more details about mechanical or electrical module behaviour, please refer to dedicated data sheet.

Serial number codification:

S T U V WW XX YYY ZZZZ, where:

- | | | | |
|-------|--|-------|--|
| - S = | D for DAS MODUL
P for POWERSLATE | - V = | 1 for production in Foehren
Robert Schumann 4, 54343 (DE)
2 for production in Bitburg
Werner von siemens 25, 54634 (DE) |
| - T = | F for foil module 108 cells
G for glass glass module 108 cells
H for foil Module 90 cells
I for glass glass module 90 cells
J for foil module Anti-glare 108 cells | - W = | month of production |
| - U = | I Perc Half cut mono M10
N Half cut mono Topcon M10 | - X = | year of production |
| | | - Y = | Production order number |
| | | - Z = | Module number from above Production
Order number. |

6 INSTALLATIONS ON SITE

SOLUXTEC pv modules installation need to respect the following guidelines on site.

MODULE DESIGN PRESENTATION

a) DAS MODUL MONO XSC (DMMXSC)

Mono perc M10 half cut (all values are given in mm)

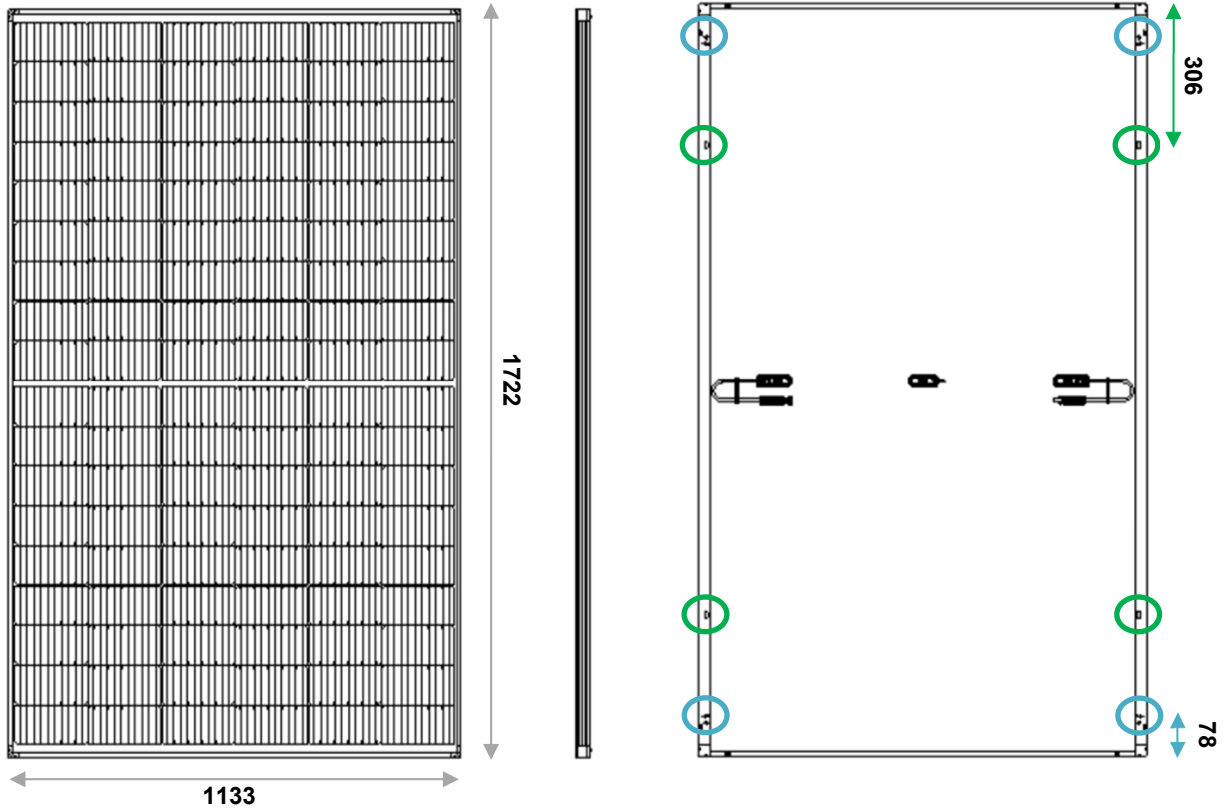

Frame section (double section):

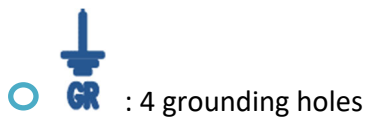
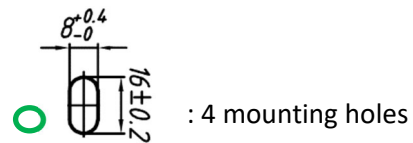
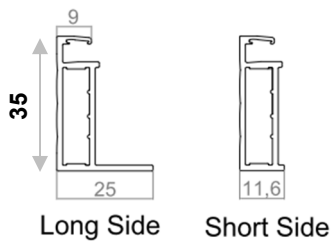

Maximum load test: + 5400 Pa // - 2400 Pa

b) DAS MODUL MONO XSC Ni (DMMXSCNi)

Mono ntype M10 half cut TOPCON (all values are given in mm)

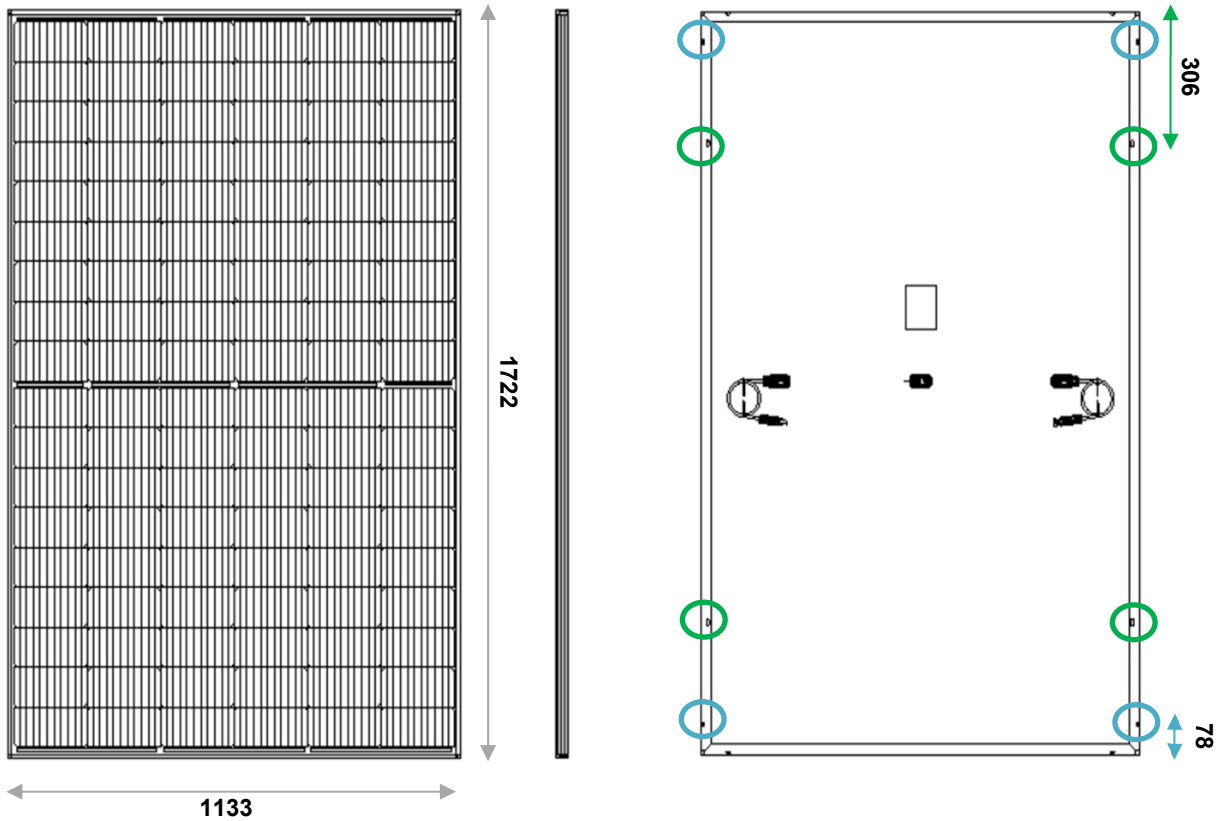

Frame section:

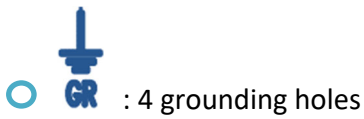
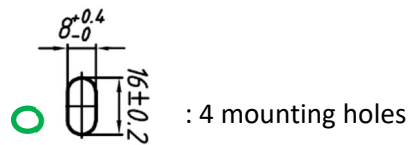
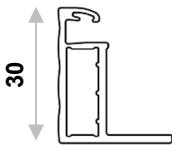

Maximum load test: + 5400 Pa // - 2400 Pa



New cells Ntype Topcon
 New Frame with stronger alloy
 New plastic corner unbreakable

c) DAS MODUL MONO XSC Ni Pure Glass (DMMXSCNi_PG)

Mono ntype M10 half cut TOPCON GLASS GLASS (all values are given in mm)

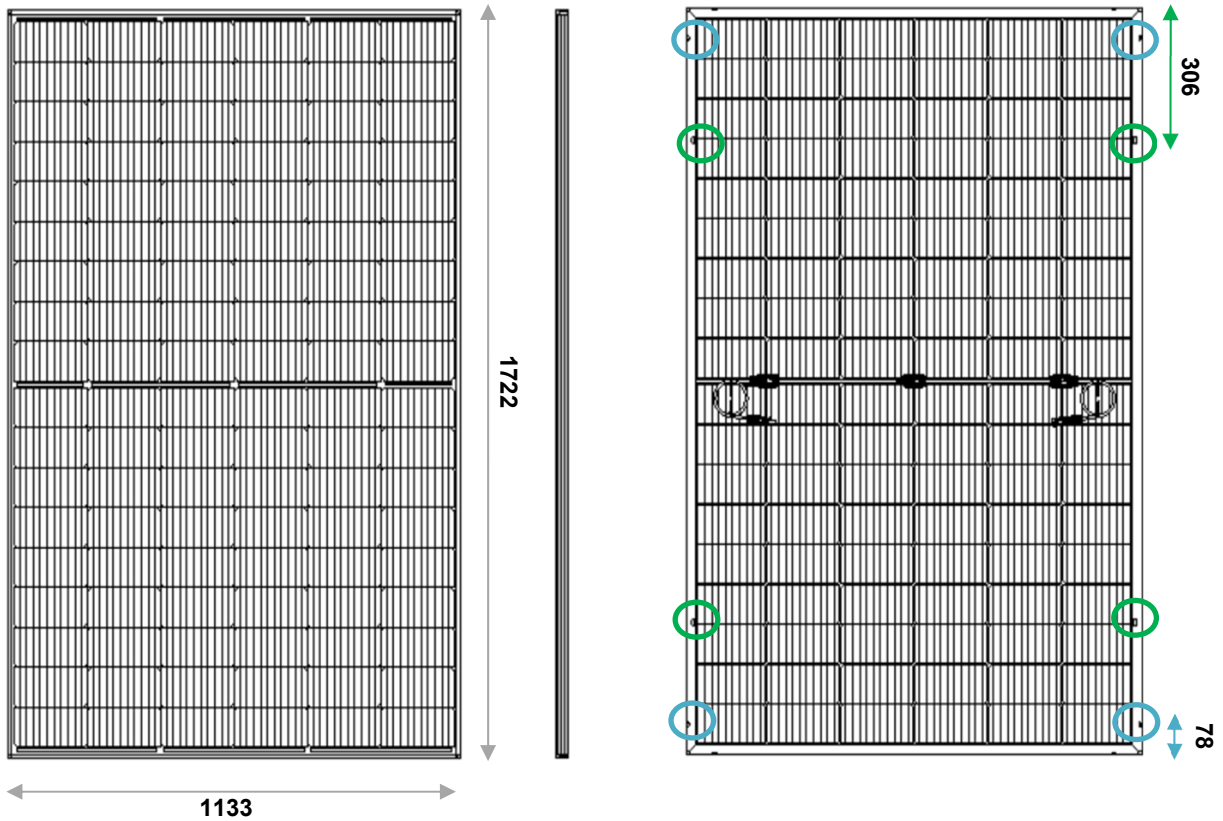

Frame section:

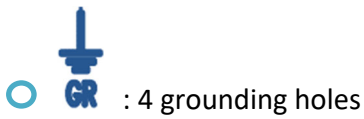
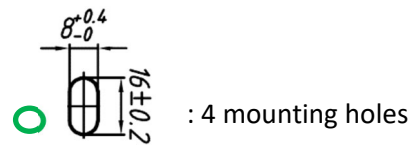
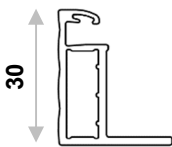

Maximum load test: + 8100 Pa // - 3000 Pa



New cells Ntype Topcon
 New Frame with stronger alloy
 New plastic corner unbreakable
 Bifaciality 0,8

d) DAS MODUL MONO Alpine XSC Ni (DMMAXSCNi)

Mono ntype M10 half cut TOPCON 90 cells (all values are given in mm)

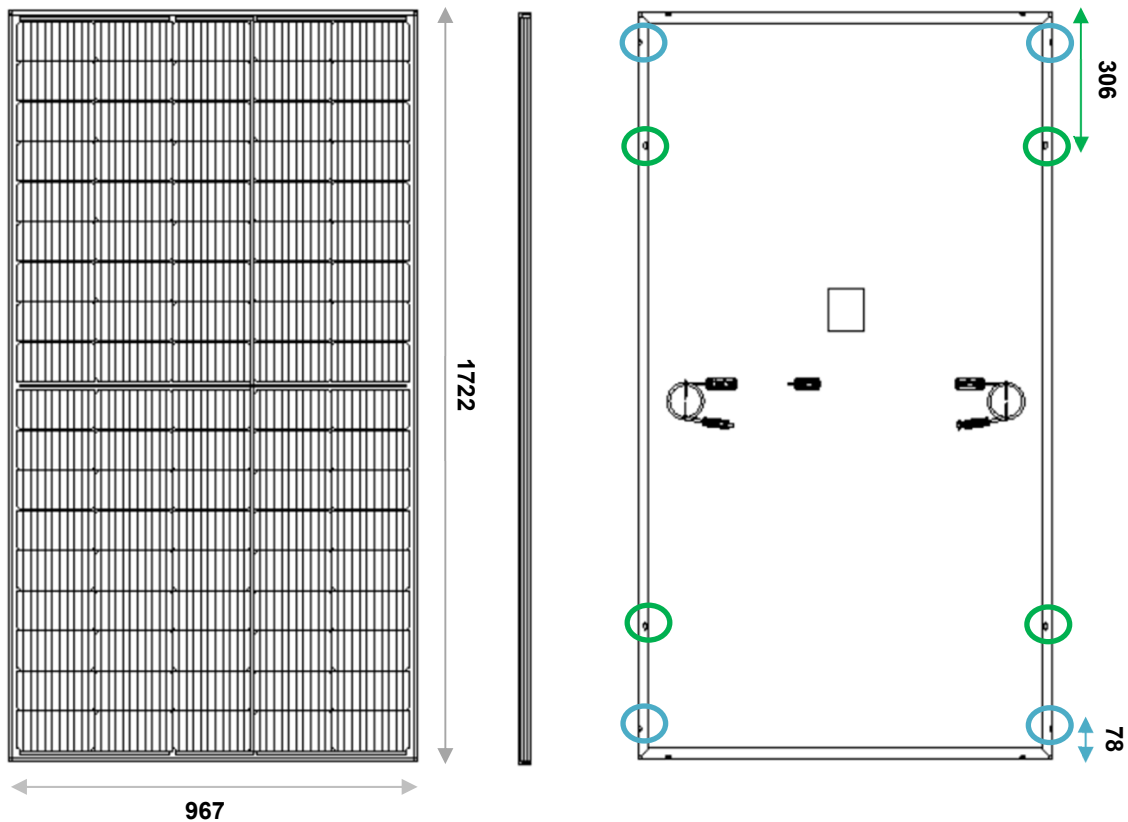

Frame section:

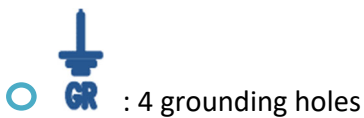
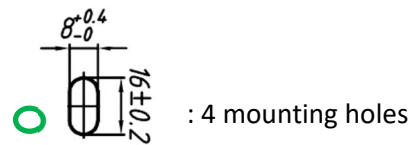
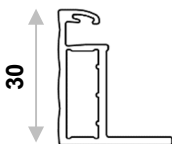

Maximum load test: + 5400 Pa // - 2400 Pa



New cells Ntype Topcon
 New Frame with stronger alloy
 New plastic corner unbreakable
 Easy to carry

e) DAS MODUL MONO Alpine XSC Ni Pure Glass (DMMAXSCNi_PG)

Mono ntype M10 half cut TOPCON 90 cells GLASS GLASS (all values are given in mm)

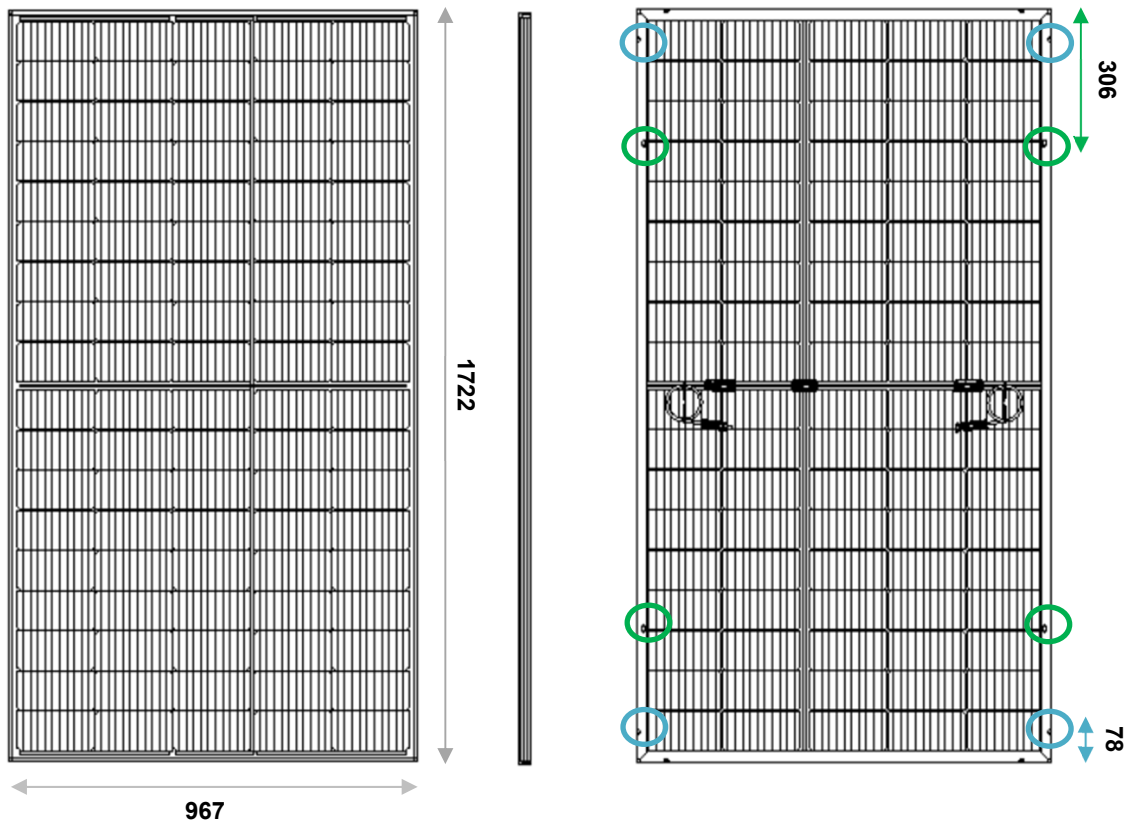

Frame section:

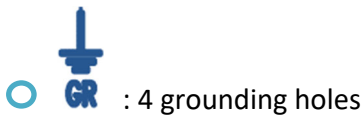
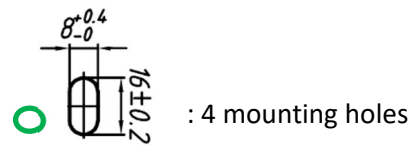
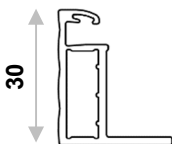

Maximum load test: + 8100 Pa // - 2400 Pa



New cells Ntype Topcon
 New Frame with stronger alloy
 New plastic corner unbreakable
 Bifaciality 0,8
 Easy to carry

f) PowerSlate MONO XSC Ni (PSMXSCNi)

Mono ntype M10 half cut TOPCON 108 cells frameless *(all values are given in mm)*

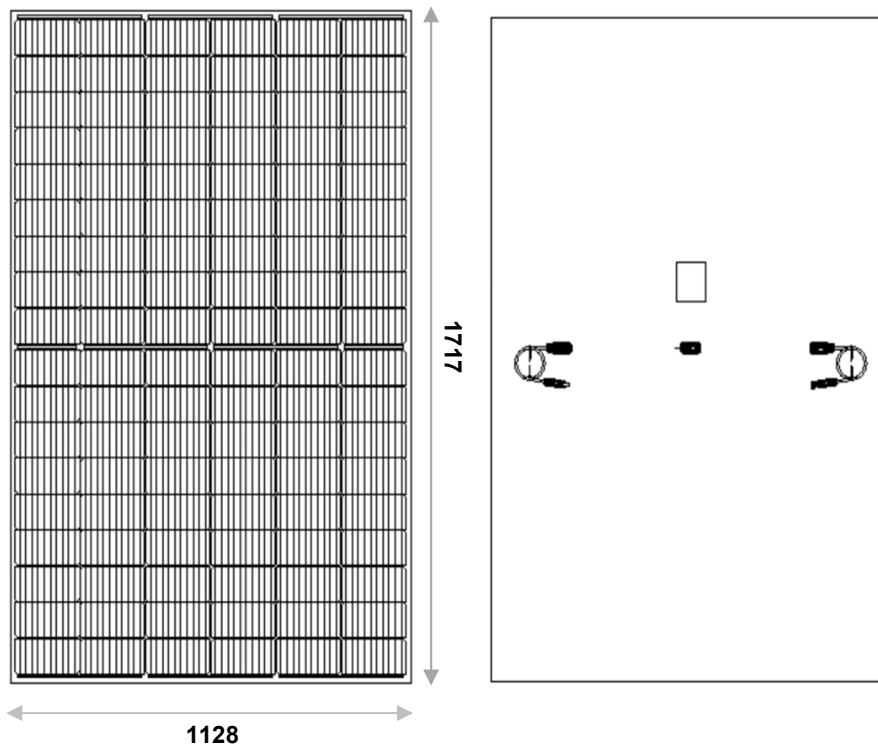

Maximum load test: + 2400 Pa // - 2400 Pa

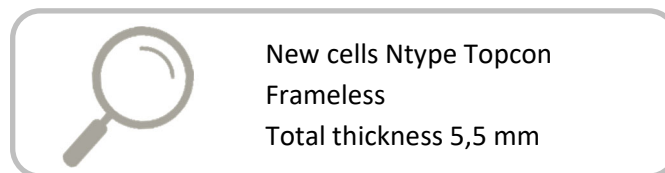

g) PowerSlate MONO Alpine XSC Ni PG (PSMAXSCNi_PG)

Mono ntype M10 half cut TOPCON 90 cells frameless Glass/Glass *(all values are given in mm)*

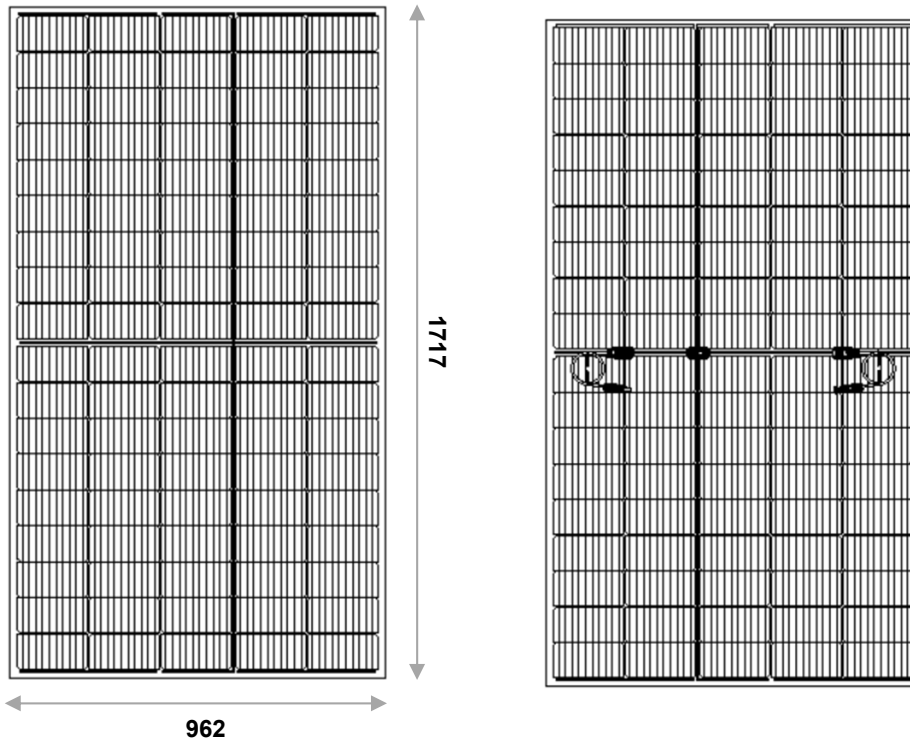

Maximum load test: + 3600 Pa // - 2400 Pa



New cells Ntype Topcon
Frameless 3,2 / 2
Total thickness 6,5 mm
Bifaciality 0,8

PRECAUTION:

- Operate Solar Pv modules in a safe environment. Suitable and exempt of any risks.
- Maximum height to operate the modules is 4000 m above the sea level
- Please do not use any abrasive or chemical solution on the modules. Neither on glass nor on aluminium frames.
- Avoid to bring module in direct contact with salt water.
- Solar pv modules are not to be considered as a roofing substitute. Solar Pv modules alone can't grant any roof waterproofing. Roof waterproofing can be obtain considering the addition of a PV module and a BIPV* solution.
**building integrated photovoltaic.*
- Operating Temperature from -40°C to 85°C.

- The best efficiency will be obtained by optimising the angle of inclination and facing the Sun.
- When electing final position of the pv modules it is recommended to avoid any potential shadowing that could result from building, chimney, trees and so on... Shadowing could result in to a significant energy loss.

- SOLUXTEC's pv modules can be installed only with mounting structures.
- Mounting structures need to comply with any applicable law requested from the country of installation.
- Modules need to be installed on mounting structure following producer user guide.
- Respect a sufficient ventilation of the pv modules.
- Respect mounting structure dilatation to avoid any extra mechanical stress on pv modules
- Make sure to use a mounting structure material that won't present any chemical reaction on pv module frame material (corrosion phenomena)

- Clamp's election is important and need to full fill those minimum standards:

Modules should be mounted using dedicated clamps specifically designed for solar modules, as illustrated on the right picture. It is advisable to utilize metal clamps with a minimum length of 50 mm for both end or middle clamps. The chosen clamps' alloy should possess sufficient strength to withstand snow load and wind conditions in line with the installation environment.

As a general guideline,

we recommend a minimum clamp thickness of 3 mm. Ensure that the clamps do not come into direct contact with the glass of the photovoltaic module and do not create any shadowing effects on the solar cells. Bolt tightening force between 18Nm to 20Nm.

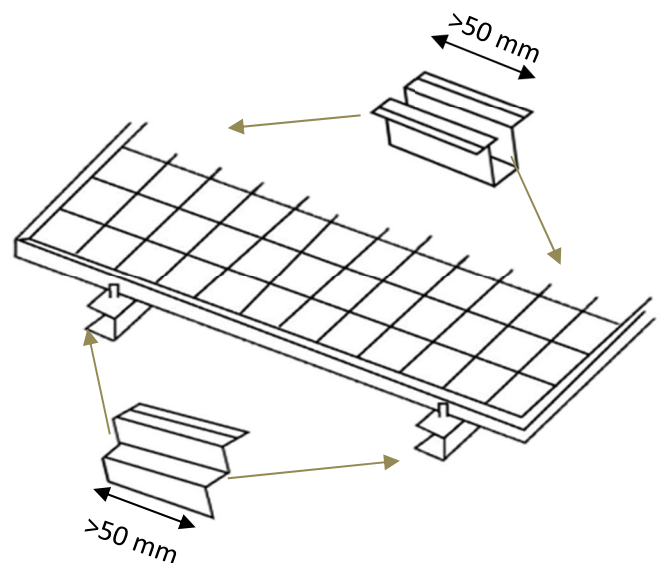

- Frameless module clamps need an EPDM protection to tight on glass.

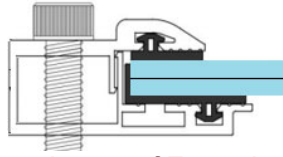

For each type of Frameless modules, a minimal length of 120 mm is mandatory.



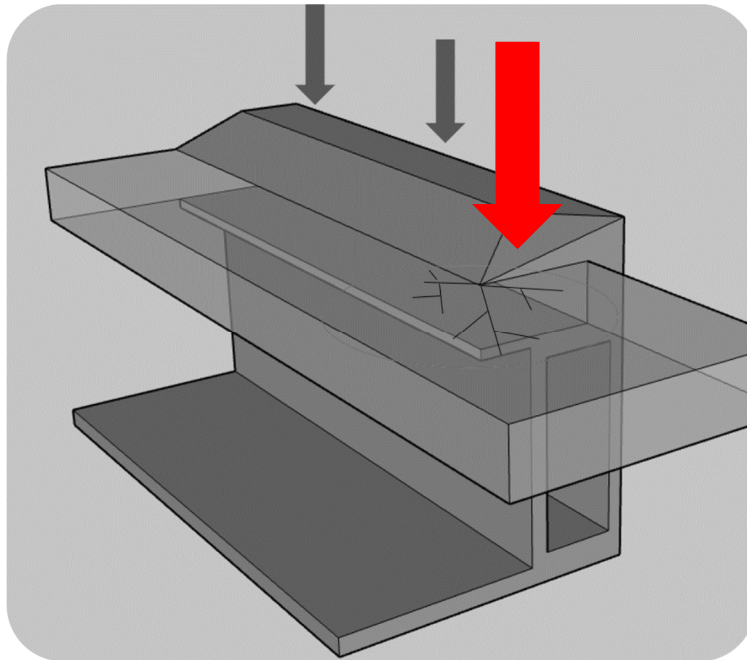

- When tightened, it is forbidden that clamps shown a module frame deformation.





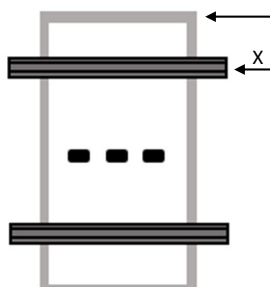
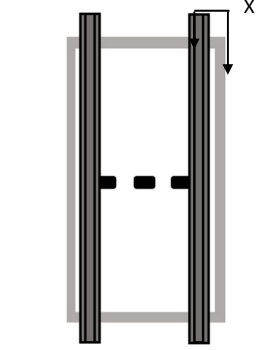

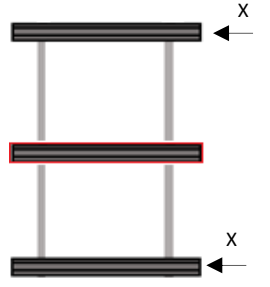

When clamping, please make sure that force is homogenous shared on aluminium part. Forced cannot deform top frame flange. For modules series equipped with a water drain corner, clamp must not be applied directly on.

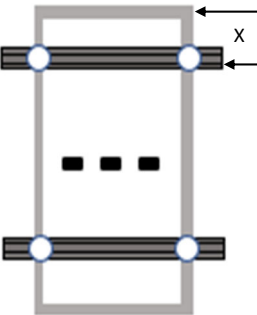
- ➔ Please refer to table on next page showing the different installation option from SOLUXTEC's modules range. Please note as well that the mechanical behaviour from our product will vary depending on the option elected.
- ➔ Any solutions not shown in this table need to get an official validation from the technical department prior installation.

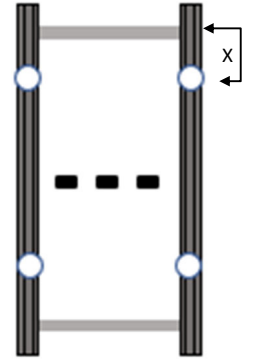
INSTALLATION OPTION

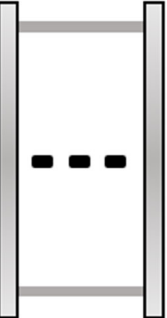
	a) DMMXSC	b) DMMXSCNi	c) DMMXSCNi_PG	d) DMMAXSCNi	e) DMMAXSCNi_PG	f) PSMXSCNi	g) PSMAXSCNi_PG
<p>Clamps long side</p> 	<p>X = 305 mm +/- 50 mm</p> <p>Clamp mini 50 mm</p> <p>Test load: +5400 Pa / -2400 Pa</p> <p>Design load: +3600 Pa / -1600 Pa</p>	<p>X = 305 mm +/- 50 mm</p> <p>Clamp mini 50 mm</p> <p>Test load: +5400 Pa / -2400 Pa</p> <p>Design load: +3600 Pa / -1600 Pa</p>	<p>X = 305 mm +/- 50 mm</p> <p>Clamp mini 50 mm</p> <p>Test load: +8100 Pa / -2400 Pa</p> <p>Design load: +5400 Pa / -1600 Pa</p>	<p>X = 305 mm +/- 50 mm</p> <p>Clamp mini 50 mm</p> <p>Test load: +5400 Pa / -2400 Pa</p> <p>Design load: +3600 Pa / -1600 Pa</p>	<p>X = 305 mm +/- 50 mm</p> <p>Clamp mini 50 mm</p> <p>Test load: +8100 Pa / -2400 Pa</p> <p>Design load: +5400 Pa / -1600 Pa</p>	<p>X = 305 mm +/- 20 mm</p> <p>Clamp mini 120 mm + EPDM</p> <p>Test load: +2400 Pa / -2400 Pa</p> <p>Design load: +1600 Pa / -1600 Pa</p>	<p>X = 305 mm +/- 20 mm</p> <p>Clamp mini 120 mm + EPDM</p> <p>Test load: +3600 Pa / -2400 Pa</p> <p>Design load: +2400 Pa / -1600 Pa</p>
<p>Clamps short side</p> 	<p>0 mm <X< 225 mm</p> <p>Clamp mini 50 mm</p> <p>Test load: +2400 Pa / -2400 Pa</p> <p>Design load: +1600 Pa / -1600 Pa</p>	<p>0 mm <X< 225 mm</p> <p>Clamp mini 50 mm</p> <p>Test load: +2400 Pa / -2400 Pa</p> <p>Design load: +1600 Pa / -1600 Pa</p>	<p>0 mm <X< 225 mm</p> <p>Clamp mini 50 mm</p> <p>Test load: +2400 Pa / -2400 Pa</p> <p>Design load: +1600 Pa / -1600 Pa</p>	<p>0 mm <X< 195 mm</p> <p>Clamp mini 50 mm</p> <p>Test load: +2400 Pa / -2400 Pa</p> <p>Design load: +1600 Pa / -1600 Pa</p>	<p>0 mm <X< 195 mm</p> <p>Clamp mini 50 mm</p> <p>Test load: +2400 Pa / -2400 Pa</p> <p>Design load: +1600 Pa / -1600 Pa</p>		
<p>For Flat roof</p> 	<p>4 clamps on corner</p> <p>X = 0 mm Clamp mini 50 mm</p> <p>With 2 rails : Test load: +2400 Pa / -2400 Pa Design load: +1600 Pa / -1600 Pa</p> <p>With 3 rails Test load: +3600 Pa / -2400 Pa Design load: +2400 Pa / -1600 Pa</p>	<p>4 clamps on corner</p> <p>X = 0 mm Clamp mini 50 mm</p> <p>With 2 rails : Test load: +3000 Pa / -2400 Pa Design load: +2000 Pa / -1600 Pa</p> <p>With 3 rails Test load: +5400 Pa / -2400 Pa Design load: +3600 Pa / -1600 Pa</p>	<p>4 clamps on corner</p> <p>X = 0 mm Clamp mini 50 mm</p> <p>With 2 rails : Test load: +3000 Pa / -2400 Pa Design load: +2000 Pa / -1600 Pa</p> <p>With 3 rails Test load: +5400 Pa / -2400 Pa Design load: +3600 Pa / -1600 Pa</p>	<p>4 clamps on corner</p> <p>X = 0 mm Clamp mini 50 mm</p> <p>With 2 rails : Test load: +3000 Pa / -2400 Pa Design load: +2000 Pa / -1600 Pa</p> <p>With 3 rails Test load: +5400 Pa / -2400 Pa Design load: +3600 Pa / -1600 Pa</p>	<p>4 clamps on corner</p> <p>X = 0 mm Clamp mini 50 mm</p> <p>With 2 rails : Test load: +3000 Pa / -2400 Pa Design load: +2000 Pa / -1600 Pa</p> <p>With 3 rails Test load: +5400 Pa / -2400 Pa Design load: +3600 Pa / -1600 Pa</p>		

	a) DMMXSC	b) DMMXSCNi	c) DMMXSCNi_PG	d) DMMAXSCNi	e) DMMAXSCNi_PG	f) PSMXSCNi	g) PSMAXSCNi_PG
<p>With mounting holes Long side</p> 	<p>X = 305 mm +/- 50 mm</p> <p>Clamp mini 50 mm</p> <p>Test load: +5400 Pa / -2400 Pa</p> <p>Design load: +3600 Pa / -1600 Pa</p>	<p>X = 305 mm +/- 50 mm</p> <p>Clamp mini 50 mm</p> <p>Test load: +5400 Pa / -2400 Pa</p> <p>Design load: +3600 Pa / -1600 Pa</p>	<p>X = 305 mm +/- 50 mm</p> <p>Clamp mini 50 mm</p> <p>Test load: +8100 Pa / -2400 Pa</p> <p>Design load: +5400 Pa / -1600 Pa</p>	<p>X = 305 mm +/- 50 mm</p> <p>Clamp mini 50 mm</p> <p>Test load: +5400 Pa / -2400 Pa</p> <p>Design load: +3600 Pa / -1600 Pa</p>	<p>X = 305 mm +/- 50 mm</p> <p>Clamp mini 50 mm</p> <p>Test load: +8100 Pa / -2400 Pa</p> <p>Design load: +5400 Pa / -1600 Pa</p>		
<p>With mounting holes short side</p> 	<p>0 mm <X< 225 mm</p> <p>Clamp mini 50 mm</p> <p>Test load: +2400 Pa / -2400 Pa</p> <p>Design load: +1600 Pa / -1600 Pa</p>	<p>0 mm <X< 225 mm</p> <p>Clamp mini 50 mm</p> <p>Test load: +2400 Pa / -2400 Pa</p> <p>Design load: +1600 Pa / -1600 Pa</p>	<p>0 mm <X< 225 mm</p> <p>Clamp mini 50 mm</p> <p>Test load: +2400 Pa / -2400 Pa</p> <p>Design load: +1600 Pa / -1600 Pa</p>	<p>0 mm <X< 195 mm</p> <p>Clamp mini 50 mm</p> <p>Test load: +2400 Pa / -2400 Pa</p> <p>Design load: +1600 Pa / -1600 Pa</p>	<p>0 mm <X< 195 mm</p> <p>Clamp mini 50 mm</p> <p>Test load: +2400 Pa / -2400 Pa</p> <p>Design load: +1600 Pa / -1600 Pa</p>		
<p>With insertion profiles</p> 	<p>Test load: +2400 Pa / -2400 Pa</p> <p>Design load: +1600 Pa / -1600 Pa</p>	<p>Test load: +2400 Pa / -2400 Pa</p> <p>Design load: +1600 Pa / -1600 Pa</p>	<p>Test load: +2400 Pa / -2400 Pa</p> <p>Design load: +1600 Pa / -1600 Pa</p>	<p>Test load: +2400 Pa / -2400 Pa</p> <p>Design load: +1600 Pa / -1600 Pa</p>	<p>Test load: +2400 Pa / -2400 Pa</p> <p>Design load: +1600 Pa / -1600 Pa</p>		

All above data are given based on module resistance. It is on the installer to elect a mounting instruction having at least same behaviour than the module.

The whole solution needs to be evaluated by the solution supplier for the set “PV module + mounting system + clamp system”.

- All accessories such as bolt, screws and other metal parts are corrosion-proof and exempt of any chemical reaction with the frame of the solar module.
- Make sure that the module's junction boxes are not in contact with any metal part belonging to the mounting structure.
- Make sure that module's cables are not damaged and not in mechanical stress.
- Make sure that the mounting system or any sharp component are not in contact with the surface of the modules nor the foil or glass backside.

Recommendation for slope and orientation of our products:

For the installations in the Southern Hemisphere, the best orientation of residential solar would be north, and for Northern Hemisphere installations the best direction for solar panels to face is south.

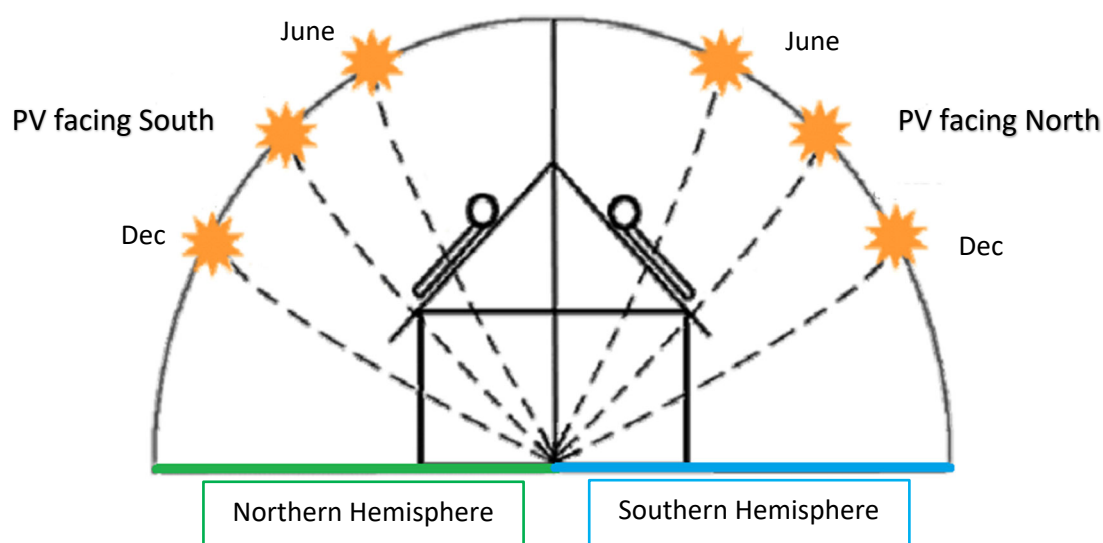

- To obtain the best module efficiency, slope need to be considered as well and need to be check on site. However, we recommend a minimal slope of 10° for a good water evacuation. Horizontal installation is also permitted but we would recommend to work with our framed double glass product for this case.

Recommendation for installation in severe environment:

- All our products have been tested in laboratory for mechanical test resistance. For severe environment installation where modules may face a level IV Load, we recommend to use in priority the Framed Glass Glass modules tested and proofed with higher mechanical resistance.

For installation on high level where snow load can reach level above 4000 Pa, we recommend also an horizontal installation with a cross bracing solution allowing a clamping on long side and respecting previous instructions (cf page 15 and 16).

For any doubts linked to the installation of our products in a severe environment, soluxtec can offer a technical support. Please contact us on info@soluxtec.de

7 ELECTRICAL INSTALLATIONS

PRECAUTION for individual protection

Please make sure to wear your individual protection equipment.

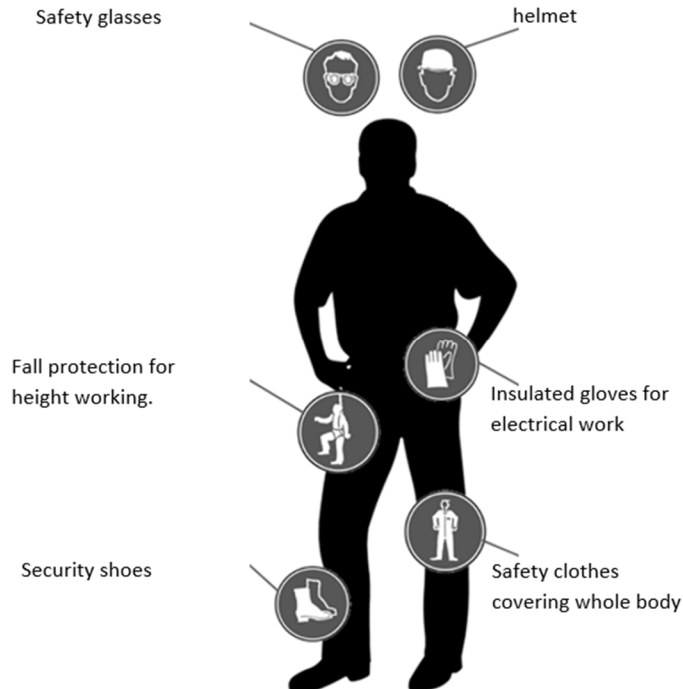

This photovoltaic system produces DC electricity when exposed to sunlight. Avoid contact with exposed terminal: So no connect or disconnect plus contacts while system is under load current.

All data from module Power label are given under STC conditions:

- 1000 W/m²
- 25°C
- AM 1,5

Fire resistance : C in accordance to UL790

Max test voltage : 1500 VDC

Overcurrent protection rating : 25 A

Safety class : II

WIRING AND PLANNING

- Before starting with modules wiring, a visual inspection is recommended to make sure that all module's components are in a good shape.
- The final wiring conception is determinate in function to the final project on site. Modules deployed for a given project should present the same technical characteristics to prevent any mismatching.
- PV modules can be connected in serial or in parallel.

- In serial:

total voltage is the sum of each module voltage
(in serial we add voltage, we do not add intensities)

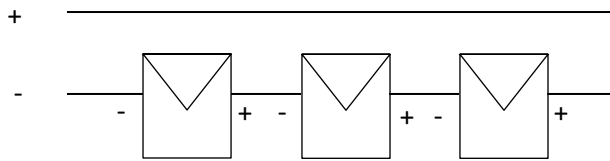

- In parallel:

total intensity is the sum of the serial lines in parallel (in parallel we add the intensities)

total voltage is the sum of each module voltage in from 1 line
(in parallel we do not add the voltage)

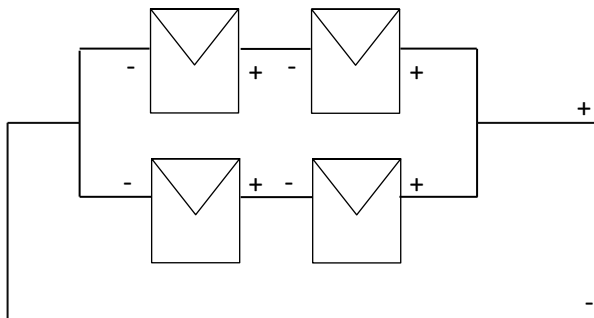

Note: When a project is wired with modules in parallel, it is important to check at the fuse rating of the module. This value is available on the module's label as well as on the dedicated data sheet. Indeed, in case of 1 line shadowing, the line that is still producing energy will "load" the other. This is why an appropriate line fuse protection must be applied and following appropriate standards.

- The maximal overall voltage of a pv generator need to take into consideration the worst-case scenario. It means that we need to consider the Voltage open circuit and the minimal temperature on site.

You can calculate it with the following formula:

$$\text{Max system voltage} = N \times U_{oc} [1 + T_{cU_{oc}} \times (T_{min} - 25^{\circ})]$$

Where:

N=number of modules in serial

Uoc = Open circuit voltage of a module

TcUoc = Temperature coefficient at open circuit voltage

Tmin = Minimal temperature on project site

- The cables section from our products is always given at 4mm², cables are always UV resistant and qualified for direct current (DC). This section is enough for a single component. However, and depending on the configuration of the pv generator, it is recommended to check at the maximal

short circuit current from the whole project in order to elect the right cables cross section in respect to the local standards.

- The planning of the wiring of the PV system should consider a tight loop wiring of the plus and minus line. The area enclosed by the conductors should be kept as small as possible (here in grey). This reduces the risk of inductive coupling caused by lightning strokes.

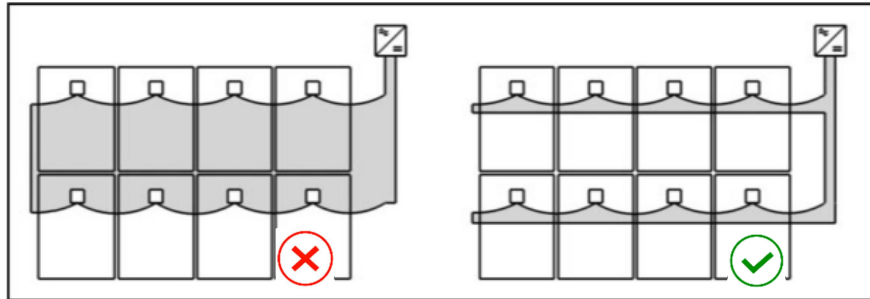

- Connectors need to be kept dry and clean. When wiring connectors together, make sure that both are from same manufacturer and same reference. When well connected, you must listen a “click” confirming the right connection.



A bad connection may result into arcs and electrical shock. Arcs may also be the origin of a fire departure. This point is extremely important.

- All framed modules need to be connected together with a grounding solution to the main equipotential bonding of the project location. On each module, you can find 4 different locations allowing the grounding bonding and mark with this logo:

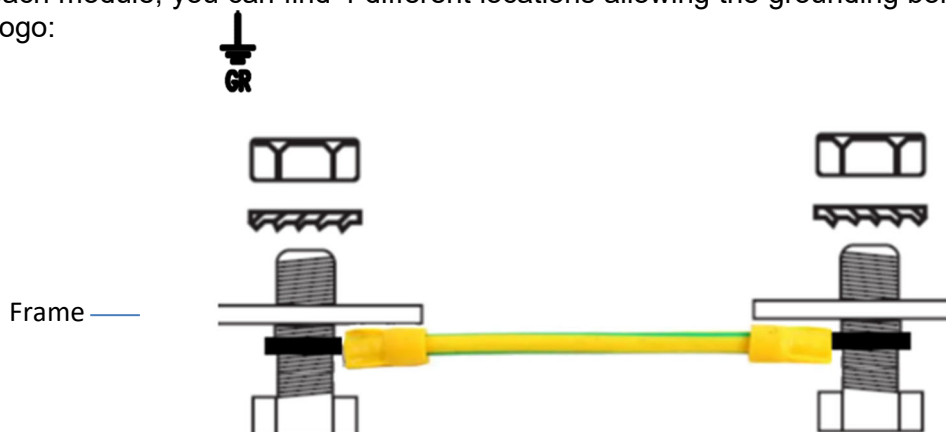

It is recommended to use a 10 mm² bonding connector to realize the grounding between each module. The recommended section to the main equipotential bonding is 16 mm². The legal standard from the installation place might be different and need to be follow in priority.

8 MAINTENANCE AND CLEANING:

SOLUXTEC Pv modules are offered with a long-lasting operating life together with a low level of maintenance.

SOLUXTEC recommend a yearly inspection from a qualified company and ideally from the company having realised the installation in order to control the efficiency of the complete generator.

Dust or pollution from the environment may remain on pv modules surface. It is recommended to clean the surface of the modules only with a soft broom and water, an alcohol based cleaner solution is also allowed.

For any issues with SOLUXTEC's products you can contact us from the email address info@soluxtec.de.
SOLUXTEC'S technical service will support you.

SOLUXTEC

made in Germany.

SOLUXTEC GmbH

Werner von Siemens Str. 25

D-54634 Deutschland

HRB Wittlich 41318

Info@soluxtec.de

