



Quick Installation Guide

X3-MIC G2 Series 3 kW-15 kW

II

Inverter Installation

1 - Unscrew the bracket from the back of the inverter.

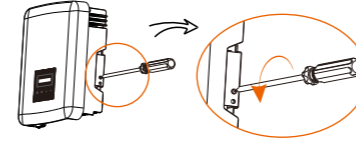

1

2 - And mark the position (223 mm*30 mm) of the three holes.

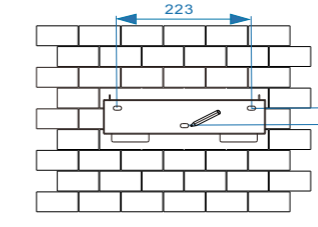

2

3 - Drill holes with $\phi 10$ drill.
- Depth: at least 60 mm.

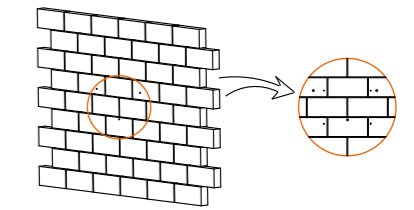

3

4 - Insert the expansion bolts.

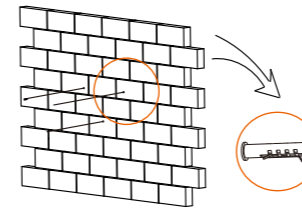

4

5 - Screw the self tapping screws.

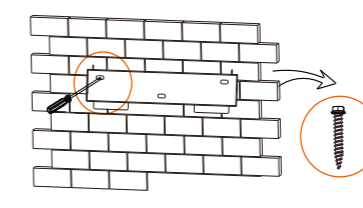

5

6 - Match the inverter with the bracket.
- Screw the cross recessed screw on the right side.

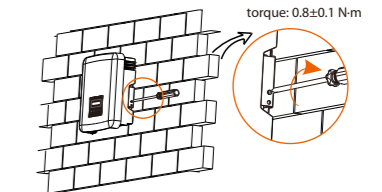

6

torque: 0.8 ± 0.1 N·m

I

Packing List

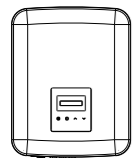

Inverter X 1



Expansion bolt X 3
Self tapping screw X 3



Round washer X 3

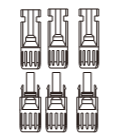

DC connector X 4/6*



DC pin contact X 4/6*

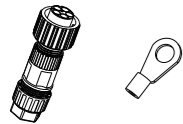

AC connector X 1
Earth terminal X 1

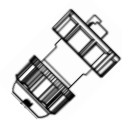

Waterproof connector with RJ45 X 1

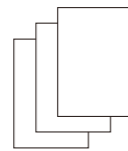

Documents

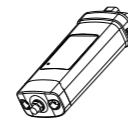

WiFi dongle (Optional)

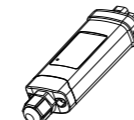

LAN dongle (Optional)

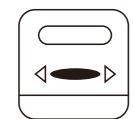

Meter (Optional)

★ 2*positive, 2*negative for 3 kW-8 kW and 10 kW(input A: one string)
3*positive, 3*negative for 12 kW-15 kW and 10 kW(input A: two strings)
* For the optional accessories, please be subject to the actual delivery.
Note: Please refer to the appropriate instruction manual for the usage of WiFi and LAN dongle.

III

PV Connection

cable size: 4 mm^2

strip length $\rightarrow 7 \text{ mm} \leftarrow$

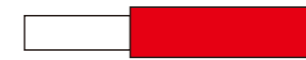

- Align the PV connectors.

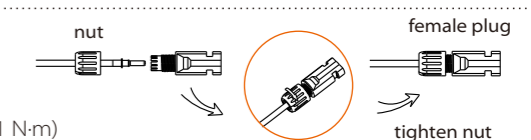
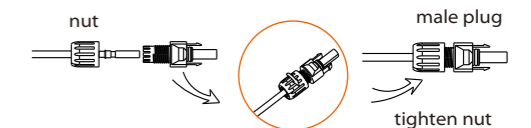
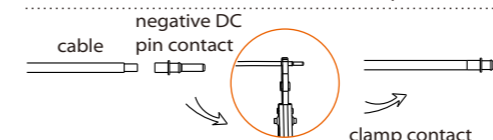
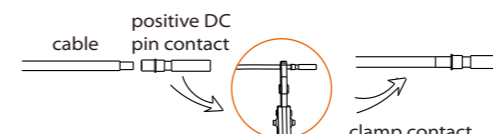
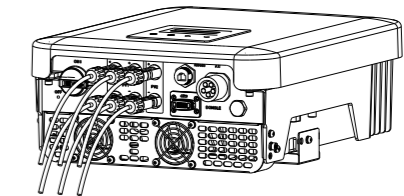

(torque: 1.2 ± 0.1 N·m)

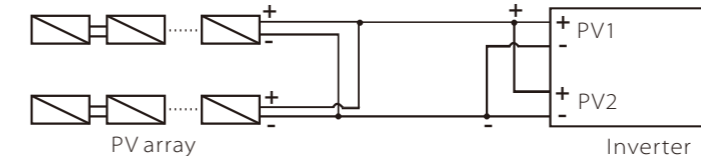

Note!
The PV connection mode in this box is **not allowed!**

IV

AC Connection

Select appropriate cable according to the power range as recommended in "Table: Cable and Micro-breaker recommended" of the manual and strip the wires as below.

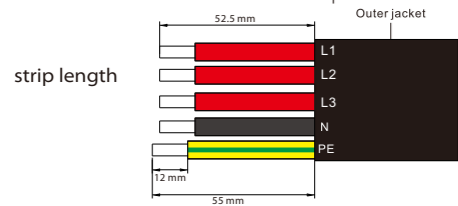

1. Slide the cable nut and back shell onto the cable.
2. Insert the stripped end of the five wires into the appropriate holes of the male insert (The N wire and PE wire must be connected correctly), then tighten each screw (Use the accompanying inner hexagon spanner).

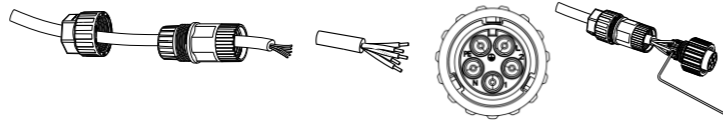

3. Tighten the screw of the back shell and the male insert.



4. Tighten the screw of the back shell and the cable nut.

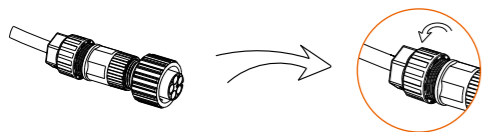

5. Align the groove of male terminal with the convex of female terminal, then tighten the bush in male terminal.

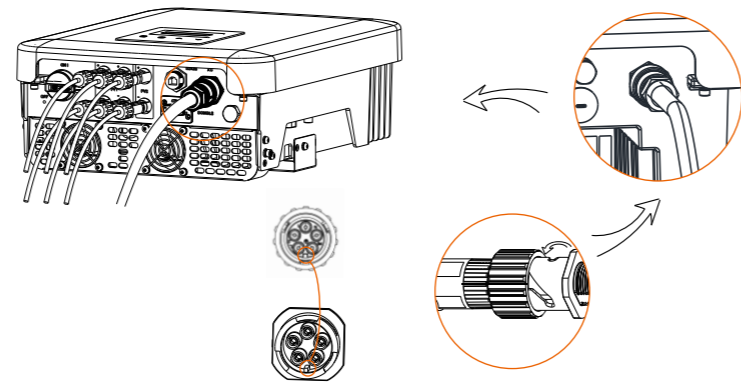

V

Earth Connection and Overview

- Screw the ground screw with the allen wrench shown as follows.

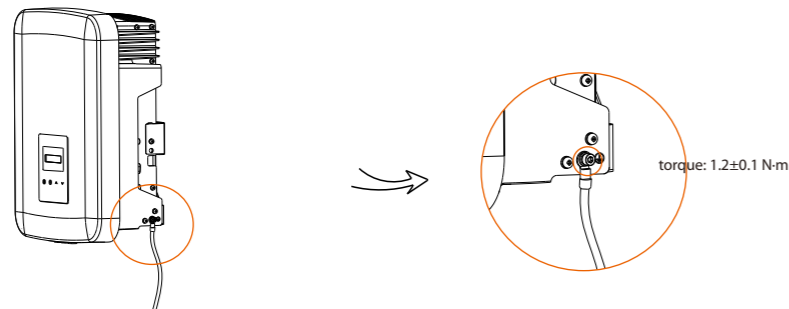

- Overview for connection.

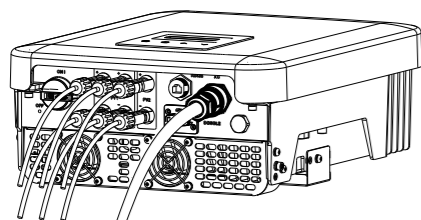

Start inverter:

1. Turn on the external AC and DC connectors;
2. Turn on the DC switch to the "ON" position;
3. Inverter will start automatically when PV panels generate enough energy, the LED will be blue.

VI

WiFi Connection (Optional)

- This inverter provides a monitoring dongle connecting port (the DONGLE port) which can collect information from inverter including status, performance and updating information to the monitoring website via connecting WiFi/LAN/4G dongle (The monitoring dongle is optional, which can be purchased from the supplier if needed).
- For example, plug the WiFi dongle into the port named "DONGLE" on bottom of the inverter.

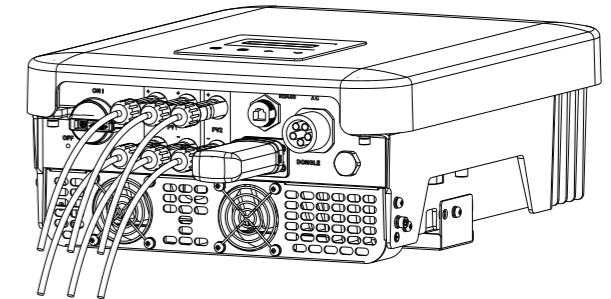
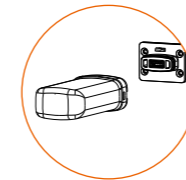

Note:

For details on the usage of WiFi and other monitoring dongles, please refer to the corresponding instruction manuals.

VII

USB Connection (for upgrading)

- 1) Make sure the DC switch is off and the AC is disconnected with grid. Remove the WiFi dongle module.

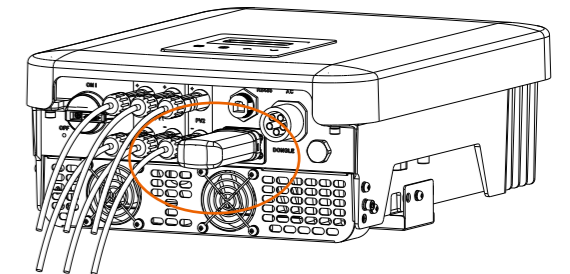
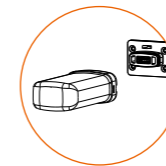

- 2) Insert U-disk with **upgrade package*** into the DONGLE port on the bottom of the inverter. Then turn on DC switch and connect the PV connector, the LCD will show a picture as on the right.

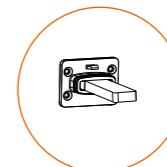
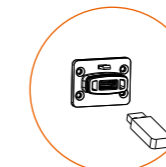

- 3) Press "Up" and "Down" to select ARM or DSP. Then long press "Down" and select the correct update file to confirm the update. After the upgrade is completed, please remember to turn off the DC switch or disconnect the PV connector, then pull off the U-disk, and connect the WiFi dongle back.

* Please contact our service support to get the update package, and extract it into your U-disk. Do not modify the program file name! Or it may cause the inverter to stop working!