

Installation / User Manual

Micro Inverter (Integrated NS Protection Device)
(Built-in WIFI-G3)

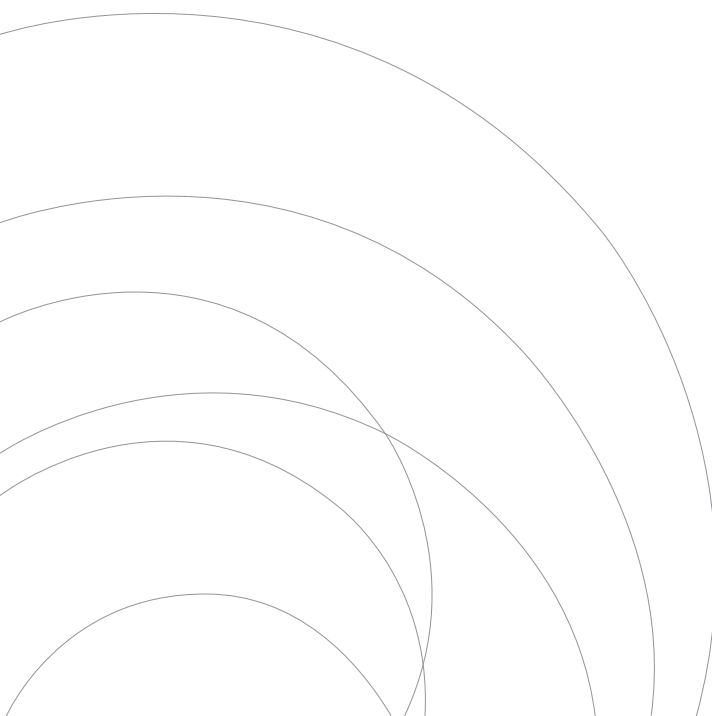

Table of Contents

Important Safety Instructions	01-03
Safety Instructions	
Radio Interference Statement	
The Meaning of Symbols	
Micro Inverter System Introduction	03-06
Microinverters Maximize PV Energy Production	
More Reliable than Centralized or String Inverters	
Simple to Install	
Micro Inverter Introduction	06
Micro Inverter System Installation	07-12
Required Parts and Tools from You	
Parts list	
Installation Procedures	
Micro Inverter System Operating Instructions	12-13
Troubleshooting	13-15
Status Indications and Error Reporting	
Troubleshooting a Non-operating Micro Inverter	
Replacement	16
Technical Data	16-18
M60 / 80 /100 G3 Micro Inverter Datasheet	
Wiring Diagram	19-20
Monitoring Platform	21
How to connect the SUN-MI-RELAY-01 to the Micro Inverter via web	22-25
How to connect the Micro Inverter to the router via web	26-29
How to connect in APP	30-31
EU Declaration of Conformity	32

Important Safety Instructions

This manual contains important instructions to follow during installation and maintenance of the Photovoltaic Grid-connected Inverter(Micro Inverter).To reduce the risk of electrical shock and ensure the safe installation and operation of the Micro Inverter the following symbols appear throughout this document to indicate dangerous conditions and important safety instructions.

Specifications subject to change without notice - please ensure you are using the latest manual found at the manufacturer website.

WARNING: This indicates a situation where failure to follow instructions may cause a serious hardware failure or personnel danger if not applied appropriately. Use extreme caution when performing this task.

NOTE: This indicates information that is important for optimized Micro Inverter operation. Follow these instructions strictly.

Safety Instructions

- ✓ **DO NOT** disconnect the PV module from the Micro Inverter without disconnecting the AC power.
- ✓ Only qualified professionals should install and/or replace the Microinverters.
- ✓ Perform all electrical installations in accordance with local electrical codes.
- ✓ Before installing or using the Micro Inverter, please read all instructions and cautionary markings in the technical documents and on the Micro Inverter system and the solar-array.
- ✓ Be aware that the body of the Micro Inverter is the heat sink and can reach a temperature of 80°C. To reduce risk of burns,do not touch the body of the Microinverter.
- ✓ **DO NOT** attempt to repair the Micro Inverter. If it fails, contact technical support to obtain an RMA number and start the replacement process. Damaging or opening the Micro Inverter will void the warranty.
- ✓ Caution!
The external protective earthing conductor is connected to the inverter protective earthing terminal through AC connector.
When connecting, connect the AC connector first to ensure the inverter earthing then do the DC connections.
When disconnecting, disconnect the AC by opening the branch circuit breaker first

but maintain the protective earthing conductor in the branch circuit breaker connect to the inverter ,then disconnect the DC inputs.

- ✓ In any circumstance, do not connect DC input when AC connector is unplugged.
- ✓ Please install isolation switching devices on the AC side of the inverter.

Radio Interference Statement

The equipment could radiate radio frequency energy and this might cause harmful interference to radio communications if not following the instructions when installing and using the equipment. But there is no guarantee that interference will not occur in a particular installation. If this equipment causes harmful interference to radio or television reception,the following measures might resolve the issues:

- A) Relocate the receiving antenna and keep it well away from the equipment.
- B) Consult the dealer or an experienced radio / TV technical for help.

Changes or modifications not expressly approved by the party responsible for compliance may void the user's authority to operate the equipment.

WiFi information







Frequency range:2.412~2.472GHz

WiFi maximum transmitting power:16dBm \pm 2dBm

Antenna: External Antenna

Antenna Gain:3.00dBi

The Meaning of Symbols

Can be OEM Trademark.	
	Caution, risk of electric shock.
	Caution, risk of burn - Do not touch.
	Caution, hot surface.
	Symbol for the marking of electrical and electronics devices according to Directive 2002/96/EC. Indicates that the device, accessories and the packaging must not be disposed as unsorted municipal waste and must be collected separately at the end of the usage. Please follow Local Ordinances or Regulations for disposal or contact an authorized representative of the manufacturer for information concerning the decommissioning of equipment.
	CE mark is attached to the solar inverter to verify that the unit follows the provisions of the European RED Directives.
	Refer to the operating instructions.
Qualified personnel	Person adequately advised or supervised by an electrically skilled person to enable him or her to perceive risks and to avoid hazards which electricity can create. For the purpose of the safety information of this manual, a "qualified person" is someone who is familiar with requirements for safety, refrigeration system and EMC and is authorized to energize, ground, and tag equipment, systems, and circuits in accordance with established safety procedures. The inverter and endues system may only be commissioned and operated by qualified personnel.

Micro Inverter System Introduction

The Micro Inverter is used in utility-interactive grid-tied applications, comprised of three key elements:

- Micro Inverter
- SUN-MI-RELAY-01 (Network and System Protection Device)
- Router

This series Micro Inverter has built-in WIFI module so it can communicate with router directly.

M60 / 80 / 100G3

SUN-MI-RELAY-01(Network and System Protection Device): it is used to monitoring and disconnect the grid when sensing the grid voltage/frequency is out of the allowed range. The relay kit also is able to reconnect grid when the grid conditions resume. It must communicate with the built-in wifi module of the Micro Inverter, the Micro Inverter can work normally, otherwise the Micro Inverter can not work. The localhost of this relay kit is 10.10.101.254.

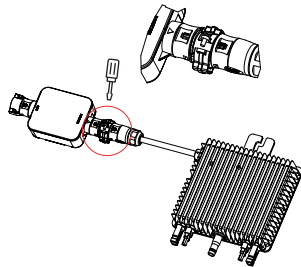
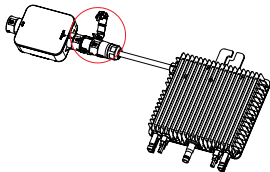
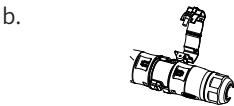
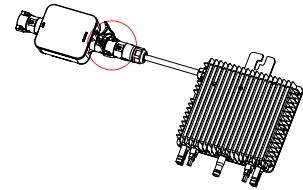
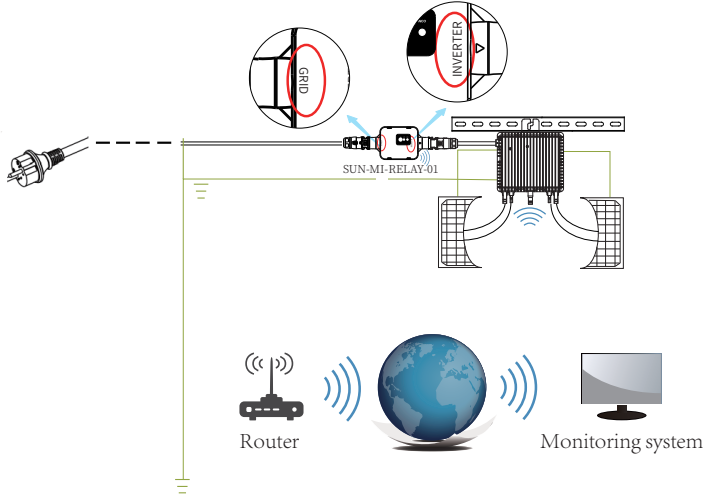

NOTE: For the connection between SUN-MI-Relay-01(Network and System Protection Device) and Micro Inverter, the tool(screwdriver) is needed.

WARNING: The Micro Inverter SUN-M60G3-EU-Q0-RE, SUN-M80G3-EU-Q0-RE, SUN-M100G3-EU-Q0-RE shall not be put into operation without external relay kit SUN-MI-RELAY-01.

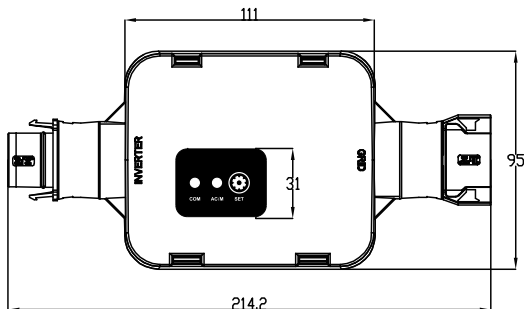

Name	Functions
● COM	Show the wireless connection Status.
● AC/M	Show the Grid Status.
⚙️ SET	All you set parameters and test the device.

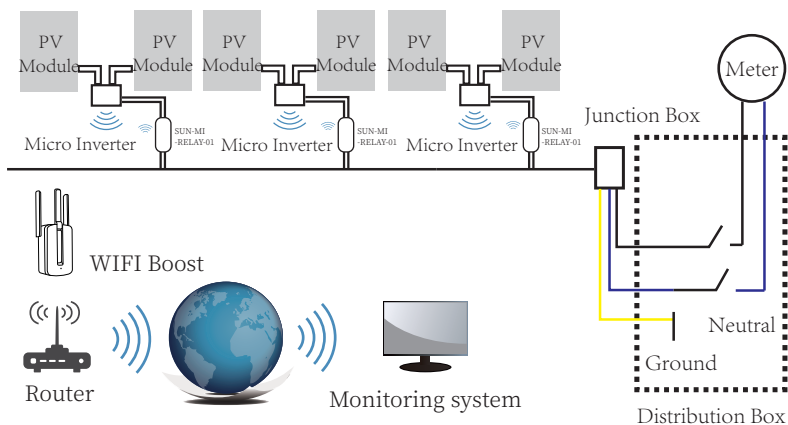

Inverter Model	SUN-M60G3-EU-Q0-RE	SUN-M80G3-EU-Q0-RE	SUN-M100G3-EU-Q0-RE
PV Input Voltage	42.5V (20V~60V)		
PV Array MPPT Voltage Range	25V~55V		
No. of MPP Trackers	2		
No. of Strings per MPP Tracker	1		

NOTE: If the wireless signal in the area where the Micro Inverter is installed is weak, it is necessary to add a wifi signal booster at a suitable place between the router and the Micro Inverter.

This integrated system improves safety; maximizes solar energy harvest; increases system reliability, and simplifies solar system design, installation, maintenance, and management.

Microinverters Maximize PV Energy Production

Each PV module has individual Maximum Peak Power Tracking (MPPT) controls, which ensures that the maximum power is exported to the utility grid regardless of the performance of the other PV modules in the array. When PV modules in the array are affected by shade, dust, orientation, or any situation in which one module underperforms compared with the other units, the Micro Inverter ensures top performance from the array by maximizing the performance of each module within the array.

More Reliable than Centralized or String Inverters

The distributed Micro Inverter system ensures that no single point of system failure exists across the PV system. Microinverters are designed to operate at full power at ambient outdoor temperatures of up to 113°F (45°C). The inverter housing is designed for outdoor installation and complies with the IP67 environmental enclosure rating.

Simple to Install

You can install individual PV modules in any combination of Module quantity, orientation, different type and power rate. The Ground wire (PE) of the AC cable is connected to the chassis inside of the Micro Inverter, potentially eliminating the installation of grounding wire (check local regulation).

Data collection adopts internal wifi, wireless router is needed near the Micro Inverter. When complete the installation of Micro Inverter, configure wireless router with internal wifi (refer to the wifi user manual). The data will be uploaded automatically. Users can monitor and manage the Micro Inverter through corresponding website or APP.

Micro Inverter Introduction

The Microinverters connect with the single-phase grid, and can also use multiple Microinverters in the form of single-phase grid to achieve three-phase grid.

For more information, please see the Technical Data page (P17) of this manual.

Model Number	AC grid	Max. # Per branch
SUN-M60G3-EU-Q0-RE	50/60Hz, 230V	8 for 25A breaker
SUN-M80G3-EU-Q0-RE	50/60Hz, 230V	6 for 25A breaker
SUN-M100G3-EU-Q0-RE	50/60Hz, 230V	5 for 25A breaker

Micro Inverter System Installation

A PV system using Microinverters is simple to install. Each Micro Inverter easily mounts on the PV racking, directly beneath the PV module(s). Low voltage DC wires connect from the PV module directly to the Micro Inverter, eliminating the risk of high DC voltage. Installation MUST comply with local regulations and technical rules.

WARNING: Perform all electrical installations in accordance with local electrical codes.

WARNING: Be aware that only qualified professionals should install and/or replace Microinverters.

WARNING: Before installing or using an Micro Inverter, please read all instructions and warnings in the technical documents and on the Micro Inverter system itself as well as on the PV array.

WARNING: Be aware that installation of this equipment includes the risk of electric shock.

NOTE: Strongly recommend to install Surge protection Devices in the dedicated meter box.



Required Parts and Tools from you

In addition to your PV array and its associated hardware, you will need the following items:

- An or several AC connection junction boxes
- Mounting hardware suitable for module racking
- Sockets and wrenches for mounting hardware
- Continuous grounding conductor and grounding washers
- A Phillips screwdriver
- A torque wrench

Parts list

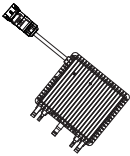
Please check the following table, to see whether all the parts are included in the package:

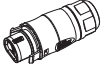
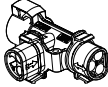
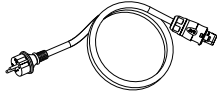
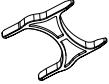
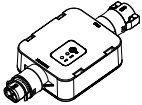
 <p>Micro Inverter x1</p>	 <p>User manual x1</p>	 <p>AC extension cable (optional) x N-1</p>
 <p>Bus AC connector (optional) x1</p>	 <p>T-connector (optional) x N-1</p>	 <p>Extension cable with European standard plug (optional) x 1</p>
 <p>Clip x1</p>	 <p>SUN-MI-RELAY-01 (Network and System Protection Device) x1</p>	

* Choose either Bus AC connector or Extension cable with European standard plug, can't use them in the same project.

Installation Procedures

Step 1 - Install the AC branch circuit junction box

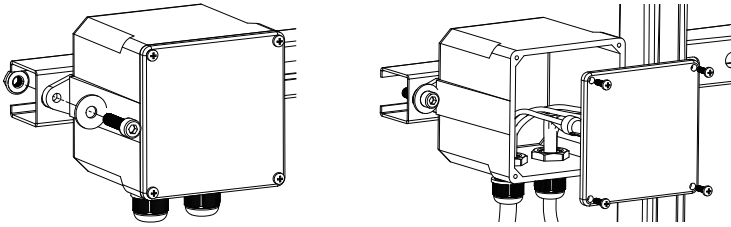

- Install an appropriate junction box at a suitable location on the PV racking system (typically at the end of a branch of modules).
- Connect the open wire end of the AC cable into the junction box using an appropriate gland or strain relief fitting.
- Connect the AC branch circuit junction box to the point of utility Grid Interconnection (Usually it is inside a distribution box).

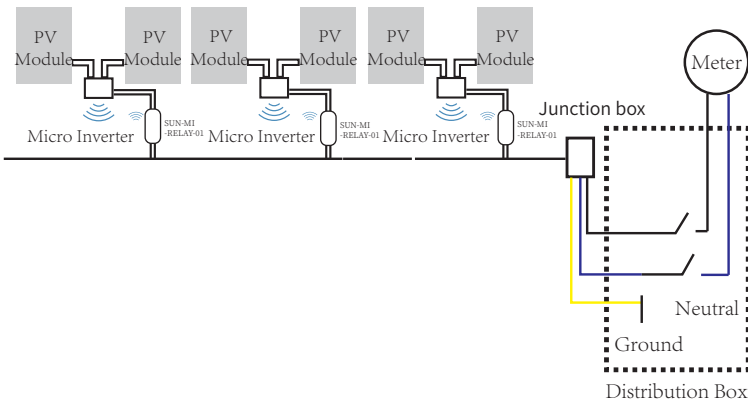

WARNING: Wiring colour code can be different according local regulation, check all the wires of the installation before connecting to the AC cable to be sure they match. Wrong cabling can damage irreparably the microinverters, such an issue is not covered by the warranty.

Step 2 - Attach the Microinverters to the racking or the PV module frame

- Mark the location of the Micro Inverter on the rack, with respect to the PV module and junction box or any other obstructions.
- Mount one Micro Inverter at each of these locations using hardware recommended by your module racking vendor.

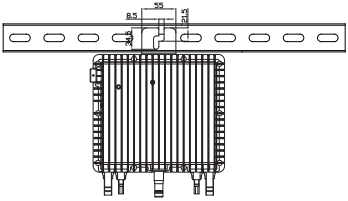

M60 / 80 / 100 G3 (2MPPT)

Mounting

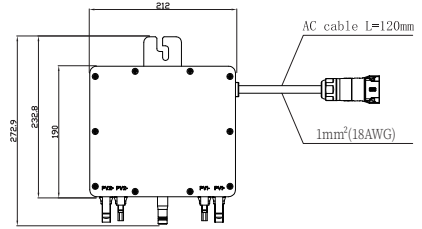

The AC wire on the micro inverter is a TC-ER wire with a wire cross-section area of 1mm²(18AWG).

WARNING: Prior to installing any of the microinverters, verify that the utility voltage at the point of common connection matches the voltage rating on Micro Inverter label.

WARNING: Do not place the inverters (including DC and AC connectors) where exposed to the sun, rain or snow, even gap between modules. Allow a minimum of 3/4 (1.5cm.) between the roof and the bottom of the Micro Inverter to allow proper air flow.

Step 3 - Connect the microinverters in parallel

- a. Check the Micro Inverter technical data page 5 for the maximum allowable number of Microinverters on each AC branch circuit.
- b. As to parallel connection, please refer to page (P19-P20), use the T-connector, AC extension cable, Bus AC connector(If only one branch, just use the Extension cable with European standard plug) to connect the Micro Inverter in each branch.

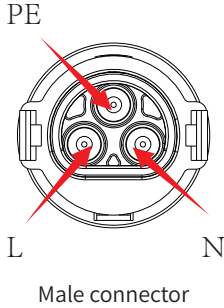

Model	Wire Size	Cable(mm) ²	Torque value(max)	Max cable length
SUN-M60G3-EU-Q0-RE	12AWG	2.5	8.5Nm	Outside cable (L+N+PE)20m
SUN-M80G3-EU-Q0-RE	12AWG	2.5	8.5Nm	
SUN-M100G3-EU-Q0-RE	12AWG	2.5	8.5Nm	

WARNING: DO NOT exceed maximum number of Microinverters in an AC branch circuit, as displayed on the page 5 of this manual.

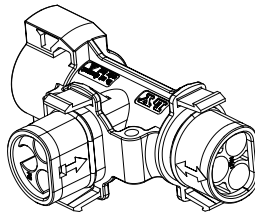

T-connector

NOTE: Port marked with two-way arrow on T-type plug can only connect with extended cable and Port marked with one-way arrow on T-type plug can only connect with Micro Inverter.

Step 4 - Connect the wire open of branch end to the junction box.

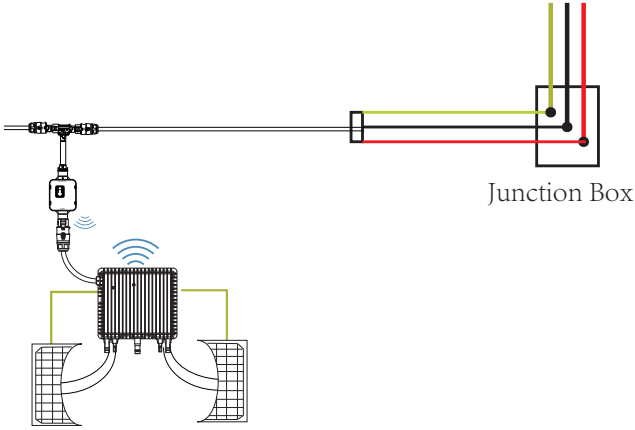

Step 5 - Connect Micro Inverter to the PV Modules

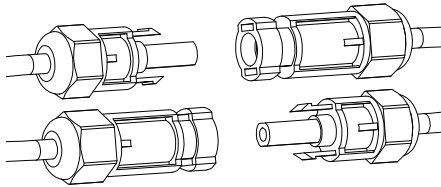

General Guidelines:

- PV modules should be connected to DC input ports of a Micro Inverter.
- In order to meet the relevant regulatory requirements, the cable length must be <math><3M</math>. Please consult the local power operator to make sure that the DC cable complies with local regulations.

NOTE: When plugging in the DC cables, if AC already available, the Micro Inverter should immediately blink red light and will start work within the setting time (default 60 seconds). If AC is not available, the red light will blink 3 times quickly and repeat after one second until AC is connected.

Micro Inverter System Operating Instructions

To operate the Micro Inverter PV system:

- Turn ON the AC circuit breaker on each Micro Inverter AC branch circuit.
- Turn ON the main utility-grid AC circuit breaker. Your system will start producing power after a one-minute waiting time.

-
-
3. The units should start blinking red one minutes after turning on the AC circuit breaker. Then blue led blinking. This means they are producing power normally, the faster blinking of the blue led means more power generated.
 4. Configure the internal wifi module according to its user manual.
 5. The Microinverters will start to send performance data over wifi module to the network every 5 minutes.It enables customers to monitor performance data of each Micro Inverter through website and APP.

When AC power is applied but the Micro Inverter not started up, about 0.1A current and 25VA power for each Micro Inverter may be measured by a power meter. This power is reactive power,not consume from utility grid.

Troubleshooting

Qualified personnel can use the following troubleshooting steps if the PV system does not operate correctly:

Status Indications and Error Reporting

Start up LED

One minute after DC power is first applied to the Micro Inverter,one short red blinks indicate a successful Micro Inverter startup sequence, be equal or greater than two short red blinks after DC power is first applied to the Micro Inverter indicate a failure during Micro Inverter setup.

Operation LED

Flashing Slow Blue	- Producing small power
Flashing Fast Blue	- Producing big power
Flashing Red	- Not producing power
Red blinking two times	- AC low-voltage or high-voltage
Red blinking three times	- Grid failure

GFDI Error

A four time red LED indicates the Micro Inverter has detected a Ground Fault Detector Interrupter (GFDI) error in the PV system. Unless the GFDI error has been cleared, the LED will remain four times blinking.

Other Faults

All other faults can be reported to the website and APP.

WARNING: Never disconnect the DC wire connectors under load. Ensure that no current is flowing in the DC wires prior to disconnecting. An opaque covering may be used to cover the module prior to disconnecting the module.

Troubleshooting a non-operating Micro Inverter

There are two possible overall areas of trouble:

- A. The Micro Inverter itself may be having problems.
- B. The Micro Inverter itself is working fine but the communication between Micro Inverter and network has problem. The items below refer to Micro Inverter issues, not communication issues:

One quick way to tell whether the issue is the Micro Inverter or the communication problem:

Diagnosing from the network:

- a. No-Data-Display: The website and APP don't display any data. Check the network configuration.
- b. Only display Micro Inverter is online but no data. This may be because server is updating.

To troubleshoot a non-operating Micro Inverter, Follow the steps below in order:

1. Verify the utility voltage and frequency are within ranges shown in the Technical Data section of this manual.
2. Check the connection to the utility grid. Disconnect AC firstly, then disconnect DC and make sure the utility grid voltage can be measured at AC connector. Never disconnect the DC wires while the Micro Inverter is producing power. Re-connect the DC module connectors and watch for three short LED flashes.
3. Check the AC branch circuit interconnection between all the microinverters. Verify each inverter is energized by the utility grid as described in the previous step.
4. Make sure that any AC breaker are functioning properly and are closed.
5. Check the DC connections between the Micro Inverter and the PV module.
6. Verify the PV module DC voltage is within the allowable range shown in the Technical Data of this manual.
7. If the problem still persists, please contact technical support.

WARNING: Do not attempt to repair the Micro Inverter. If troubleshooting methods fail, please call for Technical Support

Replacement

Follow the procedure to replace a failed Micro Inverter

- A. Disconnect the Micro Inverter from the PV Module, in the order shown below:
1. Disconnect the AC by turning off the branch circuit breaker.
 2. Disconnect the AC connector of the Micro Inverter.
 3. Cover the module with an opaque cover.
 4. Disconnect the PV module DC wire connectors from the Micro Inverter.
 5. Remove the Micro Inverter from the PV array racking.
- B. Install a replaced Micro Inverter to the bracket then remove the opaque cover. Remember to observe the flashing LED light as soon as the new Micro Inverter is plugged into the DC cables.
- C. Connect the AC cable of the replacement Micro Inverter.

Technical Data

WARNING: Be sure to verify the voltage and current specifications of your PV module match with those of the Micro Inverter. Please refer to the datasheet or user manual.

WARNING: You must match the DC operating voltage range of the PV module with the allowable input voltage range of the Micro Inverter.

WARNING: The maximum open circuit voltage of the PV module must not exceed the specified maximum input voltage of the inverter.

M60G3/80G3/100G3 Microinverter Datasheet

Model	SUN-M60G3 -EU-Q0-RE	SUN-M80G3 -EU-Q0-RE	SUN-M100G3 -EU-Q0-RE
Input Data (DC)			
Recommended input power(STC)	210-420W(2 Piece)	210-560W(2 Piece)	210-700W(2 Piece)
Maximum input DC voltage	60V		
MPPT Voltage Range	25~55V		
MPPT Full Power Voltage Range(V)	30V-55V	33V-55V	40V-55V
Min.DC input voltage(V)	20V		
Max DC short circuit current	19.5Ax2		
Max input current	13Ax2		
Output Data (AC)			
Rated output Power	600W	800W	1000W
Max.AC Output Apparent Power	600VA	800VA	1000VA
Rated AC output current	2.7A	3.5A	4.4A
Max.AC Output Current	2.7A	3.5A	4.4A
Nominal voltage / range	230V/ 0.85Un-1.1Un		
Nominal frequency	50/60Hz		
Extended frequency / range	45~55Hz / 55~65Hz		
Power factor	1		
Maximum unit per branch	8	6	5
Max. allowed altitude operating	2000m		
Max.inverter backfeed current to the array	0A		
Max output fault current	10A		
Efficiency			
CEC weighted efficiency	95%		
Peak inverter efficiency	96.5%		
Static MPPT efficiency	99%		
Night time power consumption	50mW		
Mechanical Data			
Ambient temperature range	-40 °C ~ 65 °C ,>45 °C derating		
Dimensions(W×H×D mm)	212W×190H×40D (Without mounting bracket and cable)		
Weight (kg)	2.8		
Cooling	Natural cooling		
Enclosure environmental rating	IP67		
Protective class	Class I		
Topology	Isolated HF Transformer		
Features			
Compatibility	Compatible with 60,72 cell PV modules		
Communication	WiFi / Zigbee		
Compliance	EN50549,VDE0126,VDE4105,IEC62109,CE,INMETRO		
Warranty	10 Years		

Technical Data

Model: SUN-MI-RELAY-01		Network and System Protection Device	
AC Input Data(Inverter)			
Nominal Voltage	220V/230V		
Nominal Frequency	50/60Hz		
Max AC Current	12A		
Nominal AC Current	12A		
Matching Inverter	Micro Inverter		
AC Output Data(Grid)			
Nominal Voltage	220V/230V		
Nominal Frequency	50/60Hz		
Max AC Current	12A		
Nominal AC Current	12A		
General Data			
Ambient Temperature Range	-40-65°C, >45°C derating		
Humidity	0%-100% RH		
Cabinet Size (WxHxD)	111mm*95mm*37.7mm (Excluding Connectors and Brackets)		
Weight	340g		
Enclosure Environmental Rating	IP67		
Communication	Wireless/Wifi		
Safety EMC / Standard	IEC/EN 6100-6-1/2/3/4, IEC/EN 62109-1, IEC/EN 62109-2, VDE-AR-N 4105		
WiFi information:			
Frequency range	2.412~2.472GHz		
WiFi maximum transmitting power	17dBm ± 1.5dBm		
Antenna	External Antenna		
Antenna Gain	3dBi		

Wiring Diagram

Sample Wiring Diagram Three Phase

M60G3/80G3/100G3 (2MPPT)

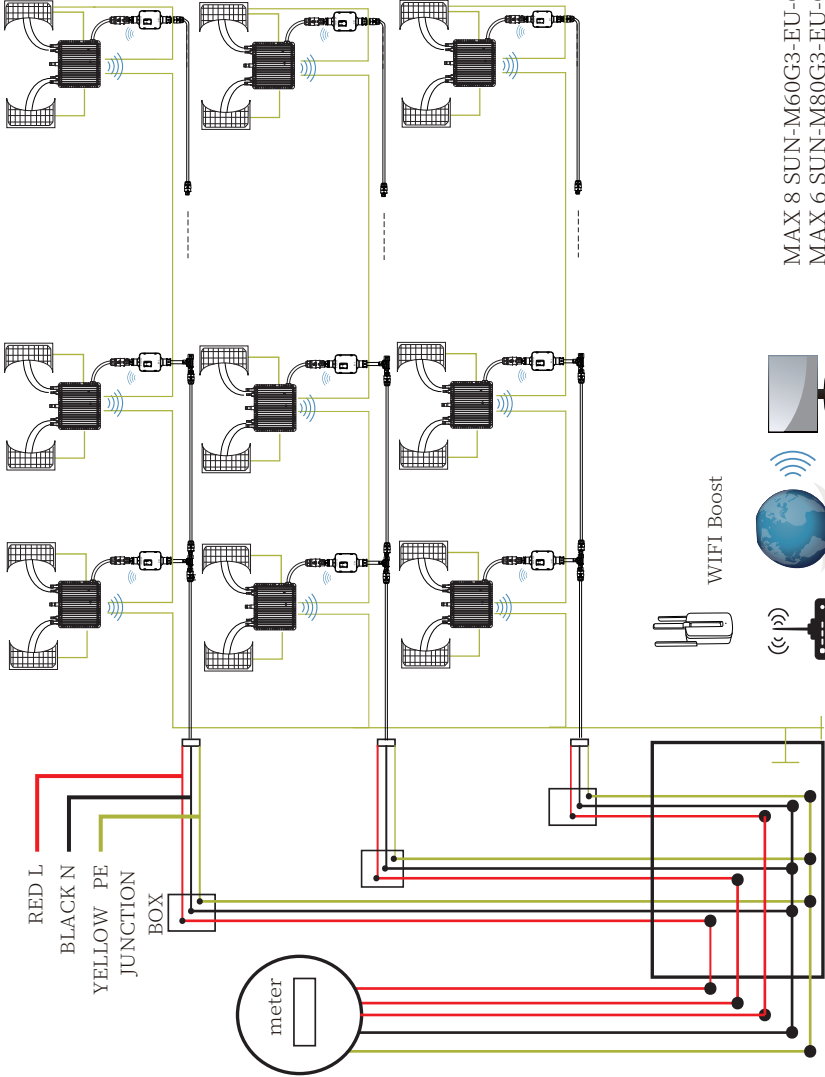

MAX 8 SUN-M60G3-EU-Q0-RE per Branch
 MAX 6 SUN-M80G3-EU-Q0-RE per Branch
 MAX 5 SUN-M100G3-EU-Q0-RE per Branch

GROUND Router Monitoring system

M60G3/80G3/100G3 (2MPPT)

Sample Wiring Diagram Single Phase

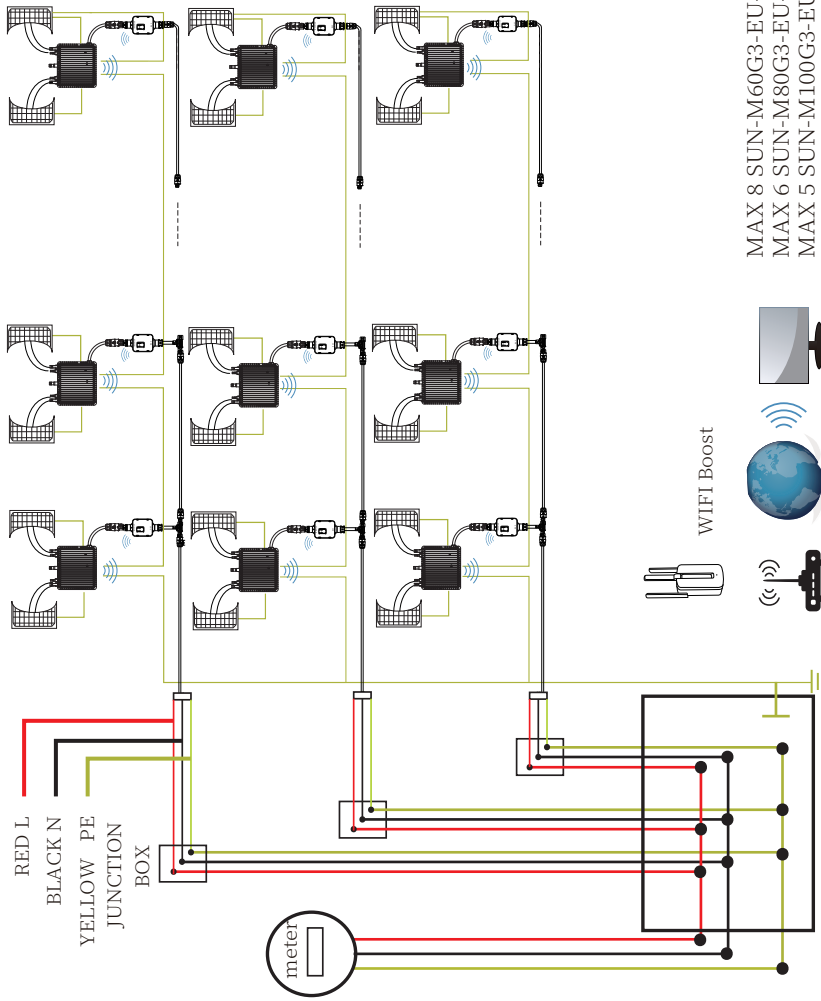

RED L
BLACK N
YELLOW PE
JUNCTION
BOX

meter

WIFI Boost

Router

Monitoring system

MAX 8 SUN-M60G3-EU-Q0-RE per Branch
MAX 6 SUN-M80G3-EU-Q0-RE per Branch
MAX 5 SUN-M100G3-EU-Q0-RE per Branch

How to connect the SUN-MI-RELAY-01 to the Micro Inverterr via web

1. Turn on the wireless network of your PC or smartphone.
2. Select network of SUN-MI-RELAY-01 (network name: RE_3985266017) and the default password of the network is listed on the nameplate of PWD:“5c4db8d6”.

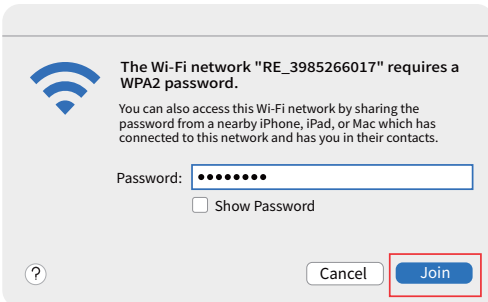

3. Open a browser and enter **10.10.101.254**. Both username and password are "admin". (Recommended browser: IE 8+, Chrome 15+, Firefox 10 +)

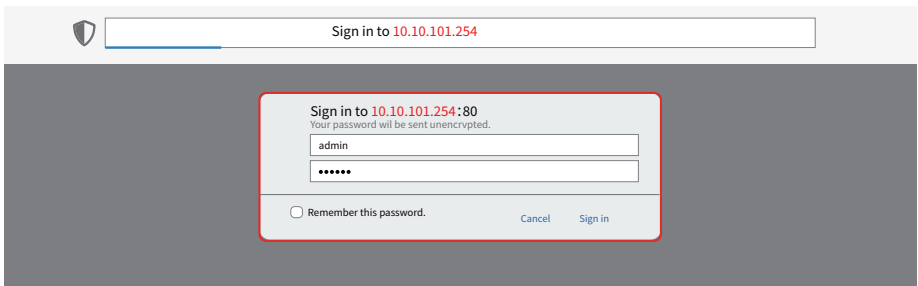

If can't access the 10.10.101.254 for a long while, please disconnect the AC and then waiting for 5S and try again.

4. Browser jumps to “Status” page, the basic information is listed there.

中文 | English

Status	<p>- Inverter information</p> <table border="1" style="width: 100%; border-collapse: collapse;"> <tr><td>Inverter serial number</td><td style="text-align: right;">---</td></tr> <tr><td>Firmware version(main)</td><td style="text-align: right;">---</td></tr> <tr><td>Firmware version(slave)</td><td style="text-align: right;">---</td></tr> <tr><td>Inverter model</td><td style="text-align: right;">---</td></tr> <tr><td>Rated power</td><td style="text-align: right;">--- W</td></tr> <tr><td>Current power</td><td style="text-align: right;">--- W</td></tr> <tr><td>Yield today</td><td style="text-align: right;">--- kWh</td></tr> <tr><td>Current power</td><td style="text-align: right;">--- kWh</td></tr> <tr><td>Alerts</td><td style="text-align: right;">---</td></tr> <tr><td>Last updated</td><td style="text-align: right;">---</td></tr> </table> <p>• Device information</p> <p>• Remote server information</p>	Inverter serial number	---	Firmware version(main)	---	Firmware version(slave)	---	Inverter model	---	Rated power	--- W	Current power	--- W	Yield today	--- kWh	Current power	--- kWh	Alerts	---	Last updated	---
Inverter serial number	---																				
Firmware version(main)	---																				
Firmware version(slave)	---																				
Inverter model	---																				
Rated power	--- W																				
Current power	--- W																				
Yield today	--- kWh																				
Current power	--- kWh																				
Alerts	---																				
Last updated	---																				
Wizard																					
Quick Set																					
Advanced																					
Upgrade																					
Restart																					
Reset																					

Help

The device can be used as a wireless access point(AP mode) to facilitate users to configure the device, or it can also be used as a wireless information terminal (STA mode) to connect the remote server via wireless router.

Status of remote server

- ◆ Not connected: Connection to server failed last time.

If under such status, please check the issues as follows:

- (1) check the device information to see whether IP address is obtained or not;
- (2) check if the router is connected to internet or not;
- (3) check if a firewall is set on the router or not;

Web Ver:1.0.24

5. Click to enter the "Quick Set" page and click the "Search" button to start searching for network hotspots near the NS protection device.

Help

Status	
Wizard	
Quick Set	<p>Network name (SSID) (Note: case sensitive) <input style="width: 150px;" type="text"/> Search</p> <p>Encryption method <input style="width: 100px;" type="text" value="WPA2PSK"/></p> <p>Encryption algorithm <input style="width: 100px;" type="text" value="AES"/></p> <p>Password (8-64 bytes) (Note: case sensitive) <input style="width: 150px;" type="password"/></p> <p>Obtain an IP address automatically <input checked="" type="checkbox"/> Enable</p> <p>IP address <input style="width: 150px;" type="text" value="10.10.100.150"/></p> <p>Subnet mask <input style="width: 150px;" type="text" value="255.255.255.0"/></p> <p>Gateway address <input style="width: 150px;" type="text" value="10.10.100.254"/></p> <p>DNS server address <input style="width: 150px;" type="text"/></p> <p style="text-align: center; font-size: small;">* Note: After clicking Save, the system will restart immediately.</p> <p style="text-align: right; margin-top: 10px;">Save</p>
Advanced	
Upgrade	
Restart	
Reset	

Help

In this page, you can click the "Search" button to automatically search for nearby wireless access point, and connect your device to it by setting the network parameters.

***Note: If you haven't set this kind of device before, please follow the setup wizard.**

***Note: After clicking Save, the system will restart immediately.**

You need to re-login the configuration interface after restart.

6. Click to select your micro-inverter's WLAN hotspot and enter the inverter hotspot password.

The screenshot shows a web interface for WLAN configuration. On the left is a navigation menu with 'Quick Set' selected. The main area is titled 'Please select your current wireless network:'. It contains a 'Site Survey' table with the following data:

SSID	BSSID	RSSI	Channel
AP_3907817077	EC:FD:F8:9A:53:A	100	1

Below the table is a text input field with the placeholder 'Please enter the password!'. A note below the field reads: '* Note: When connector, shorten the distance between the device and router.' There is a 'close' button next to the note. At the bottom are 'OK' and 'Refresh' buttons.

On the right side, there is a 'Help' section with the text: 'Please refresh repeatedly if there is no desirable wireless access point available'. At the top right, there are language options '中文 | English'.

7. The default password of the AP network is 12345678 if there's no nameplate that includes PWD:XXXXXXXX on the inverter body. If there's nameplate that includes PWD:XXXXXXXX on the inverter body then the AP network password is the "XXXXXXXX".

The screenshot shows the 'Quick Set' configuration page. The left navigation menu has 'Quick Set' selected. The main area contains the following fields:

- Network name (SSID) (Note: case sensitive): AP_3907817077
- Encryption method: WPA2PSK
- Encryption algorithm: AES
- Password (8-64 bytes) (Note: case sensitive): [Redacted]
- Obtain an IP address automatically: Enable
- IP address: 10.10.100.150
- Subnet mask: 255.255.255.0
- Gateway address: 10.10.100.254
- DNS server address: 68.241.0.66

At the bottom, there is a note: '* Note: After clicking Save, the system will restart immediately.' and a 'Save' button.

On the right side, the 'Help' section contains the following text: 'In this page, you can click the "Search" button to automatically search for nearby wireless access point, and connect your device to it by setting the network parameters. *Note: If you haven't set this kind of device before, please follow the setup wizard. *Note: After clicking Save, the system will restart immediately. You need to re-login the configuration interface after restart.'

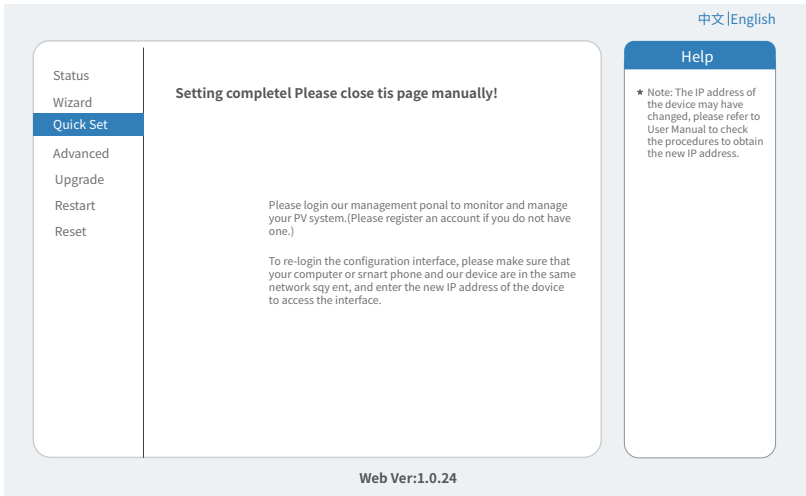

8. Click to enter the Status page, You can view the current connection information on the Device information page. If you need help, Please contact Deye's official after-sales service or authorized service provider.

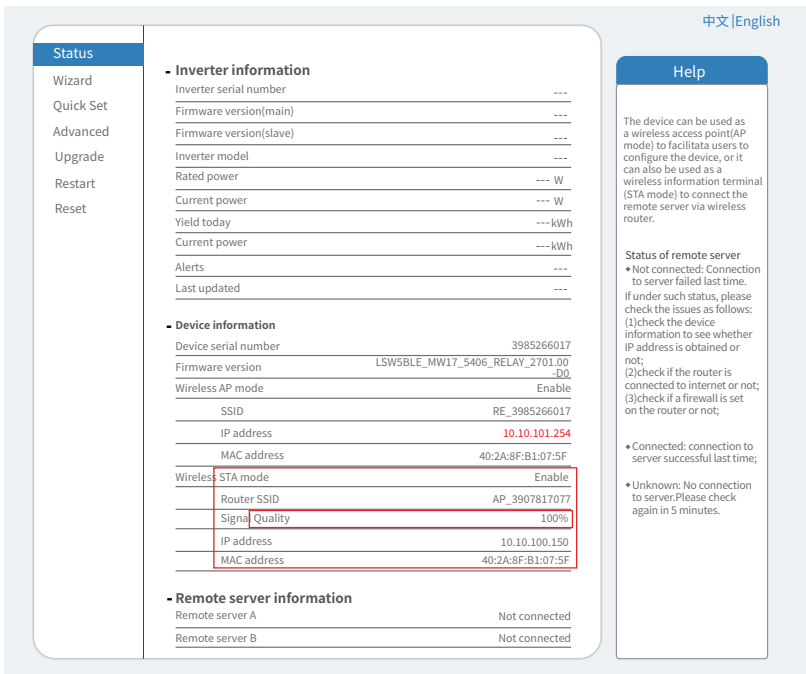

How to connect the Micro Inverter to the router via web

1. Turn on the wireless network of your PC or smartphone.
2. The default password of the AP network is 12345678 if there's no nameplate that includes PWD:XXXXXXXX on the inverter body. If there's nameplate that includes PWD:XXXXXXXX on the inverter body then the AP network password is the "XXXXXX XXX": for example, the default password of AP network is "5c4db4d8" of the inverter SN:2302202012.

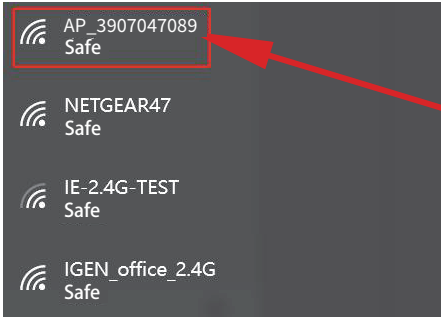

Micro Inverter SN: 2302202012 Built-in datalogger :3907047089

Also, the default password can be changed. If forgetting the modified password, please contact service@deye.com.cn for help.

3. Open a browser and enter **10.10.100.254**. Both username and password are "admin". (Recommended browser: IE 8+, Chrome 15+, Firefox 10 +).

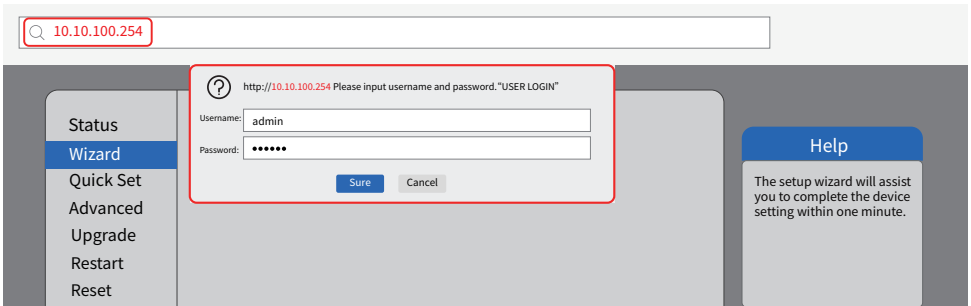

4. Browser jumps to "Status" page, the basic information is listed there.

Status

Wizard

Quick Set

Advanced

Upgrade

Restart

Reset

- Inverter information

Inverter serial number	---
Firmware version(main)	---
Firmware version(slave)	---
Inverter model	---
Rated power	--- W
Current power	--- W
Yield today	---kWh
Current power	---kWh

- Device information

Device serial number	3907047089
Firmware version	LSW3_14_FFFF_1.0.23
Wireless AP mode	Enable
SSID	AP_1704013242
IP address	10.10.100.254
MAC address	8C:D8:B3:71:8D:B0
Wireless STA mode	Disable
Router SSID	
Signal Quality	
IP address	
MAC address	

- Remote server information

Remote server A	Not connected
Remote server B	Not connected

Help

The device can be used as a wireless access point(AP mode) to facilitate users to configure the device, or it can also be used as a wireless information terminal (STA mode) to connect the remote server via wireless router.

Status of remote server

- Not connected: Connection to server failed last time. If under such status, please check the issues as follows: (1)check the device information to see whether IP address is obtained or not; (2)check if the router is connected to internet or not; (3)check if a firewall is set on the router or not;
- Connected: connection to server successful last time;
- Unknown: No connection to server.Please check again in 5 minutes.

5. Turn to "Wizard" page, click "Refresh" to search the wireless network. Select the target network and click "Next" .

Status

Wizard

Quick Set

Advanced

Upgrade

Restart

Reset

Please select your current wireless network:

<input checked="" type="radio"/> IE-2.4G-TEST	54:A7:3:70:99:13	82	1
<input type="radio"/> AP_1753738492	0:BE:D5:20:B8:2C	80	1
<input type="radio"/> IGEN_office_2.4G	0:BE:D5:20:B8:2C	78	2
<input type="radio"/> IGENTEST	E8:65:D4:F2:15:68	74	6
<input type="radio"/> IGEN_office_2.4G	90:5D:7C:97:95:29	74	1
<input type="radio"/> IGEN_office_2.4G	90:5D:7C:97:95:27	72	1
<input type="radio"/> IGEN_office_2.4G	90:5D:7C:97:C9:E5	72	1
<input type="radio"/> AP_1719065936	30:EA:E7:36:CF:B2	70	1
<input type="radio"/> IGEN_office_2.4G	90:5D:7C:97:C9:E3	70	1
<input type="radio"/> TESR+™ ?=, ;	4A:E:EC:9E:C3:3E	70	11
<input type="radio"/> IGEN_office_2.4G	0:BE:D5:20:B7:EE	66	11

* Note: When RSSI of the selected WiFi network is lower than 15%, the connection may be unstable, please select other available network or shorten the distance between the device and router.

Refresh

Add wireless network manually:

Network name (SSID)
(Note:case sensitive)

Encryption method

Encryption algorithm

Next

1
2
3
4

Help

The setup wizard will assist you to complete the device setting within one minute.

6. Enter the password and click Next.

Status

Wizard

Quick Set

Advanced

Upgrade

Restart

Reset

Please fill in the following information:

Password(8-64 bytes)
(Note: case sensitive)

Show Password

Obtain an IP address automatically

IP address

Subnet mask

Gateway address

DNS server address

1 2 3 4

Help

Most systems support the function of DHCP to obtain IP address automatically. Please select disable and add it manually if your router does not support such function.

7. Users can select any options below to enhance the security and click Next.

Status

Wizard

Quick Set

Advanced

Upgrade

Restart

Reset

Enhance Security

You can enhance your system security by choosing the following methods

Hide AP

Change the encryption mode for AP

Change the user name and password for Web server

1 2 3 4

Help

Change the encryption mode for AP
If you set password for the AP network, you will need to enter the password to connect to AP.

Change the user name and password for Web server
If you change the username and password for the web server, you will need to enter the new username and password to get access to the setting page.

8. If the setup is successful, the following page will pop up and click OK to reboot the micro inverter.

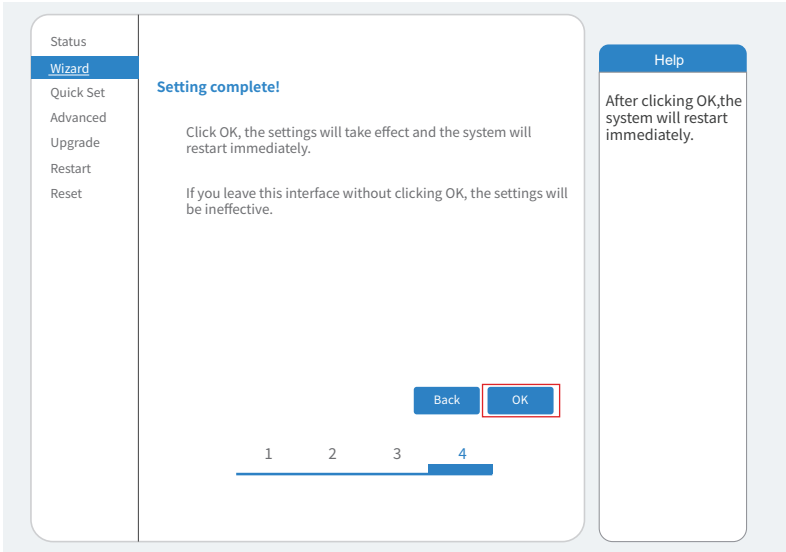

9. Connect to logger AP network again, then log in to 10.10.101.254 by Browser, and check the system info of "Status" page. After the network setting is done, the remote server A or B should be "connected".

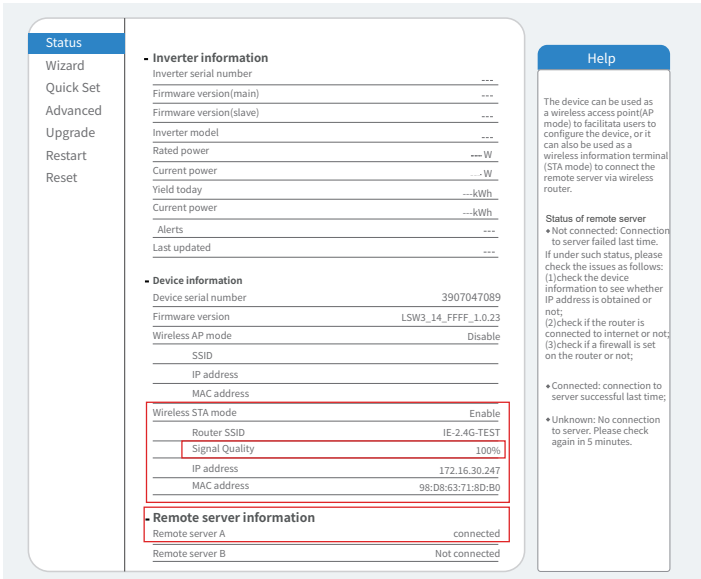

10. When it shows "connected" which means this Micro Inverter has connected solarman platform successfully. Generally speaking, it will be online after 10-15min after configuration successfully at the first time.

How to connect in APP

1. Registration

Open the app of SOLARMAN Smart and register an account.
Click "Register" and create your account here.

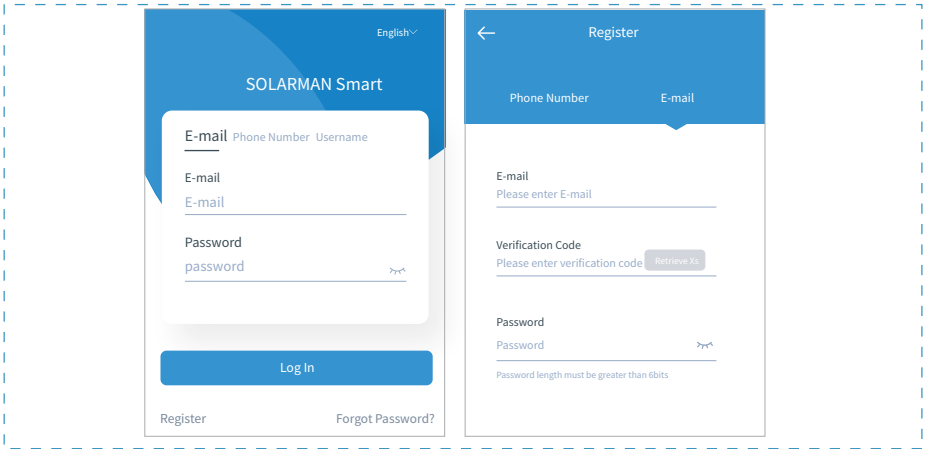

2. Create a Plant

Click "Add Now" to create your plant.
Please fill in plant basic info and other info here.

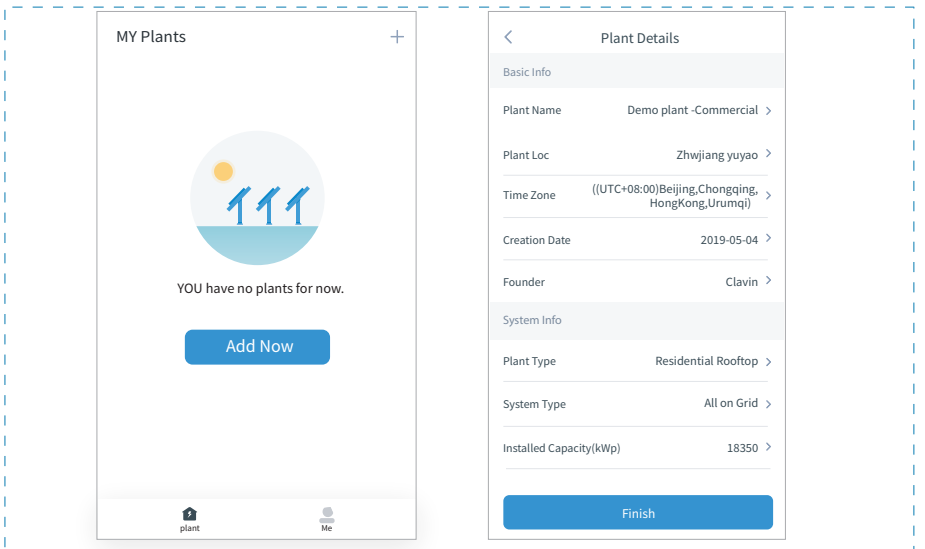

3. Add a Logger

Optional 1: Enter the logger SN manually.

Optional 2: Click the icon in the right and scan the QR code to enter logger SN.

You can find logger SN on the carton packaging or on the logger body.

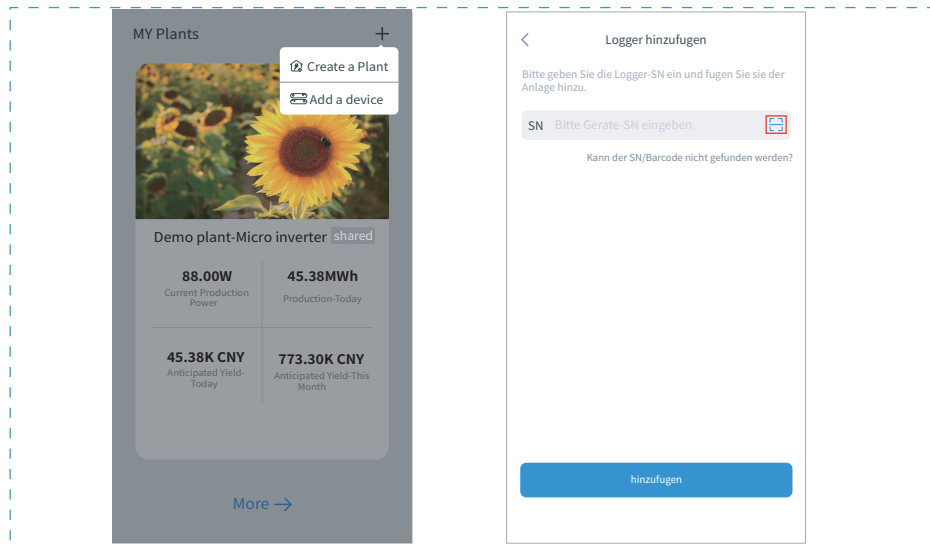

4. Network Configuration

After the logger is added, please configure the network to ensure normal operation.

Go to "Plant Details"->"Device List", find the target SN and click " Device Networking".

If showing "online" which means the datalogger of the inverter connects the solarman platform successfully. Then you will be able to check the plant info on the platform.

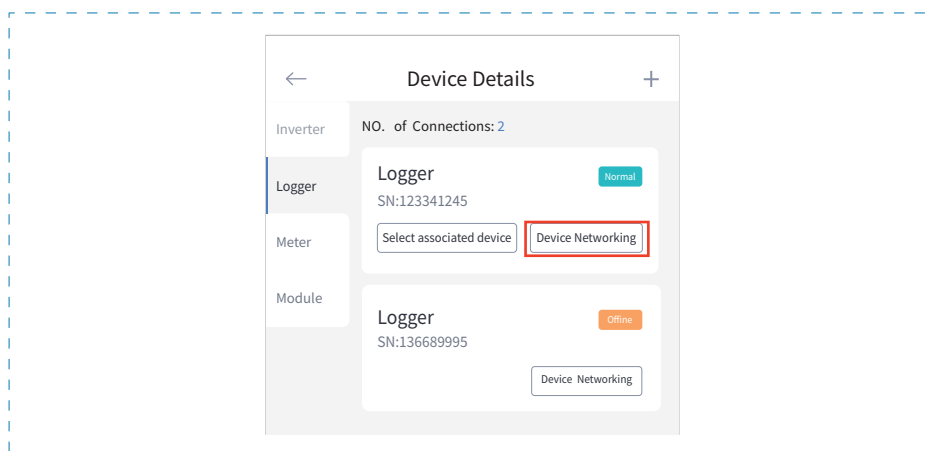

EU Declaration of Conformity

within the scope of the EU directives

- Radio Equipment Directive 2014/53/EU (RED)
- Restriction of the use of certain hazardous substances 2011/65/EU (RoHS)



NINGBO DEYE INVERTER TECHNOLOGY CO.,LTD confirms herewith that the products described in this document are in compliance with the fundamental requirements and other relevant provisions of the above mentioned directives. The entire EU Declaration of Conformity can be found at www.deyeinverter.com.



30240301002136