



Vorläufige Prototypenbescheinigung / Preliminary Prototype Confirmation

Hersteller / Antragsteller
Manufacturer / Applicant:

Huawei Technologies Co., Ltd.
Administration Building, Headquarters of Huawei Technologies Co., Ltd. Bantian,
Longgang District, Shenzhen, Guangdong, 518192, China

Produkttyp / Product type:

Netzgebundener Photovoltaikwechselrichter /
Grid-tied photovoltaic (PV) inverter

Modelle / Models:	SUN2000-50KTL-M3		
Technische Daten / Specifications:	Nennscheinleistung / <i>Nominal apparent power:</i>	50 kVA	
	Nennwirkleistung / <i>Nominal active power:</i>	50 kW	
	Nennspannung / <i>Nominal voltage:</i>	400V	480V
	Nennfrequenz / <i>Nominal frequency:</i>	50 Hz	

Beschreibung / Description: Leistungselektronischer Umrichter zur Einspeisung von DC-Strom aus Photovoltaik-Modulen ins öffentliche Stromnetz / *Power electronic inverter for injection of direct current generated by means of photovoltaic panels into the public AC grid*

Standards / Standards: **VDE-AR-N 4110:2018-11** – Technische Regeln für den Anschluss von Kundenanlagen an das Mittelspannungsnetz und deren Betrieb (TAR Mittelspannung) / *Technical requirements for the connection and operation of customer installations to the medium voltage network (TAR medium voltage)*

VDE AR-N 4120:2018-11 – Technische Regeln für den Anschluss von Kundenanlagen an das Hochspannungsnetz und deren Betrieb (TAR Hochspannung) / *Technical requirements for the connection and operation of customer installations to the high voltage network (TCR high voltage)*

FGW TR8 / TG8 Rev. 9 (2019-02-01) – Zertifizierung der elektrischen Eigenschaften von Erzeugungseinheiten und -anlagen, Speicher sowie für deren Komponenten am Stromnetz / *Certification of the Electrical Characteristics of Power Generating Units, Systems and Storage Systems as well as their Components on the Grid*

Diese vorläufige Prototypenbescheinigung bestätigt, dass es sich bei den genannten Erzeugungseinheiten (EZE) nach VDE-AR-N 4110 und VDE-AR-N 4120 sowie gemäß FGW TR 8 um Prototypen handelt: Die EZE weisen wesentliche technische Weiterentwicklungen oder Neuerungen auf (siehe Anhang 3). / *This preliminary prototype certificate confirms that the above-mentioned PGUs are prototypes according to VDE-AR-N 4110 / VDE-AR-N 4120 and FGW TG 8: The PGUs are characterized by major technical developments or innovations (see Annex 3).*

Weiterhin bestätigt diese Prototypenbescheinigung, dass die genannten EZE in der Lage sind, die Anforderungen an die elektrischen Eigenschaften der EZE nach VDE-AR-N 4110 und VDE-AR-N 4120 zu erfüllen (siehe Anhang 5). Es wird davon ausgegangen, dass die Anforderungen in Anhang A.1 und Anhang A.2 der FGW TR8 im Rahmen einer Zertifizierung erfüllt werden. / *This prototype certificate also confirms the general ability of the PGUs to fulfil the requirements of the VDE-AR-N 4110 / VDE-AR-N 4120, based on manufacturer data of the electrical properties of the PGUs (see Annex 5). It is expected that in the scope of a certification the requirements of Annex A.1 and Annex A.2 of the FGW TG8 will be fulfilled.*

Anmerkung: Eine Prüfklemmleiste ist bei Bedarf separat nachzurüsten. / *Note: A test terminal strip has to be installed separately if necessary.*

Erstinbetriebnahmedatum der EZE in Deutschland / *Commission of the first power generating unit prototype in Germany:* **Erstinbetriebnahmedatum nicht festgelegt /** *Date of commission not confirmed:*

Projektnummer / *Project number:* **23TH0196** **Zertifizierungsprogramm** */ Certification scheme:* **NSOP-0032-DEU-ZE-V01**

Dokumentnummer / *document number:* **U23-0050** **Ausstellungsdatum /** *Date of issue:* **2023-02-01**



Zertifizierungsstelle der Bureau Veritas Consumer Products Services Germany GmbH Akkreditiert nach DIN EN ISO/IEC 17065
Eine auszugsweise Darstellung des Zertifikats bedarf der schriftlichen Genehmigung der Bureau Veritas Consumer Products Services Germany GmbH

**Beschreibung der Revisionierung der vorläufigen Prototypenbestätigung U23-0050/
Description of the revisioning of preliminary prototype confirmation U23-0050**

Rev. 0	Erstausstellung / <i>First issue</i>
--------	--------------------------------------

Anhang 1 / Annex 1

Diese Bescheinigung bestätigt, dass es sich bei den genannten Erzeugungseinheiten (EZE) nach FGW TR 8 um Prototypen handelt. Dazu werden im Folgenden die EZE beschrieben und die wesentlichen technischen Weiterentwicklungen oder Neuerungen dargestellt. /

This certificate confirms that the mentioned power generating unit (PGU) according to FGW TR 8 is a prototype. For this purpose, the PGU is described below, and the main technical developments or innovations are presented.

Nach Inbetriebnahme der ersten Einheit des genannten Typs ist der Zertifizierungsstelle das Inbetriebnahmedatum mitzuteilen. Daraufhin wird die vorläufige Prototypenbestätigung durch eine Prototypenbestätigung ersetzt, die eine Gültigkeit von 2 Jahren nach mitgeteiltem Inbetriebnahmedatum aufweist. Danach muss für die Einheit ein gültiges Einheitenzertifikat vorliegen. /

After commissioning the first unit of the specified type, the certification body must be notified of the commissioning date. The preliminary prototype confirmation is then replaced by a prototype confirmation, which is valid for 2 years after the notified commissioning date. After that, the unit must have a valid unit certificate. /

FGW TR 8 (Revision 9)

Anforderungen / <i>Requirements</i>	Kommentar / <i>Bewertung</i> Comment / <i>Verdict</i>
-------------------------------------	--

2.11 Betriebsmittelprototypen / *Equipment prototypes*

2.11.1 Prototypenregelung / *Prototype regulation*

Ein Prototyp ist das erste Betriebsmittel eines Typs, welches wesentliche technische Weiterentwicklung oder Neuerung aufweist, sowie alle weiteren Betriebsmittel dieses Typs, die innerhalb von zwei Jahren nach Inbetriebsetzung des ersten Betriebsmittels dieses Typs in Betrieb gesetzt werden. /

A prototype is the first piece of equipment of a type displaying fundamental technical developments or innovations, and all additional pieces of equipment of this type commissioned within two years of commissioning the first piece of equipment of this type.

Die Regelung und Fristen von Betriebsmittelprototypen in einer EZA können der NAR entnommen werden. /

The regulation and periods for equipment prototypes in a PGS can be found in the GCR.

Berücksichtigt (Anhang 3) / *Considered (Annex 3).*

Berücksichtigt.
gemäß VDE-AR-N 4110: 2018-11 und VDE-AR-N 4120: 2018-11 gilt:
für Erzeugungsanlagen mit Erzeugungseinheiten gleichen Prototyps müssen das Anlagenzertifikat und die Konformitätserklärung binnen eines Jahres, nachdem für den ersten Prototypen ein Einheitenzertifikat vorliegt, nachgereicht werden. /
Considered.

according to VDE-AR-N 4110: 2018-11 and VDE-AR-N 4120: 2018-11 applies: for production plants with production units of the same prototype, the plant certificate and the declaration of conformity must be submitted within one year after the first prototype has received a unit certificate.

Anhang 1 / Annex 1

2.11.2 Prototypenbestätigung

Voraussetzung für das Ausstellen einer Prototypenbestätigung durch eine Zertifizierungsstelle ist eine Herstellererklärung zu folgenden Punkten: /

The prerequisite for a certification body issuing a prototype confirmation is a manufacturer's declaration regarding the following points :

- Erklärung der teilweisen oder vollständigen Konformität zu einer oder mehreren NAR / *statement on the partial or complete conformity with one or more GCR;*
- Erklärung, dass es sich um eine wesentliche technische Weiterentwicklung bzw. Neuerung handelt / *declaration that this relates to a substantial technical development or innovation;*

Berücksichtigt (siehe Anhang 7 /
Considered (see Annex 7).

Berücksichtigt (Anhang 3) /
Considered (Annex 3).

- Aufzeigen von Unterschieden zu ggf. vorhandenen und bereits zertifizierten Betriebsmitteln / *the identification of differences to any existing and previously certified equipment;*

Berücksichtigt (Anhang 3) /
Considered (Annex 3).

- Weitere technische Daten entsprechend den Anforderungen der jeweiligen NAR / *additional technical data corresponding to the requirements or the relevant GCR.*

Berücksichtigt (siehe Anhang 5) . /
Considered (see Annex 5).

Wesentliche technische Weiterentwicklungen und Neuerungen liegen in der Regel vor, wenn Komponenten oder Softwareversionen so geändert werden, dass sich das elektrische Verhalten der Betriebsmittel am Netz signifikant ändert oder dass ein äquivalentes elektrisches Verhalten durch eine andere technische Weiterentwicklung und Neuerung erreicht wird. /

Substantial technical developments and innovations are usually present if components or software versions have been modified such that the electrical behaviour of the generation unit on the grid has significantly changed or an equivalent electrical behaviour has been achieved through a different technical development and innovation.

Da mit dem Produkt die Einheitszertifizierung nach VDE-AR- N 4110 und -4120 angestrebt wird und bisher noch keine Zertifizierung erfolgt ist, handelt es sich bei der eingesetzten Softwareversion um eine wesentliche technische Weiterentwicklung/ Neuerung.

Since the product is intended to achieve unit certification in accordance with VDE-AR- N 4110 and -4120 and no certification has yet been obtained, the software version used is a significant technical development/innovation.

Auf Basis der vorgelegten Herstellererklärungen zum Prototyp bewertet die Zertifizierungsstelle, ob es sich um eine technische Weiterentwicklung handelt und bescheinigt dies in Form einer Prototypenbestätigung. /

Based on the manufacturer's declarations submitted regarding the prototype, the certification body will assess whether this is a technical development and certifies this in the form of a prototype confirmation

Berücksichtigt (siehe Anhang 3). /
Considered (see Annex 3).

Die Zertifizierungsstelle muss in der Prototypenbestätigung nachvollziehbar ausweisen, dass der Prototyp grundsätzlich in der Lage wäre, die Anforderungen der jeweiligen NAR an die elektrischen Eigenschaften und Funktionen der Betriebsmittel zu erfüllen. Die Vorgaben der NAR an den Prüfumfang für die Prototypenbestätigung sind zu berücksichtigen (sofern vorhanden). /

The certification body must clearly identify in the prototype confirmation that the prototype would fundamentally be able to meet the requirements of the relevant GCR in terms of electrical characteristics and functions of the operating equipment. The requirements of the GCR for the test scope for the prototype confirmation must be taken into account (to the extent present).

Berücksichtigt (siehe Anhang 3). /
Considered (see Annex 3).

Anhang 2 / Annex 2

Diese Bescheinigung bestätigt, dass die genannten Erzeugungseinheiten (EZE) in der Lage sind, die Anforderungen an die elektrischen Eigenschaften der Erzeugungseinheit nach VDE-AR-N 4110 und -4120 zu erfüllen. Dazu wird im Folgenden die Übereinstimmung der elektrischen Eigenschaften der EZE mit den Anforderungen nach VDE-AR-N 4110 und -4120 nachgewiesen: /

This certificate confirms that the named generating unit (PGU) is able to meet the requirements for the electrical properties of a generating unit according to VDE-AR-N 4110 and -4120. For this purpose, the conformity of the electrical properties of the PGU with the requirements of the VDE-AR-N 4110 and -4120 is verified as described below:

Art der Betriebsmittel / Type of equipment:	EZE / PGU			Komponenten / component		
	PV	Speicher / Storage	ORC	EZA-Regler / plant controller	Kompensations- einrichtungen / compensation circuits	Schutz- einrichtungen / Interface protection
	<input checked="" type="checkbox"/>	<input type="checkbox"/>	<input type="checkbox"/>	<input type="checkbox"/>	<input type="checkbox"/>	<input type="checkbox"/>
Anmerkung / Note:	Die folgenden Punkte 1), 2) und 4) sind anzuwenden / <i>The following points 1), 2) and 4) are to be applied</i>			Die folgenden Punkte 1), 2), 3) und 4) sind anzuwenden / <i>The following points 1), 2), 3) and 4) are to be applied</i>		

VDE-AR-N 4110

BV-Nr / BV No.	Anforderungen / Requirements	Kommentar / Bewertung Comment / Verdict
12 Prototypenregelung / Regulation for prototypes		
1)	<p>Ein Prototyp ist die erste Erzeugungseinheit eines Typs, der wesentliche technische Weiterentwicklungen oder Neuerungen aufweist, und alle weiteren Erzeugungseinheiten dieses Typs, die innerhalb von zwei Jahren nach der Inbetriebsetzung der ersten Erzeugungseinheit dieses Typs in Betrieb gesetzt werden.</p> <p>ANMERKUNG 1 Diese Definition entspricht der Begriffsdefinition nach SDLWindV [1]. Es besteht kein Zusammenhang zum Begriff „Pilotwindenergieanlage“ im EEG [6].</p> <p>Wesentliche technische Weiterentwicklungen und Neuerungen liegen in der Regel vor, wenn Komponenten oder Softwareversionen so geändert werden, dass sich das elektrische Verhalten der Erzeugungseinheit am Netz signifikant ändert und eine Einheitszertifizierung dieses neuen Typs erforderlich wird. /</p> <p><i>A prototype is the first power generating unit of a type presenting substantial technological developments or innovations and all other power generating units of this type put into operation within two years after the commissioning of the first power generating unit of this type.</i></p> <p>NOTE 1 This definition corresponds to the term's definition given in SDLWindV [1]. There is no relation to the term "pilot wind turbine" (de: Pilotwindenergieanlage) used in the EEG [6].</p> <p><i>Technological developments and innovations are generally considered to be substantial where components or software versions are changed so that the electrical behaviour of the power generating unit at the network changes significantly and a unit certification of this new type is required.</i></p>	Berücksichtigt (Anhang 3) / <i>Considered (Annex 3).</i>

Anhang 2 / Annex 2

BV-Nr / BV No.	Anforderungen / Requirements	Kommentar / Bewertung Comment / Verdict
2)	<p>Für einen Prototypen einer Erzeugungseinheit gelten die Anforderungen dieser VDE-Anwendungsregel. Innerhalb von zwei Jahren nach der Inbetriebsetzung der ersten Prototypen-Erzeugungseinheit in Deutschland ist für diese Prototypen anstelle des Einheitenzertifikats eine Prototypenbestätigung ausreichend, in der die Zertifizierungsstelle das Vorhandensein einer wesentlichen technischen Weiterentwicklung oder Neuerung auf Basis einer Herstellererklärung bestätigt. Weiterhin ist durch die Zertifizierungsstelle zu prüfen und in der Prototypenbestätigung nachvollziehbar auszuweisen, ob der Prototyp grundsätzlich in der Lage ist, die Anforderungen dieser VDE-Anwendungsregel an die elektrischen Eigenschaften der Erzeugungseinheit zu erfüllen. Dies erfolgt auf Basis eines vom Hersteller der Erzeugungseinheit erstellten Datenblattes der elektrischen Eigenschaften.</p> <p>Für Prototypen die vor dem 27.04.2019 in Betrieb gesetzt werden, beginnt die oben genannte Frist am 27.04.2019. /</p> <p><i>For the prototype of a power generating unit the requirements of this VDE application guide apply. For these prototypes, a prototype confirmation, in which the certification body confirms a substantial technological development or innovation based on a manufacturer declaration, is sufficient, instead of the unit certificate, for a period of two years after commissioning of the first power generating unit prototype in Germany. The certification body shall also check and set out reproducibly in the prototype confirmation, whether the prototype is generally capable of meeting the requirements of this VDE application guide for the electrical properties of the power generating unit. This is based on an electrical properties data sheet prepared by the manufacturer of the power generating unit.</i></p> <p><i>For prototypes commissioned before 2019-04-27, the above-mentioned period starts 2019-04-27.</i></p>	<p>Berücksichtigt. / <i>Considered.</i></p>
3)	<p>Für Komponenten innerhalb der Erzeugungsanlage, für die ein Komponentenzertifikat erforderlich ist, kann die Prototypenregelung entsprechend angewendet werden. /</p> <p><i>For components within the power generating plant, for which a component certificate is required, the prototype regulation can be applied in analogy.</i></p>	<p>Entfällt. / <i>Not applicable.</i></p>

Anhang 2 / Annex 2

BV-Nr / BV No.	Anforderungen / Requirements	Kommentar / Bewertung Comment / Verdict
4)	<p>Damit die geforderte Plausibilitätsprüfung durch die Zertifizierungsstelle erfolgen kann, muss das Datenblatt der Erzeugungseinheit mindestens folgende Angaben enthalten:</p> <ul style="list-style-type: none"> - elektrische Daten (Nenn- und Bemessungsgrößen) - schematisches Übersichtsbild der Erzeugungseinheit mit allen wesentlichen Komponenten - Betriebsbereiche der Erzeugungseinheit: <ul style="list-style-type: none"> • Grenzen im quasistationären Betrieb • Blindleistungsstellbereich • FRT-Grenzkurve(U/t-Diagramm) - Schutzfunktionen mit Einstellbereichen: <ul style="list-style-type: none"> • Entkopplungsschutz • Eigenschutz - Wirkleistungsregelung: <ul style="list-style-type: none"> • Leistungs-Frequenz-Verhalten • Wirkleistungsgradient - Blindleistungsregelung - Dynamische Blindstromspeisung: <ul style="list-style-type: none"> • Grundsätzliche Funktionsweise - Erklärung des Herstellers, dass die Erzeugungseinheit so konstruiert wurde, dass die Anforderungen dieser Anwendungsregel an die Erzeugungseinheit erfüllt werden können. <p>Spätestens nach Ablauf der oben genannten Frist ist ein Einheitenzertifikat erforderlich</p> <p>ANMERKUNG 2 Sofern das Einheitenzertifikat vor Ablauf der Frist von zwei Jahren nach der Inbetriebsetzung der ersten Erzeugungseinheit dieses Typs vorliegt, kann es sich dennoch um einen Prototypen handeln. /</p> <p><i>In order to allow the certification body to carry out the required plausibility test, the data sheet of the power generating unit shall contain at least the following information:</i></p> <ul style="list-style-type: none"> - <i>electrical data (nominal and rated quantities);</i> - <i>schematic overview circuit diagram of the power generating unit with all relevant components;</i> - <i>operating ranges of the power generating unit:</i> <ul style="list-style-type: none"> • <i>limits in quasi-steady-state operation,</i> • <i>reactive power adjustment range,</i> • <i>FRT limit curve (U/t diagram);</i> - <i>protection functions with setting ranges:</i> <ul style="list-style-type: none"> • <i>decoupling protection,</i> • <i>self-protection;</i> - <i>active power control:</i> <ul style="list-style-type: none"> • <i>power/frequency behaviour,</i> • <i>active power gradient;</i> - <i>reactive power control:</i> - <i>dynamic reactive current feed-in:</i> <ul style="list-style-type: none"> • <i>basic functionality;</i> - <i>declaration of the manufacturer stating that the power generating unit has been designed so that the requirements of this application guide for the power generating unit can be complied with</i> <p><i>At the latest after expiry of the above-mentioned period, a unit certificate is required.</i></p> <p><i>NOTE 2 If the unit certificate is available prior to expiry of the two-year term after commissioning the first power generating unit of this type, it can still be a prototype.</i></p>	<p>Berücksichtigt. Daten vom Hersteller stehen zur Verfügung (siehe Anhang 3 bis Anhang 6). Ergebnisse der Plausibilitätsprüfung siehe folgende Tabelle.</p> <p><i>Considered. Data from the manufacturer are available (see Annex 3 till Annex 6). Results of the plausibility check see the following table. The electrical behaviour of the system relating to the connection point is provided by the grid-tied inverter.</i></p>

Anhang 2 / Annex 2

Plausibilitätsprüfung / Plausibility test

a)	Elektrische Daten (Nenn- und Bemessungsgrößen) / <i>electrical data (nominal and rated quantities)</i>	Erfüllt (, Anhang 4) / <i>Fulfilled (Annex 4)</i>
b)	Schematisches Übersichtsbild der Erzeugungseinheit mit allen wesentlichen Komponenten; / <i>schematic overview circuit diagram of the power generating unit with all relevant components;</i>	Erfüllt (siehe Anhang 5) / <i>Fulfilled (see Annex 5)</i>
c)	Betriebsbereiche der Erzeugungseinheit: <ul style="list-style-type: none"> • Grenzen im quasistationären Betrieb • Blindleistungsstellbereich • FRT-Grenzkurve(U/t-Diagramm) / <i>operating ranges of the power generating unit:</i> <ul style="list-style-type: none"> • <i>limits in quasi-steady-state operation,</i> • <i>reactive power adjustment range,</i> • <i>FRT limit curve (U/t diagram);</i> 	Erfüllt (siehe Anhang 5) / <i>Fulfilled (see Annex 5)</i>
d)	Schutzfunktionen mit Einstellbereichen: <ul style="list-style-type: none"> • Entkopplungsschutz • Eigenschutz / <i>protection functions with setting ranges:</i> <ul style="list-style-type: none"> • <i>decoupling protection,</i> • <i>self-protection</i> 	Erfüllt (siehe Anhang 6) / <i>Fulfilled (see Annex 6)</i>
e)	Wirkleistungsregelung: <ul style="list-style-type: none"> • Leistungs-Frequenz-Verhalten • Wirkleistungsgradient / <i>active power control:</i> <ul style="list-style-type: none"> • <i>power/frequency behaviour,</i> • <i>active power gradient;</i> 	Erfüllt (siehe Anhang 5 , Anhang 6) / <i>Fulfilled (see Annex 5, Annex 6)</i>
f)	Blindleistungsregelung; / <i>Reactive power control</i>	Erfüllt (siehe Anhang 5 , Anhang 6) / <i>Fulfilled (see Annex 5, Annex 6)</i>
g)	Dynamische Blindstromeinspeisung: <ul style="list-style-type: none"> • Grundsätzliche Funktionsweise / <i>dynamic reactive current feed-in:</i> <ul style="list-style-type: none"> • <i>basic functionality</i> 	Erfüllt (siehe Anhang 5 , Anhang 6) / <i>Fulfilled (see Annex 5, Annex 6)</i>
h)	Erklärung des Herstellers, dass die Erzeugungseinheit so konstruiert wurde, dass die Anforderungen dieser Anwendungsregel an die Erzeugungseinheit erfüllt werden können. / <i>declaration of the manufacturer stating that the power generating unit has been designed so that the requirements of this application guide for the power generating unit can be complied with</i>	Berücksichtigt (siehe Anhang 7 / <i>Considered (see Annex 7).</i>

Anhang 3 / Annex 3

Herstellereklärung zum Prototyp / Manufacturer's declaration for prototype:



HUAWEI Huawei Technologies Co., Ltd.

Version: V1.0

Manufacturer declaration

Date	Revised Revision	Description	Author
2023.01.23	V1.0	Released	Zhenyuanwei 00608128

1. SUN2000-50KTL inverter(including SUN2000-50KTL-M3) are new platform for high power string inverters. Comparing with SUN2000-40KTL series inverter (including SUN2000-40KTL-M3, SUN2000-36KTL-M3, SUN2000-30KTL-M3) , innovations of new platform as following:

Maximum output power is increased to 50kW: The boost and inverter topology is same as 40KTL. But IGBTs and filters are new designed for high out power. Outer fans are used for cooling system, different from 40KTL(natrue cooling).

2. We has developed and implemented a new firmware (FW version V200R023) and hardware to meet the VDE-AR-N 4110: 2018-11 and VDE-AR-N 4120: 2018-11 requirements in the following models:

- SUN2000-50KTL-M3

Huawei Technologies Co., Ltd.

Shanghai

23 Janu 2023

Place

date

608128 甄元伟

Technical manage(stamp,signature)

Anhang 4 / Annex 4

Elektrische Daten / Electrical data:

Datenblatt der Photovoltaikerzeugungseinheit (PV-EZE) / Specifications of the photovoltaic unit (PV-PGU): SUN2000-50KTL-M3

Herstellerbescheinigung zu spezifischen Daten eines Photovoltaik-Wechselrichters vom Typ SUN2000-50KTL-M3 Manufacturer's certificate on specific data of a Photovoltaic Converter of the type SUN2000-50KTL-M3		
Datum / Date: 2023-01-16		Seite/Page 1/2
1 Allgemeines und Ausgangsgrößen		
General and Output values		
1 Hersteller	HUAWEI TECHNOLOGIES CO.,LTD.	manufacturer
2 Typenbezeichnung	SUN2000-50KTL-M3	type name
3 Einspeisung (einphasig/dreiphasig)	three-phase	no. of phases (single-phase/three-phase)
4 Nennscheinleistung	50	kVA rated apparent power
5 Nennwirkleistung	50	kW rated active power
6 AC-Nennspannung	400/480	V rated AC-voltage
7 AC-Nennfrequenz	50	Hz rated frequency
8 Beitrag zum Stoßkurzschlussstrom (i_{sc} nach IEC 60909-0)	0.1254	kA contribution to initial short circuit current (i_{sc} according to IEC 60909-0)
2 DC Eingangsgrößen		
DC Input		
1 Min. MPP-Spannung	200	V min. MPP voltage
2 Max. MPP-Spannung	1000	V max. MPP voltage
3 Max. PV-Eingangsspannung	1100	V max. DC input voltage
4 Max. PV-Eingangsstrom	30	A max. DC input current
5 Max. Modulleistung	55	kW _p max. peak power
3 Wechselrichter-Leistungsteil		
Converter-Power section		
1 Hersteller	HUAWEI TECHNOLOGIES CO.,LTD.	manufacturer
2 Typenbezeichnung	SUN2000-50KTL-M3	type name
3 Nennscheinleistung	50	kVA rated apparent power
4 Art (HF/NF-Trafo, trafolos)	without	generic type (HF/LF-transformer, without)
5 Taktfrequenz	20.4	kHz pulse rate of inverter
6 Art der Leistungsregelung (MPPT)	Advanced Climb	generic type of power control (MPPT)
7 Software-Version	V200R023	software version
4 Sonstige elektrische Komponenten		
Other electric components		
1 Art der Netzkopplung	3W+(N)+PE	generic type of interconnection
2 - Hersteller	HUAWEI TECHNOLOGIES CO.,LTD.	- manufacturer
3 - Typenbezeichnung	SUN2000-50KTL-M3	- type
4 Netzschutz integriert (Ja/Nein)	Yes	integrated grid protection (Yes/No)
5 Netzschutzhersteller	HUAWEI TECHNOLOGIES CO.,LTD.	grid protection manufacturer
6 - Typenbezeichnung	SUN2000-50KTL-M3	- type
7 Typenbezeichnung der Abschalteneinheit (angesteuert vom Netzschutz)	(HongFa) HFD42/4.5- 3SR	circuit breaker type controlled by the grid protection
8 Oberschwingungsfilter (ja/nein)	Yes	harmonic filter (yes/no)
5 Typenprüfung		
Type test		
1 Prüfbehörde	Bureau Veritas CPS VDE-AR-N 4110:2018- 11	testing authority
2 Aktenzeichen	VDE-AR-N 4120: 2018-11	reference
3 Seriennummer des Wechselrichters	ES2280031669	serial number of converter

Anschrift des Herstellers
Address of manufacturer

Zengyazha

Stempel, Datum, Unterschrift
stamp, date, signature

Anhang 5 / Annex 5

Herstellereklärung zur Einhaltung der technischen Anforderungen der VDE-AR-N 4110 / -4120

Manufacturer's declaration of compliance with the technical requirements of VDE-AR-N 4110 / -4120

Herstellereklärung zur Einhaltung der technischen Anforderungen der VDE-AR-N 4110:2018-11
 Manufacturer's declaration for compliance to technical requirements of the VDE-AR-N 4110:2018-11
 Datum / Date: 2023-01-15



Diese Erklärung wird ausgestellt von /
This declaration is made by

HUAWEI TECHNOLOGIES CO.,LTD.

Anschrift des Herstellers /
Address of manufacturer

Huawei Base, Bantian Longgang District Shenzhen, P.R. China

im Folgenden als Hersteller bezeichnet. /
hereinafter called manufacturer.

Die vom Hersteller gemachten Erklärungen innerhalb dieses Dokuments sind anwendbar und gültig für die nachfolgend aufgeführten EZE-Typen, die getestet wurden und zu zertifizieren sind. /
The declarations made by the manufacturer within this document are applicable and valid for the following PGU types tested and to be certified:

- SUN2000-50KTL-M3

im Folgenden als Erzeugungseinheit (EZE) bezeichnet. /
hereinafter called Power Generating Unit (PGU).

Anforderung / Requirement	Erklärung / Declaration
1. Allgemeine Informationen / General information	
Beschreibung des Aufbaus der Erzeugungseinheit mit Bild. / Description of the power circuit and provide a block diagram showing all relevant components.	See Anhang 1 / Annex 1.
Description of the main differences between the inverter models (different components and their main rating).	The units in der series are identical hardware platform. The implemented control and firmware is identical in all units. There is no difference regarding AC behavior between the PGU-types apart from the output voltage / power rating deviation and current limitation of each unit.
Beschreibung einer typischen Installation mit Bild. / Description of the remote control in a typical installation and provide a figure to show this.	See Anhang 2 / Annex 2.
Beschreibung der Verbindung mit einem Rundsteuerempfänger mit Bild. / Description of the connection to the ripple control receiver and provide a figure to show this.	See Anhang 3 / Annex 3.

Herstellereklärung zur Einhaltung der technischen Anforderungen der VDE-AR-N 4110:2018-11
Manufacturer's declaration for compliance to technical requirements of the VDE-AR-N 4110:2018-11
Datum / Date: 2023-01-15

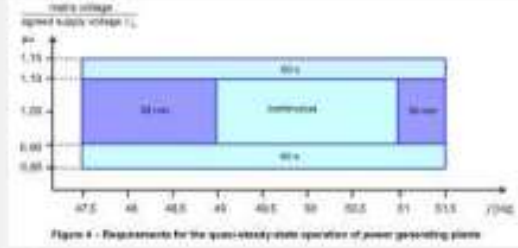
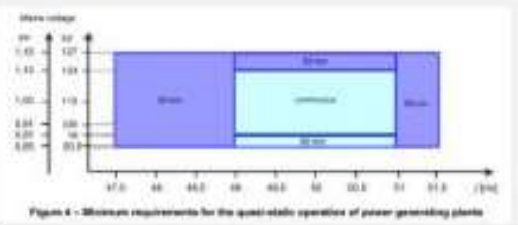

Anforderung / Requirement	Erklärung / Declaration
2. Quasistationärer Betrieb / Quasi-steady-state operation	
<p>Quasistationärer Betrieb im Frequenz- und Spannungsbereich gemäß Bild 4 ist möglich. / <i>Quasi-steady-state operation in the frequency and voltage range according to Figure 4 is possible.</i></p> <p>VDE-AR-N 4110:2018-11</p>  <p>Figure 4 - Requirements for the quasi-steady-state operation of power generating plants</p> <p>VDE-AR-N 4120:2018-11</p>  <p>Figure 4 - Minimum requirements for the quasi-steady operation of power generating plants</p>	<p>The entire power generating unit, respectively, including all its associated parts, has been designed for the frequency and voltage ranges of quasi-steady-state operation defined in Figure 4. Test results provided in TG3 test report.</p>
<p>Technische Mindestleistung der EZE / <i>Technical minimum power of the PGU</i></p>	<p>0% P_n.</p> <p>At 0% power setpoint the PGU stays connected without power feeding.</p> <p>The PGU can be disconnected from grid using the <i>Start/Stop control (gOD51_CrCmd_0)</i>.</p>

Anhang 5 / Annex 5

Herstellererklärung zur Einhaltung der technischen Anforderungen der VDE-AR-N 4110:2018-11
Manufacturer's declaration for compliance to technical requirements of the VDE-AR-N 4110:2018-11
 Datum / Date: 2023-01-15



Anforderung / Requirement	Erklärung / Declaration
---------------------------	-------------------------

3. Blindleistung / Reactive power

Jeder vom Netzbetreiber vorgegebene Sollwert kann im geforderten Blindleistungsstellbereich (Bild 5 (VDE-AR-N 4110/ VDE-AR-N 4120) oder) angefahren werden.

The required reactive power range can be provided.
See also sub-item below and **Fehler! Verweisquelle konnte nicht gefunden werden..**

/
Every setpoint value specified by the grid operator can be achieved within the required reactive power range (Figure 5 (VDE-AR-N 4110/ VDE-AR-N 4120) or Figure 6 (VDE-AR-N 4110/ VDE-AR-N 4120)).

VDE-AR-N 4110:2018-11

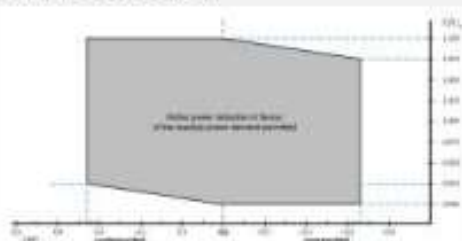

Figure 5 - Requirements for power generating plants with regard to the reactive power supply at the network connection point

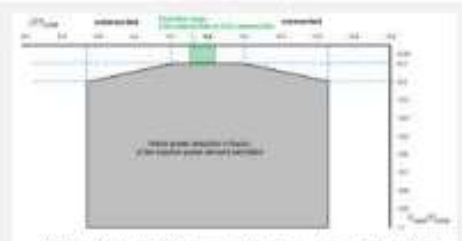

Figure 6 - (a) Diagrams of the power generating plant at the network connection point in the power to high-voltage system

VDE-AR-N 4120:2018-11

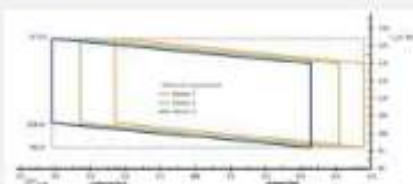



Figure 5 - Options of the requirements for power generating plants with regard to the reactive power supply at the network connection point



Figure 6 - Options for the (a) diagrams of the power generating plant at the network connection point in the power to high-voltage system

Herstellereklärung zur Einhaltung der technischen Anforderungen der VDE-AR-N 4110:2018-11
Manufacturer's declaration for compliance to technical requirements of the VDE-AR-N 4110:2018-11
Datum / Date: 2023-01-15





Anforderung / Requirement	Erklärung / Declaration
<p>Wirkleistungsreduzierung zu Gunsten der Blindleistungseinspeisung parametrierbar. /</p> <p>Active power reduction may be parametrized to the benefit of reactive power feed-in.</p> <p>Eine Reduzierung der Wirkleistungs-Einspeisung zugunsten der Blindleistungsbereitstellung ist zulässig. Hierbei handelt es sich nicht um eine Wirkleistungsreduzierung im Sinne des Einspeisemanagements nach EEG. /</p> <p><i>The active power feed-in is permitted to be reduced in favour of reactive power supply. This is not an active power reduction in the sense of the feed-in management required by the EEG.</i></p>	<p>The power provision is limited by the maximum apparent current and SUN2000-50KTL-M3, maximum apparent / active power provides 10,0%P_n overload capacity (i.e.P_{max} = 110,0%P_n);</p> <p>The reactive power is prioritised versus the active power.</p> <p>A maximum reactive power provision of 60%S_{max} (using Q set-point) or cosφ = 0,8 (using cosφ set-point) is possible.</p> <p>At overvoltage the apparent / active power threshold limit the injected power. At undervoltage the apparent current limitation will also contribute.</p> <p>The continuous provision is possible within the voltage corridor 80%U_n through 120%U_n and the frequency range between 47,5 and 51,5 Hz.</p> <p>A permanent active power reduction can be applied by setting parameters P_{limit} and P_{maxref} (the following applies: P_{limit} ≤ P_{maxref} ≤ P_{max}. Default: P_{limit} = P_{maxref} = P_{max}).</p> <p>The value of P_{limit} will then be the new active power limitation which will not be exceeded during operation of the PGU, while P_{maxref} will be the new reference for the P set-point control. Any signal for a setpoint of 100%P_{maxref}, by the ripple control receiver or other P-parameter setpoint, causes the PGU to inject the new lower P_{max}-value (active power higher than new lower P_{max}-value will never be injected). The reference power for percentage or p.u. in this limited mode is the new lower P_{maxref}-value.</p>
<p>Graphische und tabellarische Darstellung des Blindleistungsvermögens in Abhängigkeit der Spannung und Einspeisewirkleistung – PQ Diagramm (Angaben für 0,85U_n – 1,15U_n in 5%-Schritten erfolgt) /</p> <p><i>Representation of the reactive power capability as a function of the voltage and feed-in active power as an illustration and in a table – PQ diagram (Data for 0.85U_n – 1.15U_n provided in 5% steps)</i></p>	<p>See Fehler! Verweisquelle konnte nicht gefunden werden.</p>
<p>Die Arten der Sollwertvorgabe und Schnittstellen zur Regelung der Blindleistungsbereitstellung sind dokumentiert.</p> <p>Angabe der Q-Übergangsfunktion über eine Sprungantwort für die Schnittstellen/Sollwert-Kombinationen. /</p> <p><i>The types of setpoint value specifications and interfaces for control of the reactive power provision are documented.</i></p> <p><i>Details of the Q-step response via a step response for the interface / setpoint value combinations.</i></p>	<p>Following interfaces for control of the reactive power provision are provided on the PGU level, all interface can be seen in chapter 2.1 of SmartLogger ModBus Interface Definitions:</p> <ul style="list-style-type: none"> • Reactive power control mode: <ol style="list-style-type: none"> 2: Reactive power fix control 3: Power factor fix control 4: Q-U characteristic curve 14: Q-P characteristic curve

Anhang 5 / Annex 5

Herstellererklärung zur Einhaltung der technischen Anforderungen der VDE-AR-N
 4110:2018-11
 Manufacturer's declaration for compliance to technical requirements of the VDE-AR-N
 4110:2018-11
 Datum / Date: 2023-01-15

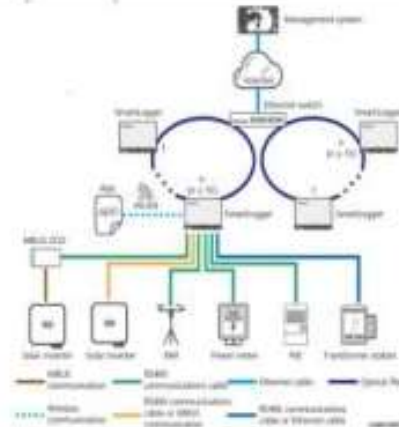

Anforderung / Requirement	Erklärung / Declaration
	 <ul style="list-style-type: none"> connect the inverter to Smartlogger via MBUS or RS485, the following reactive power control functions: <ul style="list-style-type: none"> Power factor fix control Reactive power fix control Q-P characteristic curve Q-U characteristic curve can be set using the WebUI.   <p>There are no differences regarding the setpoint accuracy and settling / response times between the interfaces / software tools.</p> <p>Hereby, the pick-up of a new reactive power setpoint is guaranteed within 2 s.</p>
<p>Angabe der Verfahren zur Blindleistungsbereitstellung implementiert an der EZE:</p> <ol style="list-style-type: none"> Blindleistung-Spannungskennlinie Q(U); Kennlinie Blindleistung als Funktion der Wirkleistung Q(P); Blindleistung mit Spannungsbegrenzungsfunktion; Verschiebungsfaktor $\cos\varphi$... 	<p>The following reactive power control functions are implemented on the PGU level:</p> <ol style="list-style-type: none"> Settable Q-parameter (range: +/- 60%Pmax) Settable $\cos\varphi$-set-parameter (range: +/- 0,8) Configurable Q(U)-characteristic line (No. of supporting points: 10) Configurable Q(P)-characteristic line (No. of supporting points: 10)

Anhang 5 / Annex 5

<p>Herstellereklärung zur Einhaltung der technischen Anforderungen der VDE-AR-N 4110:2018-11 Manufacturer's declaration for compliance to technical requirements of the VDE-AR-N 4110:2018-11 Datum / Date: 2023-01-15</p>	
---	---

Anforderung / Requirement	Erklärung / Declaration
<p><i>Details of methods for the reactive power supply implemented on PGU level:</i></p> <p>a) reactive power voltage characteristic curve $Q(U)$; b) characteristic curve of the reactive power as a function of the active power $Q(P)$; c) reactive power with voltage limiting function; d) displacement factor $\cos\varphi$ e) ... /</p>	
<p>VDE-AR-N 4110:2018-11/VDE-AR-N 4120:2018-11</p> <p>Das Regelverhalten der Blindleistung (Verfahren a), b) und c)) am Netzanschlusspunkt kann bei allen Sollwertsprüngen qualitativ nach einem PT1-Verhalten erfolgen. /</p> <p><i>For all abrupt set-point changes, the reactive power control (method a), b) and c)) can behave at the network connection point in qualitative correspondence to a PT1 behaviour (1. order lowpass)</i></p>	<p>Under the country code setting VDE-AR-N 4110/VDE-AR-N 4120 , for a Q step response the following control functions implemented on the PGU level:</p> <p>1) $\cos\varphi$ setpoint 2) $Q(P)$ 3) $Q(U)$</p> <p>show a PT1 behavior. :</p>
<p>VDE-AR-N 4110:2018-11/ VDE-AR-N 4120:2018-11</p> <p>Bei Umschaltung zwischen Regelverfahren kann die Anforderung an die Anschwing- und Einschwingzeit (der neue Sollwert nicht schneller als das geforderte PT1-Verhalten und nicht langsamer als in 4 min erreicht werden) erfüllt werden. /</p> <p><i>When switching over between control methods, the requirement of response time and settling time (the new set-point shall not be reached quicker than the required PT1 behaviour and within a time period of 4 min) can be fulfilled.</i></p>	<p>The required response time and settling time of the reactive power control can be provided by corresponding setting of the time constant parameter (for details see document <i>F.2_Huawei_SUN2000-50KTL_Series_Parameter list_V01</i>)</p>
<p>Im Falle einer Kommunikationsstörung zum EZA Regler können EZE mit einem vorgegebenen Wert bzw. Verfahren betrieben werden. /</p> <p><i>In the event the communication with the PGS controller is disturbed, PGU can be operated with a predefined value or process.</i></p>	<p>In the event the communication with the PGS controller is disturbed, the PGU will remain in operation with the last setpoint value.</p>

Anhang 5 / Annex 5

Herstellererklärung zur Einhaltung der technischen Anforderungen der VDE-AR-N 4110:2018-11
Manufacturer's declaration for compliance to technical requirements of the VDE-AR-N 4110:2018-11
Datum / Date: 2023-01-15



Anforderung / Requirement	Erklärung / Declaration
---------------------------	-------------------------

4. Wirkleistung / Active power

Angabe zu Schnittstellen zur Wirkleistungsvorgabe (Netzbetreiber, Direktvermarkter) getrennt umgesetzt sowie konzeptionell überprüft, ob niedrigster Wirkleistungswert übernommen wird (auch bei sich zeitlich überschneidenden Vorgaben). /

Details of interfaces for specifying active power (grid operator, direct seller) implemented separately as well as the concept checked to make sure lowest active power value is accepted (even if specifications overlap in time).

Only one Interface for specifying active power implemented on the PGU. Separate specifying active power by grid operator and direct seller is not possible. For prioritization of different setpoints must be carried out on the plant level e.g. in the superimposed PGS controller.

Following interfaces for control of the active power provision are provided on the PGU level: all interface can be seen in chapter 2.1 of SmartLogger ModBus Interface Definitions:

- Reactive power control mode:
3: Percentage fixed-value limitation (open loop)

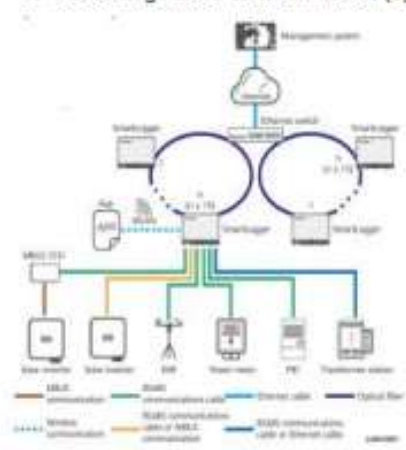

- connect the inverter to Smartlogger via MBUS or RS485 for active power setting using the WebUI using the parameter *Fixed active power derated* or *Active power percentage derating*.



There are no differences regarding the setpoint accuracy and settling / response times between the interfaces / software tools.

Hereby, the pick-up of a new active power setpoint is guaranteed within 2 s.

Anhang 5 / Annex 5

Herstellererklärung zur Einhaltung der technischen Anforderungen der VDE-AR-N 4110:2018-11 <i>Manufacturer's declaration for compliance to technical requirements of the VDE-AR-N 4110:2018-11</i> Datum / Date: 2023-01-15	
Anforderung / Requirement	Erklärung / Declaration
Angabe zur Wirkleistungsabgabe abhängig von Umgebungsbedingungen (Temperatur, Luftdruck). <i>Details of active power output dependent on environmental conditions (temperature, atmospheric pressure).</i>	The active power output of the PGU is dependent on the ambient temperature. See Anhang 5 / Annex 5.
Verfahren der Wirkleistungsgradienten wird in der Erzeugungseinheit / im EZA-Regler implementiert. <i>The active gradient method is implemented in the power generating unit / in the PGP controller.</i>	The active gradient method is implemented on the PGU level (parameter <i>Active power change gradient</i> , for details see document <i>F.2 Huawei SUN2000-50KTL Series_Parameter list_V01</i>)
5. Wirkleistungsabgabe in Abhängigkeit der Netzfrequenz / Active power output as a function of grid frequency	
Die Frequenzmessung erfüllt die Anforderungen hinsichtlich Genauigkeit und Abtastung: <ul style="list-style-type: none"> • $\Delta f \leq 10$ mHz im eingeschwungenen Zustand • $\Delta f \leq 50$ mHz bei schnellen Frequenzänderungen • $\Delta t_{\text{Abtast}} \leq 200$ ms bei schnellen Frequenzänderungen / <i>The frequency measurement meets the requirements with respect to accuracy and sampling:</i> <ul style="list-style-type: none"> • $\Delta f \leq 10$ mHz in the settled condition • $\Delta f \leq 50$ mHz for fast frequency changes • $\Delta t_{\text{Abtast}} \leq 200$ ms for fast frequency changes 	Ja / Yes.
Die Wirkleistungsreduktion ist bis zur technischen Mindestleistung der EZE möglich. / <i>The active power reduction is possible down to the technical minimum power of the PGU.</i>	Ja / Yes. The min. active power in case of overfrequency derating can be limited using parameter <i>Cutoff power of overfrequency deating</i> . The PGU can be operated by an active power setpoint of 0.
Die anfängliche Zeitverzögerung T_V der frequenzabhängigen Wirkleistungsvariation beträgt nicht mehr als 2 s. / <i>The initial time delay T_V of the frequency-dependent active power variation is not more than 2 s.</i>	Ja / Yes. The initial time delay of the frequency-dependent active power variation is defined as 0 ms.
<ul style="list-style-type: none"> • Oberhalb $f_{\text{stop}} >$ kann die EZE noch weitere 5 s ohne Wirkleistungssteigerung betrieben werden. • Eine Netztrennung erfolgt nur aus Gründen des Eigenschutzes / • <i>The PGU can be operated another 5 s without active power increase above $f_{\text{stop}} >$.</i> • <i>Separation from the grid only takes place for reasons of self-protection.</i> 	Ja / Yes. The PGU can remain in operation in case that the grid frequency increases above $f_{\text{stop}} >$ but not triggered by the grid protection or self-protection, in this case the active power will be kept at the power level defined by parameter <i>Cutoff power of overfrequency deating</i> .
EZE durchfahren schnelle Frequenzänderungen (RoCoF) ohne Trennung vom Netz: <ul style="list-style-type: none"> • $\pm 2,00$ Hz/s in gleitendem 0,5 s-Zeitfenster; • $\pm 1,50$ Hz/s in gleitendem 1,0 s-Zeitfenster; • $\pm 1,25$ Hz/s in gleitendem 2,0 s-Zeitfenster 	Ja / Yes.

Anhang 5 / Annex 5

Herstellereklärung zur Einhaltung der technischen Anforderungen der VDE-AR-N 4110:2018-11 Manufacturer's declaration for compliance to technical requirements of the VDE-AR-N 4110:2018-11 Datum / Date: 2023-01-15	
--	---

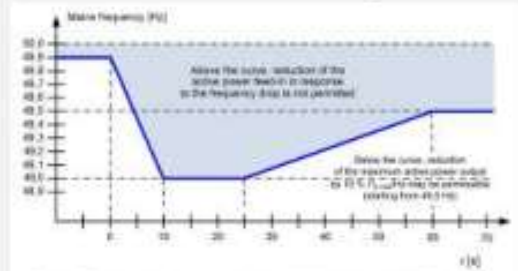
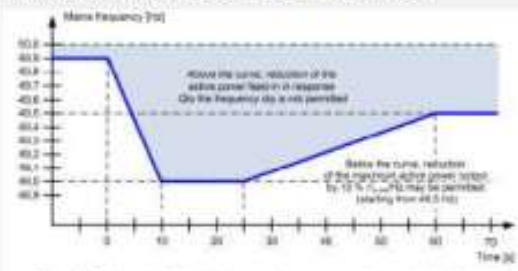
Anforderung / Requirement	Erklärung / Declaration
<p>können ohne Netztrennung durchfahren werden. <i>PGU transit through fast frequency changes (RoCoF) without disconnecting from the grid:</i></p> <ul style="list-style-type: none"> $\pm 2.00 \text{ Hz/s}$ in rolling 0.5 s window; $\pm 1.50 \text{ Hz/s}$ in rolling 1.0 s window; $\pm 1.25 \text{ Hz/s}$ in rolling 2.0 s window <p>can be transited without disconnection from the grid.</p>	
<p>VDE-AR-N 4110:2018-11</p> <p>Im Bereich zwischen 50 Hz und der Kurve in Bild 17 reduzieren EZE ihre Wirkleistung nicht. / <i>In the range between 50 Hz and the curve in Figure 17, PGUs do not reduce their active power.</i></p> <div style="text-align: center;">  <p>Figure 17 – Requirement for the output power of the power generating units in the dynamic short-time range</p> </div>	<p>Ja / Yes.</p>
<p>VDE-AR-N 4120:2018-11</p> <p>Im Bereich zwischen 50 Hz und der Kurve in Bild 14 reduzieren EZE ihre Wirkleistung nicht. / <i>In the range between 50 Hz and the curve in Figure 14, PGUs do not reduce their active power.</i></p> <div style="text-align: center;">  <p>Figure 14 – Requirement for the output power of the power generating units in the dynamic short-time range</p> </div>	<p>Ja / Yes.</p>
<p>VDE-AR-N 4120:2018-11 Ein Betriebsvermögen oberhalb 51,5 Hz ist ausgewiesen, sofern vorhanden. / <i>An operating capability above 51.5 Hz has been shown, if present.</i></p>	<p>The PGU can remain in operation at the grid frequency above 51,5 Hz if not interfered by the grid protection setting.</p>
<p>6. Zuschaltbedingungen / <i>Switching-in conditions</i></p>	
<p>Das Verfahren des Zuschaltens wird in der EZE / im EZA-Regler umgesetzt. /</p>	<p>The procedure of the connection is implemented in the PGU level (for details see document</p>

Anhang 5 / Annex 5

Herstellererklärung zur Einhaltung der technischen Anforderungen der VDE-AR-N 4110:2018-11 <i>Manufacturer's declaration for compliance to technical requirements of the VDE-AR-N 4110:2018-11</i> Datum / Date: 2023-01-15	
Anforderung / Requirement	Erklärung / Declaration
The procedure of the connection is implemented in the PGU / PGS controller.	F_2_Huawei_SUN2000-50KTL_Series_Parameter_list_V01
Eine Zuschaltung bei 47,5Hz \pm 0,1Hz und bei 50,2Hz \pm 0,1Hz sowie bei 90%U _n \pm 2%U _n und 110%U _n \pm 2% U _n möglich ist. / <i>A connection is possible for 47,5Hz \pm 0,1Hz and 50,2Hz \pm 0,1Hz as well as at 90%U_n \pm 2%U_n and 110%U_n \pm 2% U_n.</i>	Ja / Yes.
VDE-AR-N 4120:2018-11 <i>Beschreibung des Konzepts der Wiedereinschaltung.</i> <i>The concept for reconnection has to be described.</i>	Following describes the reconnection concept implemented on the PGU level: After tripping by protection equipment the integrated protection relay will keep monitoring the grid voltage and frequency. If the reconnection conditions are met the timer (corresponding to the set reconnection delay) will start to count. During the reconnection process if a new grid fault is detected, the timer will be reset. After the timer running out the integrated disconnection devices will be closed and the active power will ramp up according to the defined gradient. The reconnection can be switched between manual reconnection mode and automatic reconnection mode using the parameter <i>Auto start upon grid recovery</i> .
7. Insel- und Teilnetzbetriebsfähigkeit / Island and partial grid operation capability	
Angabe zur Inselbetrieb und Teilnetzbetriebsfähigkeit falls diese möglich ist. / <i>Details of islanding operation and partial grid operation capability if possible.</i>	N/A. The PGU does not provide islanding operation and partial grid operation capability.
8. Fähigkeit zur Bereitstellung von Primärregelleistung / Capability of primary control energy supply	
Falls die Erzeugungseinheit in der Lage ist, Primärregelleistung bereitzustellen, ist das Regelungskonzept der Erzeugungseinheit zu beschreiben: <ul style="list-style-type: none"> dass die Regelung der Erzeugungseinheit die Bereitstellung von Primärregelleistung priorisiert, auch wenn eine Änderung der Wirkleistungsabgabe aus anderen Gründen vorliegt dass die Erzeugungseinheit die Primärregelleistung im Bereich von 10%P_r bzw. technischer Mindestleistung und 100%P_r erbringen kann. / <i>If the power generating unit is able to provide primary control energy supply, the control concept has to be described:</i> <ul style="list-style-type: none"> that the power generating unit control gives priority to the supply of primary control energy even when there is a change in the active power output for other reasons; 	N/A. The PGU does not provide primary control energy supply.

Anhang 5 / Annex 5

Herstellereklärung zur Einhaltung der technischen Anforderungen der VDE-AR-N 4110:2018-11
Manufacturer's declaration for compliance to technical requirements of the VDE-AR-N 4110:2018-11
Datum / Date: 2023-01-15



Anforderung / Requirement	Erklärung / Declaration													
<ul style="list-style-type: none"> that the power generating unit is able to supply the primary control energy in the range between $10\%P_{e-}$ or the minimum technical power, respectively, and $100\%P_{e-}$. 														
9. Dynamische Netzstützung / Dynamic grid support														
Angabe zur FRT-Grenzkurve. / Provide a FRT limit curve.	See Anhang 6 / Annex 6													
Eine Typ-2-Erzeugungseinheit ist in der Lage, mehrfach aufeinanderfolgende Spannungseinbrüche durchzufahren. Die Erzeugungseinheit ist nach 30 min erneut in der Lage, einen weiteren Mehrfachfehler durchzufahren. / A Type-2 power generating unit is able to ride through several consecutive voltage dips. After 30 min, the power generating unit is able again to ride through a further multiple fault.	Ja / Yes.													
Herstellerangabe erforderlich: / Manufacturer specifications needed: Table 12 – Extent of the information on short-circuit current contributions to be given in the unit certificate	SUN2000-50KTL-M3 <ul style="list-style-type: none"> $I_{skDP} = 79.8A@400V;66.5A@480V$ $I_{1Jsk2DP} = 79.8A@400V;66.5A@480V$ $I_{1Jsk1DP} = 79.8A@400V;66.5A@480V$ $Z_{12JDP} = 0,5$													
<table border="1"> <thead> <tr> <th>Type of power generating unit</th> <th>Information</th> <th>Symbol</th> </tr> </thead> <tbody> <tr> <td rowspan="3">Power generating units with full switchgear protection</td> <td>R1.m.a. value of the source current for three-phase fault</td> <td>I_{skDP}</td> </tr> <tr> <td>R1.m.a. value of the source current for two-phase fault</td> <td>$I_{1Jsk2DP}$</td> </tr> <tr> <td>R1.m.a. value of the source current for single-phase fault</td> <td>$I_{1Jsk1DP}$</td> </tr> <tr> <td>Negative-sequence short-circuit impedance (manufacturer information for voltage <math>U_{N1}</math> only)</td> <td></td> <td>Z_{12JDP}</td> </tr> </tbody> </table>	Type of power generating unit	Information	Symbol	Power generating units with full switchgear protection	R1.m.a. value of the source current for three-phase fault	I_{skDP}	R1.m.a. value of the source current for two-phase fault	$I_{1Jsk2DP}$	R1.m.a. value of the source current for single-phase fault	$I_{1Jsk1DP}$	Negative-sequence short-circuit impedance (manufacturer information for voltage U_{N1} only)		Z_{12JDP}	
Type of power generating unit	Information	Symbol												
Power generating units with full switchgear protection	R1.m.a. value of the source current for three-phase fault	I_{skDP}												
	R1.m.a. value of the source current for two-phase fault	$I_{1Jsk2DP}$												
	R1.m.a. value of the source current for single-phase fault	$I_{1Jsk1DP}$												
Negative-sequence short-circuit impedance (manufacturer information for voltage U_{N1} only)		Z_{12JDP}												
10. Schutz / Protection														
Die Schutzeinrichtungen an den Erzeugungseinheiten wurden so ausgeführt, dass die eingestellten Werte einfach und ohne zusätzliche Hilfsmittel ablesbar sind oder falls zusätzliche Hilfsmitteln notwendig sind ist die Authentizität und Identifikation der ausgelesenen Daten eindeutig sichergestellt. / The protection devices on the power generating units have been designed in such a way that the settings can be easily read without additional equipment or if additional equipment is required, the authenticity and identification of the data read out is ensured.	The integrated grid monitoring/protection parameters can be checked per remote via WebUI or via SUN2000 app using a mobile phone. And WebUI or SUN2000 app can identify the inverter through SN.													
<ul style="list-style-type: none"> Für alle Kurzschlusschutz- und Entkopplungsschutzeinrichtungen in der Erzeugungseinheit Vorrichtungen wie beispielsweise Prüfklemmenleisten vorgesehen wurden, um Schutzprüfungen ohne Ausklemmen von Drähten zu ermöglichen; / Devices, such as, e.g., test terminal strips, have been provided for all short-circuit and decoupling protection equipment in the power generating unit to allow protection tests to be conducted without having to disconnect wires; 	The PGU does not provide test terminals for on-site testing. For necessary on-site testing, an external monitoring relay with corresponding test terminals must be installed and the PGU's monitoring parameters must be set accordingly.													

Anhang 5 / Annex 5

Herstellereklärung zur Einhaltung der technischen Anforderungen der VDE-AR-N 4110:2018-11
Manufacturer's declaration for compliance to technical requirements of the VDE-AR-N 4110:2018-11
 Datum / Date: 2023-01-15

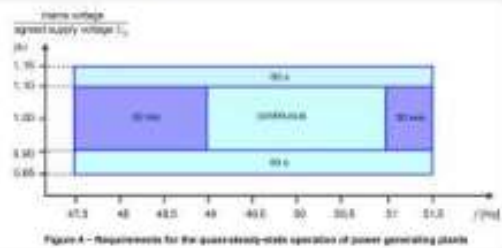
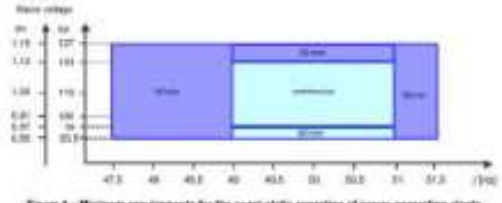

Anforderung / Requirement	Erklärung / Declaration
<ul style="list-style-type: none"> Die Schutzeinrichtungen mit einer netzunabhängigen Hilfsenergie werden für mindestens 5s versorgt. / <i>Grid-independent auxiliary energy is supplied to the protection equipment for at least 5s</i> Funktionsfähigkeit der Schutzfunktionen ist innerhalb der in Bild 4 gegebenen Betriebsbereiche gegeben. / <i>Functionality of the protection functions within the operating ranges shown in Figure 4 can be provided.</i> <p>VDE-AR-N 4110:2018-11</p>  <p>Figure 4 – Requirements for the quasi-steady-state operation of power generating plants</p>	<p>The grid monitoring functions can be maintained for at least 5 s during grid voltage loss.</p> <p>Ja / Yes.</p>
<p>VDE-AR-N 4120:2018-11</p>  <p>Figure 4 – Minimum requirements for the quasi-steady-state operation of power generating plants</p>	<p>Ja / Yes.</p> <p>The loss of power supply for the grid monitoring results in a non-delayed triggered disconnection.</p>
<ul style="list-style-type: none"> Ein Ausfall der Hilfsenergie der Schutzeinrichtungen bzw. der Anlagensteuerung führt zum unverzügerten Abschalten der Erzeugungseinheit; / <i>An auxiliary energy loss of the protection equipment or the equipment control, respectively, causes the power generation to be switched off without delay;</i> Die Spannungswandler sind an den Erzeugungseinheiten netzseitig vom Leistungsschalter der Erzeugungseinheit installiert; / <i>The voltage transformers are installed at the power generating units on the network side of the of the power generating unit's circuit-breaker;</i> Im Falle der Nutzung eines integrierten Schutzes in den Erzeugungseinheiten dieser autark von Steuerungsfunktionen arbeitet. Die integrierten Schutzfunktionen sind in getrennten 	<p>Ja / Yes.</p> <p>The integrated protection functions are implemented independent from other parameters and control functions.</p>

Anhang 5 / Annex 5

Herstellereklärung zur Einhaltung der technischen Anforderungen der VDE-AR-N 4110:2018-11 <i>Manufacturer's declaration for compliance to technical requirements of the VDE-AR-N 4110:2018-11</i> Datum / Date: 2023-01-15	
--	---

Anforderung / Requirement	Erklärung / Declaration
Softwarebausteinen realisiert und arbeiten autark von Steuerungsfunktionen; / <ul style="list-style-type: none"> • <i>The integrated self-protection in the power generating units, if used, works independent of any control functions. The integrated protection functions are implemented in separate software modules and that they operate independent from control functions;</i> • Die Funktionsfähigkeit der Schutzfunktionen vor Aufnahme der Leistungseinspeisung ist durch die Erzeugungseinheiten gegeben. / • <i>Operability of the protection functions shall be provided before the power generating units start feeding in power.</i> 	Ja / Yes.
Kuppelschalter / <i>Coupling switch</i> :	Note: The following describes the PGU integrated disconnection relay.
<ul style="list-style-type: none"> • Der Kuppelschalter stellt eine dreipolige galvanische Trennung sicher. • <i>The coupling switch ensures three-pole galvanic separation.</i> 	Ja / Yes.

Anhang 5 / Annex 5

Herstellererklärung zur Einhaltung der technischen Anforderungen der VDE-AR-N 4110:2018-11 <i>Manufacturer's declaration for compliance to technical requirements of the VDE-AR-N 4110:2018-11</i> Datum / Date: 2023-01-15		
---	--	---

Anforderung / Requirement	Erklärung / Declaration
<ul style="list-style-type: none"> Der Kuppelschalter ist gemäß der Herstellerangabe ausgelegt. Das Schaltvermögen des Kuppelschalters ist angegeben. <i>The coupling switch is designed as specified by the manufacturer. The switching capacity of the coupling switch is stated.</i> 	Ja / Yes.
<ul style="list-style-type: none"> Der Kuppelschalter ist unter Berücksichtigung der nach 10.3 erforderlichen Schutzeinrichtung unverzüglich auslösbar <i>The coupling switch is able to be triggered without delay taking into account the protection equipment required according to 10.3.</i> 	Ja / Yes.
<ul style="list-style-type: none"> Die Summe aus den Eigenzeiten der Schutz- und Schalteinrichtung überschreitet nicht 100 ms <i>The sum of time elements of the protection and switching equipment does not exceed 100 ms</i> 	Ja / Yes.

Shanghai	2023-01-15	<i>Zengyuzhu</i>
Ort / Place	Datum / Date	Stempel, Unterschrift / stamp, signature

Der Unterzeichner erklärt sein Verständnis der obigen Sachverhalte und seine Bestätigung nach bestem technischem Verständnis. /

The subscriber declares his understanding of the aforementioned facts and his confirmation according to best technical understanding.

Anhang 5 / Annex 5

Herstellererklärung zur Einhaltung der technischen Anforderungen der VDE-AR-N
 4110:2018-11
 Manufacturer's declaration for compliance to technical requirements of the VDE-AR-N
 4110:2018-11
 Datum / Date: 2023-01-15



Anhang 1 / Annex 1:

Description of the power circuit of the PGU

Description of the electrical circuit: (Figure 1)

The internal control is redundant built. It consists of Master CPU(U3)and Slave CPU(033).

The Master CPU(U3)control the relays by switching signals measures the PV voltage, PV current, Bus voltage, grid voltage, frequency, AC current with injected DC and the array insulation resistance to ground. In addition it tests the current sensors and the RCMU circuit before each start up.

The Slave CPU (U33) is measures the grid voltage , grid frequency , DCI and residual current , also can switch off the relays independently , and communicate with the Master CPU (U3) each other .

The current is measured by a current sensor. The AC current signal and the injected DC current signal are sent to the Master CPU (U3). The Master CPU (U3) tests and calibrates before each start up all current sensors.

The unit provides two relays in series in all output conductors. When single fault applied to one relay, alarm an error code in display panel, another redundant relay provides basic insulation maintained between the PV array and the mains. All the relays are tested before each start up.

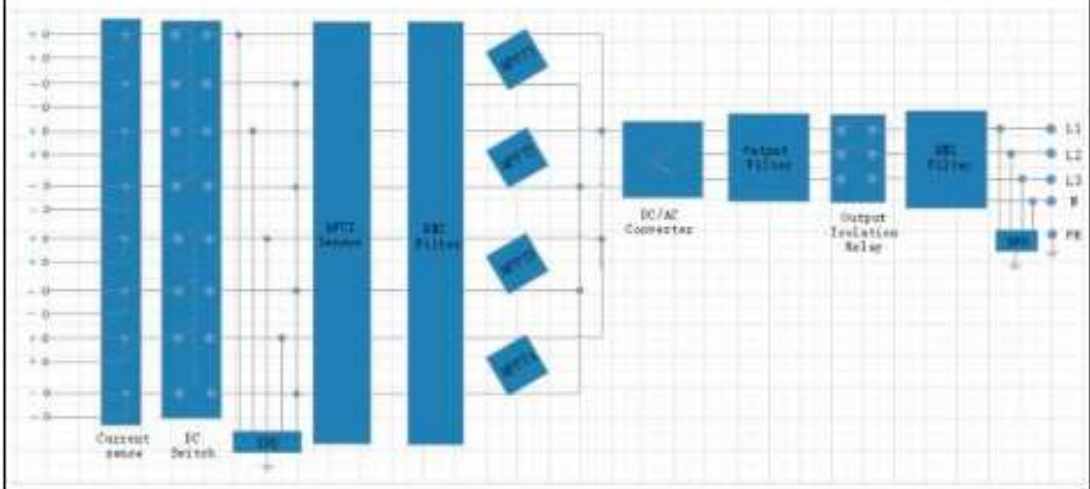

Herstellereklärung zur Einhaltung der technischen Anforderungen der VDE-AR-N 4110:2018-11
Manufacturer's declaration for compliance to technical requirements of the VDE-AR-N 4110:2018-11
 Datum / Date: 2023-01-15



Anhang 2 / Annex 2:

Description of the remote control in a typical installation

In the RS485 communication mode a SUN2000 system (including up to 30 units recommended by manufacturer each RS485 port) can be connected to the SmartLogger (data collector) via RS485 bus.

A SmartLogger (data collector) can be connected to a SUN2000 system (including up to 30 units recommended by manufacturer each RS485 port) connected in series via RS485 communication cable (using MODBUS-RTU communication protocol). The length of the communication cable should be limited to max. 1000 m (for RS485 bus using 9600 baud rate). SmartLogger can control active / reactive power control via dry contact. The Ethernet-interface and corresponding WebUI "Data Collector Web" are available for setting / controlling active / reactive power and parameter configuration.

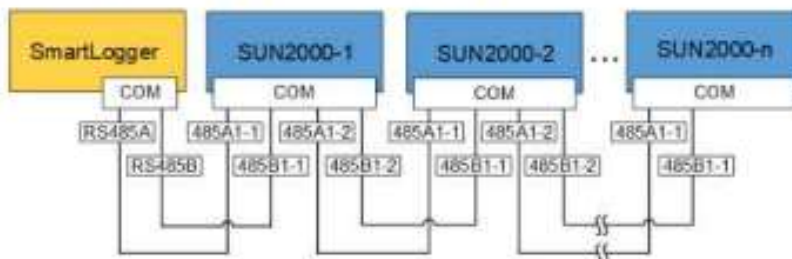

Anhang 5 / Annex 5

Herstellereklärung zur Einhaltung der technischen Anforderungen der VDE-AR-N

4110:2018-11

Manufacturer's declaration for compliance to technical requirements of the VDE-AR-N

4110:2018-11

Datum / Date: 2023-01-15



Anhang 3 / Annex 3:

Description of the connection to the remote control receiver

A generating station can receive the signal from the State Load Dispatch Centre or Regional Load Dispatch Centre for regulation of the active and reactive power output using the Smart Logger (data acquisition device).

The remote control receiver can be connected to the Smart Logger using dry contact for active / reactive power control, which is connected to the inverters via RS485/MBUS.

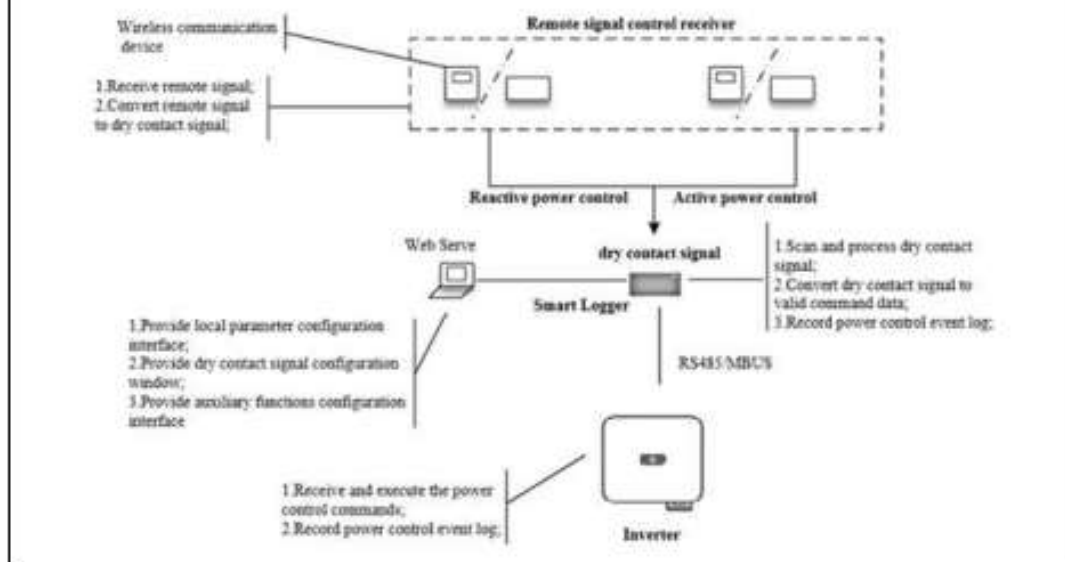

Anhang 5 / Annex 5

Herstellereklärung zur Einhaltung der technischen Anforderungen der VDE-AR-N
4110:2018-11
Manufacturer's declaration for compliance to technical requirements of the VDE-AR-N
4110:2018-11
Datum / Date: 2023-01-15



Anhang 4 / Annex 4:

Operating points in the voltage dependent PQ diagram:

SUN2000-50KTL-M3

$U_n = 1.00 / 1.10$ p.u.

P (kW)	Q (kvar)	
55.00	0.00	0.00
50.60	21.5	-21.5
46.00	30.00	-30.00
41.40	33.00	-33.00
36.80	33.00	-33.00
32.20	33.00	-33.00
27.6	33.00	-33.00
23.00	33.00	-33.00
18.4	33.00	-33.00
13.8	33.00	-33.00
9.2	33.00	-33.00
4,6	33.00	-33.00
0,00	33.00	-33.00
$U_n = 0.95$ p.u.		
P (kW)	Q (kvar)	
49.50	0.00	0.00
44.88	21.10	-21.10
40.25	28.80	-28.80
35.63	33.00	-33.00
31.00	33.00	-33.00
26.38	33.00	-33.00
21.75	33.00	-33.00
17.13	33.00	-33.00
12.50	33.00	-33.00
7.88	33.00	-33.00
3.25	33.00	-33.00
0.00	33.00	-33.00
$U_n = 0.85$ p.u.		
P (kW)	Q (kvar)	
46.75	0.00	0.00
42.50	19.50	-19.50
38.25	26.80	-26.80
34.00	33.00	-33.00
29.75	33.00	-33.00
25.50	33.00	-33.00
21.25	33.00	-33.00

Herstellereklärung zur Einhaltung der technischen Anforderungen der VDE-AR-N 4110:2018-11
Manufacturer's declaration for compliance to technical requirements of the VDE-AR-N 4110:2018-11
 Datum / Date: 2023-01-15



17.00	33.00	-33.00
12.75	33.00	-33.00
8.50	33.00	-33.00
4.25	33.00	-33.00
0.00	33.00	-33.00



Herstellereklärung zur Einhaltung der technischen Anforderungen der VDE-AR-N
4110:2018-11
Manufacturer's declaration for compliance to technical requirements of the VDE-AR-N
4110:2018-11
Datum / Date: 2023-01-15



Anhang 5 / Annex 5:

Active power output dependent on ambient temperature:

SUN2000-50KTL-M3 Temperature derating curve

Temperature [°C]	Temperature [°C]		
	400 [V _{ac}]	600 [V _{ac}]	800 [V _{ac}]
-25	-25	-25	-25
30	30	30	30
35	35	35	35
40	40	40	40
45	45	45	45
50	50	50	50
60	60	60	60

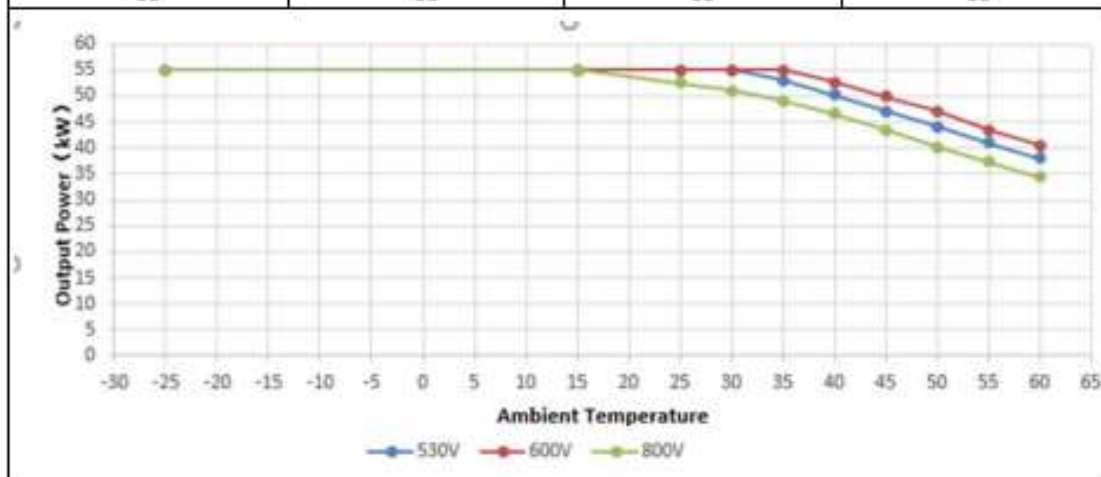

Anhang 5 / Annex 5

Herstellererklärung zur Einhaltung der technischen Anforderungen der VDE-AR-N
 4110:2018-11
 Manufacturer's declaration for compliance to technical requirements of the VDE-AR-N
 4110:2018-11
 Datum / Date: 2023-01-15



Anhang 6 / Annex 6:

Fault Ride-Through (FRT) limit curve:

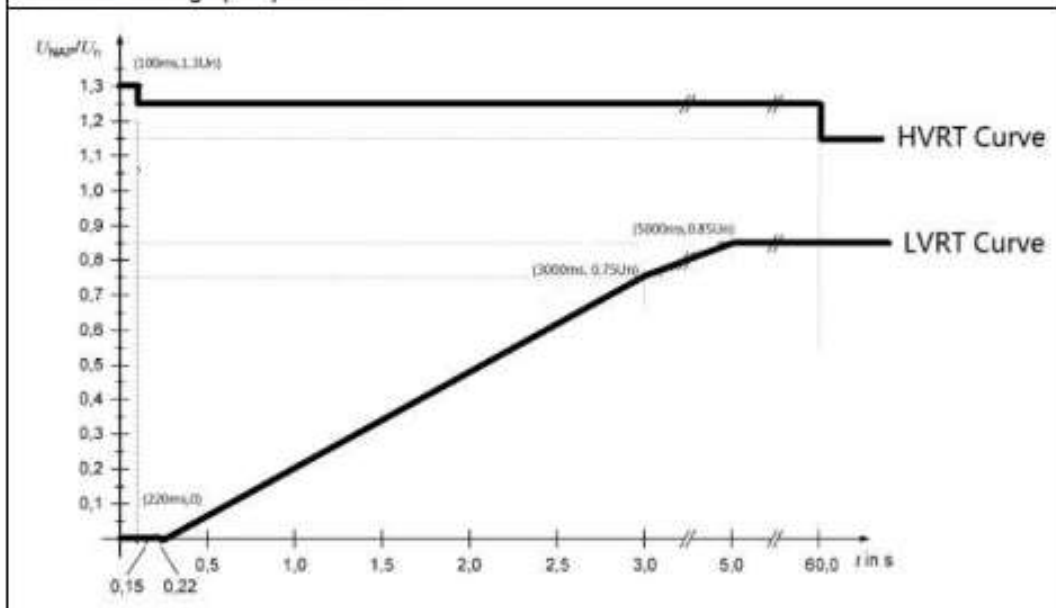

Anhang 6 / Annex 6

Parameterliste des SUN2000-50KTL-M3 / parameter list of SUN2000-50KTL-M3



HUAWEI Huawei Technologies Co., Ltd.

Version: V1.0

Parameter list of SUN2000-50KTL-M3

1. General information regarding the Parameter list

Manufacturer:	Huawei Technologies Co., Ltd.
Created by:	Zengyuzhu <i>Zengyuzhu</i>
Created on:	2023.01.15
Revised on:	V1.0

2. Information regarding the power generating unit

Type designation	Rated power [kW]	Rated active current [A] (at $\cos\varphi = 1$)
SUN2000-50KTL-M3	50	79.8A@400V 66.5A@480V

3. Parameter set during the measurement

If no noted otherwise the following standard parameters were used during the measurement.
All adaptations to the standard parameters used during the measurement were documented in the TG3 test report.

4. Main Components of the regulating system

Main components of the control system with firmware and software	
Main component(s) of the control system	Control system integrated in the PGU
Firmware version	V200R023
Software version	V200R023

5. Relevant parameters for the electrical behaviour

No.	Name	Description	Unit	Setting range		Default value (acc. to parameter set)
				Min.	Max.	
General parameter settings (rated values or reference values)						
1	Pn	Rated active power	kW	parameter not adjustable		SUN2000-50KTL-M3:50
2	Smax	Max apparent power	kVA	parameter not adjustable		SUN2000-50KTL-M3:55
3	Un	Rated voltage	V	parameter not adjustable		SUN2000-50KTL-M3:400V/480V
4	In	Rated current	A	parameter not adjustable		SUN2000-50KTL-M3:79.8(400V)/84.0(480V)
5	Fn	Rated frequency	Hz	parameter not adjustable		50

Anhang 6 / Annex 6



HUAWEI Huawei Technologies Co., Ltd.

Version: V1.0

No.	Name	Description	Unit	Setting range		Default value (acc. to parameter set)
				Min.	Max.	
Active power peaks						
6	Pmax	Maximum active power limit	kW	parameter not adjustable		SUN2000-50KTL-M3:55
7	Maximum active power	Plimit	kW	0.100	Pmax	Pmax
8	Active power baseline	Pmaxref	kW	0.100	Pmax	Pmax
Operating power limited by grid operator						
9	Trigger frequency of underfrequency rise power	Start frequency P(f) (Start of frequency regulation - power rise)	---	Disable / Enable		Disable
10	Quit frequency of underfrequency rise power	Quit frequency P(f) (End of frequency regulation - power rise)	%Pmaxref/s	0.100	1000.000	0.5
11	Cutoff frequency of underfrequency rise power	End frequency P(f) (End of frequency regulation - power rise)	kW	0.0	Plimit	Plimit
12	Cutoff power of underfrequency rise power	End power P(f) (End of power of frequency regulation - power rise)	%Pmaxref	0.0	100.0	100.0
13	Power recovery gradient of underfrequency rise power	Power recovery gradient when quit underfrequency rise power	%(0.6Smax)/s	0.100	1000.000	125
14	Trigger frequency of underfrequency rise power	Start frequency P(f) (Start of frequency regulation - power rise)	s	1	1000	10
Active power feed-in as a function of grid frequency						
15	Overfrequency derating	Overfrequency derating function enable	---	Disable / Enable		Enable
16	Trigger frequency of over frequency derating	Start frequency P(f) (Start of frequency regulation - power reduction)	Hz	40	60	50.20
17	Quit frequency of over frequency derating	Quit frequency P(f) (End of frequency regulation - power reduction)	Hz	40	60	50.15
18	Cutoff frequency of over frequency derating	End frequency P(f) (End of frequency regulation - power reduction)	Hz	40	60	51.50

Anhang 6 / Annex 6



HUAWEI Huawei Technologies Co., Ltd.

Version: V1.0

No.	Name	Description	Unit	Setting range		Default value (acc. to parameter set)
				Min.	Max.	
19	Cutoff power of over frequency derating	End power P(f) (End of power of frequency regulation - power reduction)	%PM	0	100	48
20	Power recovery gradient of overfrequency derating	Power recovery gradient when quit overfrequency derating	%Prated/min	1	6000	10
21	Underfrequency rise power	Underfrequency derating function enable	-	Disable /Enable		Disable
22	Trigger frequency of underfrequency rise power	Start frequency P(f) (Start of frequency regulation - power rise)	Hz	40	60	49.80
23	Quit frequency of underfrequency rise power	Quit frequency P(f) (End of frequency regulation - power rise)	Hz	40	60	49.90
24	Cutoff frequency of underfrequency rise power	End frequency P(f) (End of frequency regulation - power rise)	Hz	40	60	47.50
25	Cutoff power of underfrequency rise power	End power P(f) (End of power of frequency regulation - power rise)	%Pmax	0	100	92
26	Power recovery gradient of underfrequency rise power	Power recovery gradient when quit underfrequency rise power	%Prated/min	1	6000	10
<p>Note:</p> <p>The required gradient (or droop) of the frequency dependent active power derating can be defined using the Parameters <i>Trigger frequency of over frequency derating</i>, <i>Cutoff frequency of over frequency derating</i> and <i>Cutoff power of over frequency derating</i>.</p>						
Active power gradient following disconnection from the grid						
27	Soft start time after grid failure	The soft start time the active power from 0 to power rated after fault	s	1	1800	600
Reconnection time following disconnection from the grid						
28	Grid connection duration after power grid recovery	Time until reconnection	s	0	7200	60
Reactive power provision						
a) Power factor fix control						
29	Power factor	Cos phi specifications	---	(-1.000,-0.800] U [0.800,1.000]		1.000
b) Reactive power fix control						
30	Reactive power	Q specifications	kvar	-0.6·Smax	0.6·Smax	0

Anhang 6 / Annex 6



HUAWEI Huawei Technologies Co., Ltd.

Version: V1.0

No.	Name	Description	Unit	Setting range		Default value (acc. to parameter set)
				Min.	Max.	
c) Q-U characteristic curve ²⁾						
Note:						
²⁾ The Q-U characteristic curve is free programmable with up to 10 supporting points.						
31	Trigger power ratio	Q(U) function trigger power ratio of Pmax	%Pmax	0	100	0
32	Characteristic curve points	Number of Q-U characteristic curve	---	2	10	4
33	U/Un(A)	Q(U) characteristic node 1 U	%Un	80.0	136.0	93
34	Q/S(A)	Q(U) characteristic node 1 Q	/Smax	-0.600	0.600	0.436
35	U/Un(B)	Q(U) characteristic node 2 U	%Un	80.0	136.0	97
36	Q/S(B)	Q(U) characteristic node 2 Q	/Smax	-0.600	0.600	0
37	U/Un(C)	Q(U) characteristic node3 U	%Un	80.0	136.0	103
38	Q/S(C)	Q(U) characteristic node3 Q	/Smax	-0.600	0.600	0
39	U/Un(D)	Q(U) characteristic node3 U	%Un	80.0	136.0	104
40	Q/S(D)	Q(U) characteristic node3 Q	/Smax	-0.600	0.600	-0.436
d) Q-P characteristic curve ²⁾						
Note:						
²⁾ The Q-P characteristic curve is free programmable with up to 10 supporting points.						
41	Characteristic curve points	Number of Q-P characteristic curve	-	2	10	5
42	P/Pmax(A)	Q(P) characteristic node 1 P	%Pmax	0.0	100.0	10.0
43	Q/Smax(A)	Q(P) characteristic node 1 Q	/Smax	-0.600	0.600	0.000
44	P/Pmax(B)	Q(P) characteristic node 2 P	%Pmax	0.0	100.0	50.0
45	Q/Smax(B)	Q(P) characteristic node 2 Q	/Smax	-0.600	0.600	0.000
46	P/Pmax(C)	Q(P) characteristic node 3 P	%Pmax	0.0	100.0	60.0
47	Q/Smax(C)	Q(P) characteristic node 3Q	/Smax	-0.600	0.600	-0.050
48	P/Pmax(D)	Q(P) characteristic node 4 P	%Pmax	0.0	100.0	90.0
49	Q/Smax(D)	Q(P) characteristic node 4 Q	/Smax	-0.600	0.600	-0.330
50	P/Pmax(E)	Q(P) characteristic node 5 P	%Pmax	0.0	100.0	100.0
51	Q/Smax(E)	Q(P) characteristic node 5 Q	/Smax	-0.600	0.600	-0.330
PGU disconnection from the grid-self protection						
52	10 minute OV protection	10 minute voltage average value protection point	p.u	1.00Un	1.5Un	1.1Un

Anhang 6 / Annex 6



HUAWEI Huawei Technologies Co., Ltd.

Version: V1.0

No.	Name	Description	Unit	Setting range		Default value (acc. to parameter set)
				Min.	Max.	
53	10 minute OV protection time	10 minute voltage average value protection time	ms	50	7200000	100
54	Level-1 OV protection	Level 1 over voltage protection point	p.u	1.00Un	1.5Un	1.25 Un
55	Level-1 OV protection time	Level 1 over voltage protection time	ms	50	7200000	100
56	Level-2 OV protection	Level 2 over voltage protection point	p.u	1.00Un	1.5Un	1.25 Un
57	Level-2 OV protection time	Level 2 over voltage protection time	ms	50	7200000	100
58	Level-3 OV protection	Level 3 over voltage protection point	p.u	1.00Un	1.5Un	1.25 Un
59	Level-3 OV protection time	Level 3 over voltage protection time	ms	50	7200000	100
60	Level-1 UV protection	Level 1 under voltage protection point	p.u	0.05Un	1.00Un	0.8 Un
61	Level-1 UV protection time	Level 1 under voltage protection time	ms	50	7200000	3000
62	Level-2 UV protection	Level 2 under voltage protection point	p.u	0.05Un	1.00Un	0.45 Un
63	Level-2 UV protection time	Level 2 under voltage protection time	ms	50	7200000	300
64	Level-1 OF protection	Level 1 over frequency protection point	Hz	50.00	60.00	51.5
65	Level-1 OF protection time	Level 1 over frequency protection time	ms	50	7200000	100
66	Level-2 OF protection	Level 2 over frequency protection point	Hz	50.00	60.00	51.50
67	Level-2 OF protection time	Level 2 over frequency protection time	ms	50	7200000	100
68	Level-1 UF protection	Level 1 under frequency protection point	Hz	40.00	50.00	47.50
69	Level-1 UF protection time	Level 1 under frequency protection time	ms	50	7200000	100
70	Level-2 UF protection	Level 2 under frequency protection point	Hz	40.00	50.00	47.50
71	Level-2 UF protection time	Level 2 under frequency protection time	ms	50	7200000	100
Connection conditions						
72	Auto start upon grid recovery	Enable Auto start upon grid after grid fault	---	Disable/Enable		Enable
73	Grid reconnection voltage upper limit	Limit value connection U>	p.u	Un	1.36Un	1.10Un
74	Grid reconnection voltage lower limit	Limit value connection U<	p.u	0.45Un	Un	0.85Un

Anhang 6 / Annex 6



HUAWEI Huawei Technologies Co., Ltd.

Version: V1.0

No.	Name	Description	Unit	Setting range		Default value (acc. to parameter set)
				Min.	Max.	
75	Grid reconnection frequency upper limit	Limit value connection $f >$	Hz	50.00	60.00	50.10
76	Grid reconnection frequency lower limit	Limit value connection $f <$	Hz	40.00	50.00	47.50
77	Max. voltage of grid-tied startup	Limit value connection $U >$	p.u	U_n	1.36 U_n	1.10 U_n
78	Min. voltage of grid-tied startup	Limit value connection $U <$	p.u	0.45 U_n	U_n	0.85 U_n
79	Max. frequency of grid-tied startup	Limit value connection $f >$	Hz	50.00	60.00	50.10
80	Min. frequency of grid-tied startup	Limit value connection $f <$	Hz	40.00	50.00	47.5
Response during grid faults						
81	LVRT	LVRT enable	---	Enable/Disable		Enable
82	LVRT triggering threshold	LVRT triggering threshold	p.u	0.50 U_n	1.00 U_n	0.80 U_n
83	LVRT reactive power compensation factor	k factor	---	0.0	10.0	2.0
84	HVRT	HVRT enable	---	Enable/Disable		Enable
85	HVRT triggering threshold	LVRT triggering threshold	V	1.00 U_n	1.36 U_n	1.20 U_n
86	HVRT reactive power compensation factor	k factor	---	0.0	10.0	2.0
87	VRT exit hysteresis threshold	VRT exit hysteresis threshold	p.u	0.02 U_n	0.1 U_n	0.05 U_n
88	Grid voltage protection shield during HVRT/LVRT	Grid voltage protection shield during HVRT/LVRT	---	Enable/Disable		Disable
89	Zero current due to power grid fault	Zero current due to power grid fault	---	Enable/Disable		Disable
90	Grid voltage jump triggering threshold	Grid voltage jump triggering threshold	% U_n	0.0	30.0	5.0
LVRT Characteristic Curve						

Anhang 6 / Annex 6



HUAWEI Huawei Technologies Co., Ltd.

Version: V1.0

No.	Name	Description	Unit	Setting range		Default value (acc. to parameter set)
				Min.	Max.	
91	Characteristic Curve points	Number of LVRT characteristic curve points	-	2	10	5
92	t(A)	LVRT characteristic node 1 t	ms	0	60000	0
93	U(A)	LVRT characteristic node 1 U	%Un	0	100	100
94	t(B)	LVRT characteristic node 2 t	ms	0	60000	0
95	U(B)	LVRT characteristic node 2 U	%Un	0	100	15
96	t(C)	LVRT characteristic node 3 t	ms	0	60000	150
97	U(C)	LVRT characteristic node 3 U	%Un	0	100	15
98	t(D)	LVRT characteristic node 4 t	ms	0	60000	3000
99	U(D)	LVRT characteristic node 4 U	%Un	0	100	85
Self-protection						
100	Line voltage peak value protection point	Line voltage peak value protection point, exceeds which a non-delayed self-protection tripping occurs	V	parameter not adjustable		1.50U _n

Anhang 7 / Annex 7

**Erklärung zur Konformität mit den NAR/
Statement conformity with the GCR**



HUAWEI Huawei Technologies Co., Ltd.

Version: V1.0

Manufacturer declaration

Date	Revised Revision	Description	Author
2023.01.10	V1.0	Released	SongPengfei

Family : SUN2000-50KTL-M3

Manufacturer Huawei Technologies Co.,Ltd. Confirms that the PGUs (SUN2000-50KTL-M3) have been designed to meet the requirements raised by this guideline (VDE-AR-N 4110: 2018 / VDE-AR-N 4120: 2018).

Signature: *Song Pengfei*

Date: 2023-01-10