

FIMER

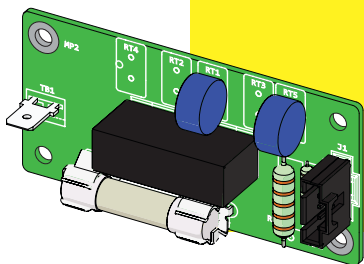

Solar Inverter PVS-100/120 GROUNDING KIT

Quick Installation Guide

1. Functionalities

The grounding kit allows to connect the negative input pole of the PV array to ground (where is required by technical data of the PV modules).

2. Main components

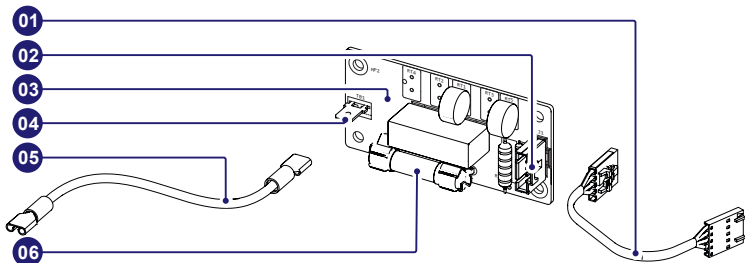

Main components

- | | |
|----|--------------------------------|
| 01 | Wiring signals |
| 02 | Wiring signals connector |
| 03 | Negative grounding board |
| 04 | Negative pole connection point |
| 05 | Wiring negative pole |
| 06 | Grounding fuse |

3. Supplied component list

Components available in the kit

Quantity

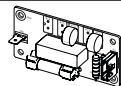

Negative grounding board

1



Wiring negative pole. Based on the inverter model, two wiring with different length are available:

- Code on the wiring ZLH.V3R06.0 = 750mm
- Code on the wiring ZLH.V3R05.0 = 60mm

2

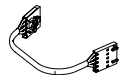

Wiring signals.

1





Standoffs (male/female) for mechanically installing

2



M4x14 screws for mechanically securing the grounding board to the wiring box

2

	Warning label	3
	AC overvoltage surge arresters (SPD_440VAC_40KA_3P+1)	1
	Technical documentation	1

4. Assembly instructions

⚠ WARNING – Access to the zones inside the inverter must be carried out with the equipment disconnected from the network and from the photovoltaic generator. Perform the "Inverter total de-energization and safe access" procedure described in the inverter product manual.

⚠ WARNING – If this accessory is installed this inverter must be installed and operated in restricted areas (restricted area: Room or location for electrical equipment to which access is restricted to skilled or instructed persons by the opening of a door or the removal of a barrier by the use of a key or tool and which is clearly marked by appropriate warning signs). Access is limited to qualified personnel (qualified personnel: A person having appropriate technical training and experience necessary to be aware of hazards to which that person may be exposed in performing a task and of measures to minimize the risks to that person or other persons).

⚠ ATTENTION – The maximum current flowing to earth, in case of ground fault on the DC side of the plant will be less than Nx1000mA (PVS-100) or Nx1200mA (PVS-120) where N is the number of inverters connected to the same transformer winding. This current value must be considered to size the wires and to evaluate the risk of fire.

⚠ ATTENTION – The earth protection circuit (PE) of the PV plant must have the same potential of the earth protection circuit (PE) of the building (in case of roof-top installation).

⚠ WARNING – The extraneous conductive parts of the building and the earthed conductive parts of the plant must not be accessible simultaneously.

⚠ ATTENTION – It is not recommended to use the grounding kit in buildings with high risk of fire.

⚠ WARNING – It is not recommended to use the grounding kit in buildings with LPS (lightning protection systems) to avoid potential differences among different earthed conductive parts of the PV plant that people can touch. Restricted access to PV plant reduces this hazard.

4.1 Opening the wiring box cover

- Perform the "Inverter total de-energization and safe access" procedure described in the inverter product manual.
- Use the key tool (provided with the installation kit contained in the wiring box package) to open the three cover quarter cam locks (05) following the proper rotation as shown in the related silkscreens on the wiring box cover (07).

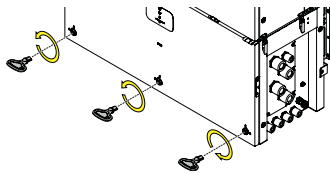

- Open the wiring box cover (07) and use the cover support brackets (14) to lock the cover (07) in open position.

⚠ ATTENTION – Pay attention to properly secure the cover support brackets (14) in order to avoid falling of the cover!

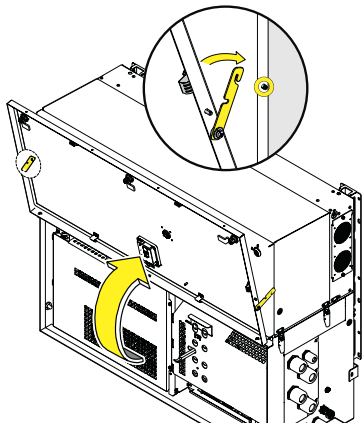

4.2 AC SPD replacement

With the installation of negative grounding kit the AC overvoltage SPD (22) (and its configuration) must be replaced.

- Remove the AC protective shield (27) by removing the M5 screw in order to be able to work on the AC overvoltage SPD (22).

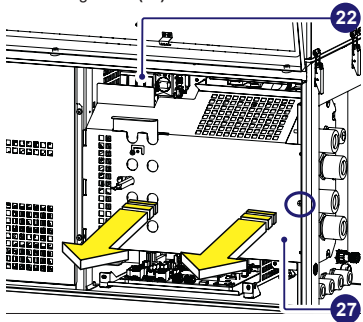

Original AC SPD configuration

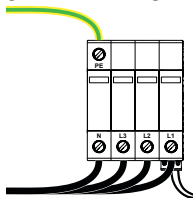

- Unscrew the 5 cables (PE+N+L1+L2+L3) and disconnect the signal connector from the AC overvoltage SPD.
- Replace the original SPD with the new one (SPD_440VAC_40KA_3P+1) supplied with the grounding kit.

SPD replacement

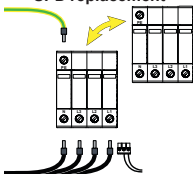

- Reinstall the 5 cables and the signal connector. The position of PE (protective earth) and N (neutral) cables must be switched to each other.

AC SPD configuration for grounding kit

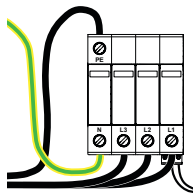

⚠ ATTENTION – The cables must be installed with a tightening torque of 4.0 Nm.

4.3 Grounding board installation

The installation of the negative grounding board can be done in 2 different ways based on the the wiring box model

4.3.1 Installation procedure on 1/2 MPPTs wiring box:

- Remove the internal DC Protective shields (60) by removing the six M5 screws. Remove firstly the lower shield (in yellow) and the upper one after (in green).

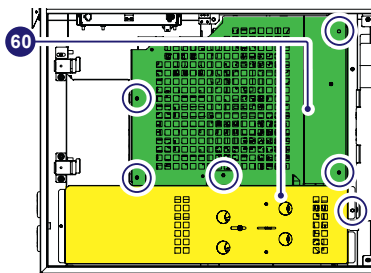

- Install the grounding board:
 - install the two standoffs (supplied in the kit).
 - Install the board on the two retain pins and lock it in position using the two M4 screws (supplied in the kit).

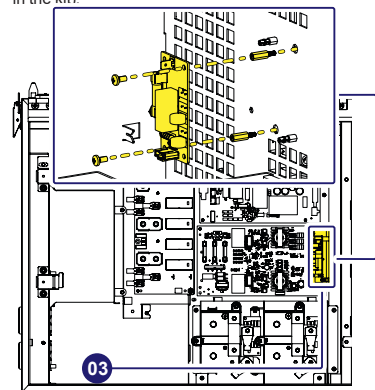

- Unscrew the two fixing screws and extract the slide where the communication and control board (28) is installed.
- Connect the wiring signals (01):
 - one side on the wiring signals connector (02) of the grounding board (03).

- other side on J34 of the communication and control board (28).

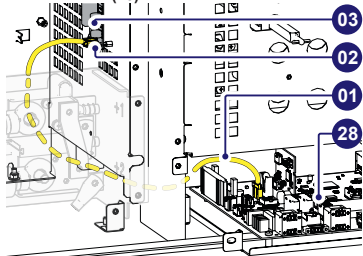

NOTE – The wiring must be passed through the bottom of the partition (DC side / AC side of the wiring box) together with the other cables present on the wiring box

- Connect the wiring negative pole (05) (wiring code ZLH.V3R06):
 - one side on the negative pole connection point (04) of the grounding board (03).
 - other side on TB1 of SPD board (V2Q62).

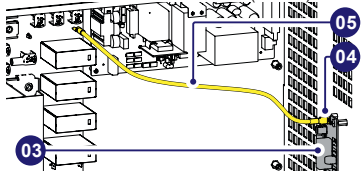

4.3.2 Installation procedure on 6 MPPTs wiring box:

- Remove the internal DC Protective shield (60) (in yellow) by removing the two M5 screws.

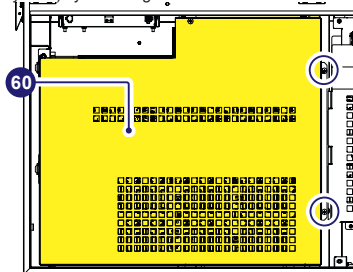

- Install the grounding board:
 - install the two standoffs (supplied in the kit).
 - Install the board on the two retain pins and lock it in position using the two M4 screws (supplied in the kit).

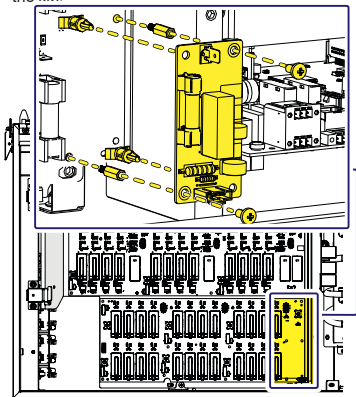

- Unscrew the two fixing screws and extract the slide where the communication and control board is installed (28).
- Connect the wiring signals (01) :
 - one side on the wiring signals connector (02) of the grounding board (03).
 - other side on J34 of the communication and control board (28)

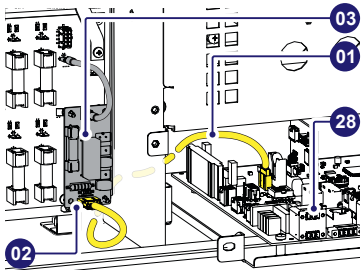

NOTE – the wiring must be passed through the bottom of the partition (DC side / AC side of the wiring box) together with the other cables present on the wiring box.

- Connect the wiring negative pole (05) (wiring code ZLH.V3R05):
 - one side on the negative pole connection point (04) of the grounding board (03).
 - other side on TB13 of the negative fuses board.

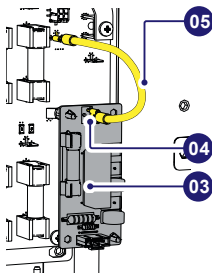

4.4 Final installation operations

- At the end of installation reinstall the two DC protective shields (60) and close the wiring box cover (07)
- Stick the warning label supplied with the kit near to the certification label of the wiring box:

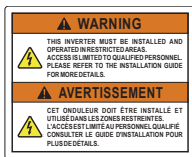

5. Commissioning

Perform the following procedure (described in the product manual of the inverter) in order to commissioning the inverter.

- Close the DC disconnect switches (15) to supply the inverter with input voltage from the photovoltaic generator
- Close the AC switch downstream of the inverter (and AC disconnect switch (09) in the version of wiring box where is present).

• When the input voltage is sufficient to allow the connection to the grid, the inverter will check the grid voltage, measure the isolation resistance of the photovoltaic field with respect to ground and performs other auto-diagnostic checks. During the preliminary checks on the parallel connection with the grid, the "Power" LED keeps flashing, the "Alarm" and "GFI" LEDs are OFF. The inverter will ONLY connect to the grid if all parameters fall within the ranges foreseen by current regulations.

• If the outcome of the preliminary checks to grid synchronization are positive, the inverter connects and starts to export power to the grid. The "Power" LED remains fixed on while the "Alarm" and "GFI" LEDs are OFF.

• To access to the Web User Interface is required to connect a device equipped with wireless connection (such as tablet, laptop or smartphone). Enable the wireless connection on the device (tablet, smartphone or laptop) and connect it to the Access Point created by the inverter system: the name of the wireless network created by the inverter that the connection should be established with, will be:

ABB-XX-XX-XX-XX-XX-XX

where "X" is a hex digit of the MAC address (MAC address can be found on the "Communication Identification label" placed on the side of the inverter or applied during the commissioning phase to the plant documentation).

• When required digit the PRODUCT KEY (printed on the "Communication Identification label" and applied during the commissioning phase to the plant documentation) as access point password.

NOTE – It's required to digit also the dash "-" characters of the Product Key in the password field.

NOTE – In case of need, product key can be recovered by Aurora Vision Cloud or by calling Fimer technical support.

• Open an internet browser (reccomended browser: Chrome versions from v.55, Firefox versions from v.50) and enter the pre-set IP address 192.168.117.1 to access the login page.

• Enter the Menu "Setting/Additional Function".

NOTE – To enable this menu entering in the Web UI using the Admin plus privileges.

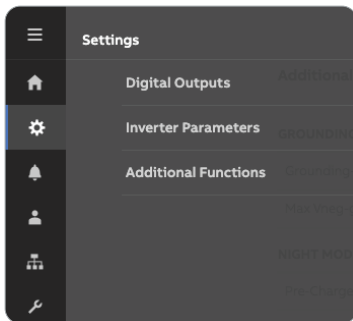

• Set as ENABLED the Grounding Kit (if is installed as an accessory on the field) with the proper selector.

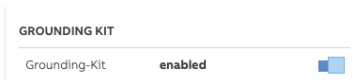

• Set the "Max Vneg-gnd for Grounding Kit" (range: 0...250V); recommended value: 200V.



ATTENTION – This parameter identifies the threshold voltage between negative pole and ground, which triggers the inverter disconnection for Ground fault (E037).

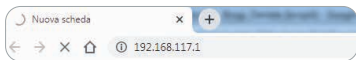

6. Technical data

Main components

Grounding kit

Compatibility PVS-100/120-TL "B2 Version" (all models)

In the model name the "B2" suffix must be present (see the identification labels).



Type of grounding Resistive

Pole connected to the PE Negative

System requirements

Isolating transformer	Mandatory ¹⁾ -IT System-
Configuration of the isolating transformer	Delta or wye configuration on the inverter side, can be used, but transformer poles, including star center point (neutral), cannot be connected/referred to ground
Configuration of the photovoltaic strings	If the system has multiple inverters connected to the same transformer, all strings must be of the same panel type, number of panels in series and orientation.
Maximum number of inverters that can be connected in parallel on a single winding of transformer:	
Nominal power of the transformer	1000 kVA 1250 kVA 1600 kVA 2000 kVA 2500 kVA
Maximum number of PVS-100-TL B2 version	10 12 16 20 25
Maximum number of of PVS-120-TL B2 version	8 10 13 16 21

1. NOT SUITABLE for single-or multi-inverter systems that are directly connected to the low voltage network.

The features that are not specifically mentioned in this data sheet are not included in the product

FIMER_PVS-100_120 GROUNDING KIT_Quick Installation Guide_EN_RevA 09-09-2020

For more information please contact your local FIMER representative or visit:

fimer.com

We reserve the right to make technical changes or modify the contents of this document without prior notice. With regard to purchase orders, the agreed particulars shall prevail. FIMER does not accept any responsibility whatsoever for potential errors or possible lack of information in this document.

We reserve all rights in this document and in the subject matter and illustrations contained therein. Any reproduction, disclosure to third parties or utilization of its contents – in whole or in parts – is forbidden without prior written consent of FIMER. Copyright© 2020 FIMER. All rights reserved.