



PV Master APP



SEMS Portal APP



SEMS Portal website
www.semsportal.com



LinkedIn



Company's
official website



GOODWE
YOUR SOLAR ENGINE



JIANGSU GOODWE POWER SUPPLY TECHNOLOGY CO.,LTD

No. 90 Zijin Rd., New District, Suzhou, 215011, China

www.goodwe.com

service@goodwe.com



340-00310-01

BH SERIES USER MANUAL

HYBRID INVERTER

TABLE OF CONTENTS

01 INTRODUCTION

1.1 Operation Modes Introduction	01
1.2 Safety & Warning	02
1.3 Product Overview	04

02 INSTALLATION INSTRUCTIONS

2.1 Unacceptable Installations	05
2.2 Packing List	05
2.3 Mounting	06
2.3.1 Select Mounting Location	06
2.3.2 Mounting	07
2.4 Electrical Wiring Connection	09
2.4.1 Battery Wiring Connection	09
2.4.2 On-Grid & Back-Up Connection	10
2.4.3 Smart Meter & CT Connection	13
2.5 DRED / Remote Shutdown Connection	15
2.6 Earth Fault Alarm Connection	16

03 MANUAL OPERATION

3.1 Wi-Fi Configuration	19
3.2 PV Master App	20
3.3 CEI Auto-Test Function	20

04 OTHERS

4.1 Error Messages	21
4.2 Troubleshootings	23
4.3 Disclaimer	27
4.4 Technical Parameters	28
4.5 Other Test	29
4.6 Quick Check List To Avoid Danger	30

01 INTRODUCTION

GoodWe BH series bidirectional inverter is designed for both indoor and outdoor use, which could be used with or without existing grid-tied inverter systems to store energy using batteries.

Energy produced from the grid-tied inverters will be used to optimize self-consumption, excess will be used to charge the battery, anymore could be exported to the grid. Loads will be supported in priority by grid-tied system, then battery power, if more power is needed, energy will be imported from the grid.

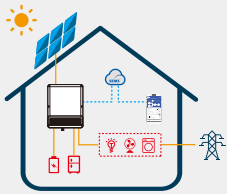

Note:
The introduction describes a general behavior of BH system. The operation mode can be adjusted on PV Master App depending on the system layout. Below are the general operation modes for BH system:

1.1 Operation Modes Introduction

BH system normally has the following operation modes based on your configuration and layout conditions.

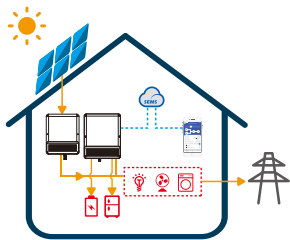

Mode I

Energy from grid-tied inverters optimize loads, excess will be used to charge the battery, anymore will be exported to the grid.

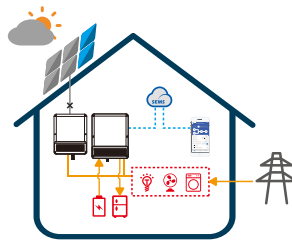

Mode II

When energy from grid-tied inverters is weak, battery will discharge to support the load in priority together with the grid.

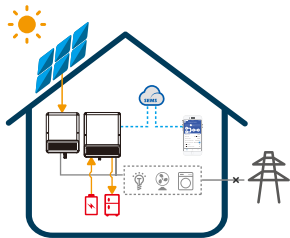

Mode III

When grid power fails, battery will discharge to support back-up loads.

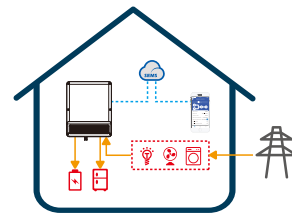

Mode IV

Battery could be charged by grid, and charge time/power could be set flexibly on PV Master App.

1.2 Safety & Warning

The BH series inverter of Jiangsu GoodWe Power Supply Technology Co., Ltd. (hereinafter called as GoodWe) strictly complies with related safety rules for product design and testing. Please read and follow all the instructions and cautions on the inverter or user manual during installation, operation or maintenance, as any improper operation might cause personal or property damage.

Symbols Explanation



Caution!
Failure to observe a warning indicated in this manual may result in injury



Danger of high voltage and electric shock!



Danger of hot surface!



Components of the product can be recycled.



This side up! The package must always be transported, handled and stored in such a way as the arrows always point upwards.



No more than six (6) identical packages being stacked on each other.



Products should not be disposed as household waste.



Fragile - The package/product should be handled carefully and never be tipped over or slung.



Refer to the operating instructions.



Keep dry! The package/product must be protected from excessive humidity and must be stored under cover.



Signals danger due to electric shock and indicates the time to wait (5 minutes) before it is safe to touch the internal parts of the inverter after it has been disconnected from its power source



CE Mark

Safety Warning

Any installation and operation on inverter must be performed by qualified electricians, in compliance with standards, wiring rules or requirements of local grid authorities or companies (like AS 4777 and AS/NZS 3000 in Australia).

Prohibit to insert or pull the AC and DC terminals when the inverter is running.

Before any wiring connection or electrical operation on inverter, all battery and AC power must be disconnected from inverter for at least 5 minutes to make sure inverter is totally isolated to avoid electric shock.

The temperature of inverter surface might exceed 60°C during working, so please make sure it is cooled down before touching it, and make sure the inverter is untouchable for children

Do not open inverter cover or change any components without GoodWe's authorization, otherwise the warranty commitment for the inverter will be invalid.

Usage and operation of the inverter must follow instructions in this user manual, otherwise the protection design might be useless and warranty for the inverter will be invalid.

Appropriate methods must be adopted to protect inverter from static damage. Any damage caused by static is not warranted by GoodWe.

The inverter, with built-in RCMU, will exclude possibility of DC residual current to 6mA, thus in the system an external RCD (type A) can be used($\geq 30\text{mA}$).

In Australia, the inverter internal switching does not maintain neutral integrity, which must be addressed by external connection arrangements like in the system connection diagram for Australia on page 16.

In Australia, output of Back-Up side in switchbox should be labeled "Main switch UPS supply", the output of normal load side in switch box should be labeled "main switch inverter supply".

1.3 PRODUCT OVERVIEW

HYBRID LED INDICATORS		
INDICATOR	STATUS	EXPLANATION
SYSTEM		ON = SYSTEM IS READY
BACK-UP		BLINK = SYSTEM IS STARTING UP
BATTERY		OFF = SYSTEM IS NOT OPERATING
GRID		ON = BACK-UPS READY / POWER AVAILABLE
ENERGY		OFF = BACK-UPS IS OFF / ON POWER AVAILABLE
COM		ON = BATTERY IS CHARGING
WiFi		BLINK1 = BATTERY IS DISCHARGING
FAULT		BLINK2 = BATTERY IS LOW / SOC IS LOW
		OFF = BATTERY IS DISCONNECTED / NOT ACTIVE
		BLINK1 = GRID IS ACTIVE AND CONNECTED
		BLINK2 = BATTERY IS LOW / SOC IS LOW
		OFF = BMS AND METER COMMUNICATION FAIL
		ON = CONSUMING ENERGY FROM GRID / BURNING
		BLINK1 = SUPPLYING ENERGY TO GRID / ZEROING
		OFF = GRID IS NOT CONNECTED OR SYSTEM NOT OPERATING
		ON = BMS AND METER COMMUNICATION OK
		BLINK1 = METER COMMUNICATION OK, BMS COMMUNICATION FAIL
		BLINK2 = METER COMMUNICATION FAIL, BMS COMMUNICATION OK
		OFF = BMS AND METER COMMUNICATION FAIL
		ON = WiFi CONNECTED / ACTIVE
		BLINK1 = WiFi SYSTEM RESETTING
		BLINK2 = WiFi NOT CONNECT TO ROUTER
		BLINK4 = WiFi SERVER PROBLEM
		OFF = WiFi NOT ACTIVE
		ON = FAULT HAS OCCURRED
		BLINK1 = OVERLOAD OF BACK-UP OUTPUT / REDUCE LOAD
		OFF = NO FAULT

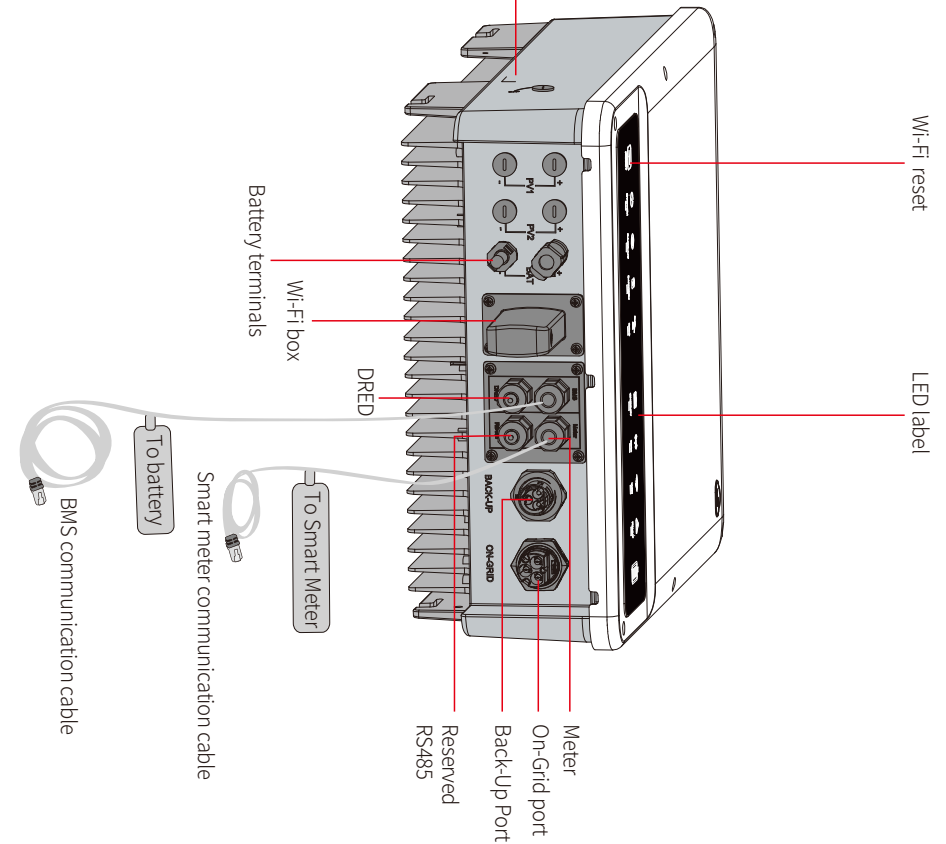

2.1 UNACCEPTABLE INSTALLATIONS

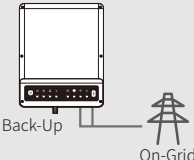
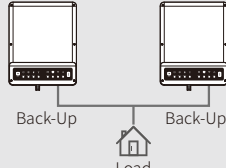
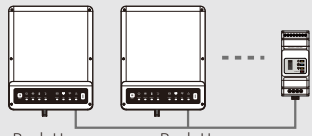
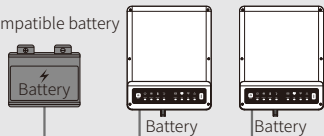
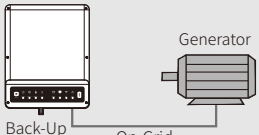
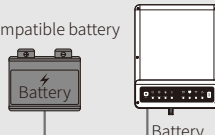
 <p>Back-up cannot connect to grid</p>	 <p>Back-up cannot connect in parallel</p>
 <p>One meter cannot connect to multi inverters, and different CT cannot connect to a smart fier cable</p>	 <p>One battery bank cannot be connected to multi inverters</p>
 <p>On-Grid or back-up side cannot connect to any ac generator.</p>	 <p>Inverter battery input cannot connect to incompatible batteries.</p>

2.2 Packing List

On receiving the BH series inverter, please check to make sure all the components as below are not missing or broken.

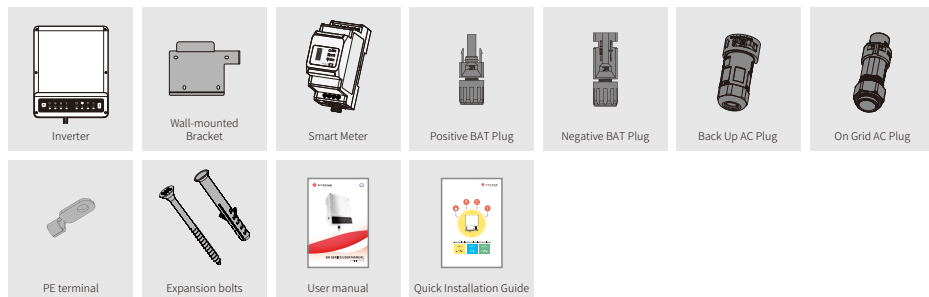

2.3 Mounting

2.3.1 Select Mounting Location

For inverter's protection and convenient maintenance, mounting location for inverter should be selected carefully based on the following rules:

Any part of this system shouldn't block the switch and breaker to disconnected inverter from DC and AC power.

Rule 1. Inverter should be installed on a solid surface, where is suitable for inverter's dimensions and weight.

Rule 2. Inverter installation should stand vertically or lie on a slop by max 15°

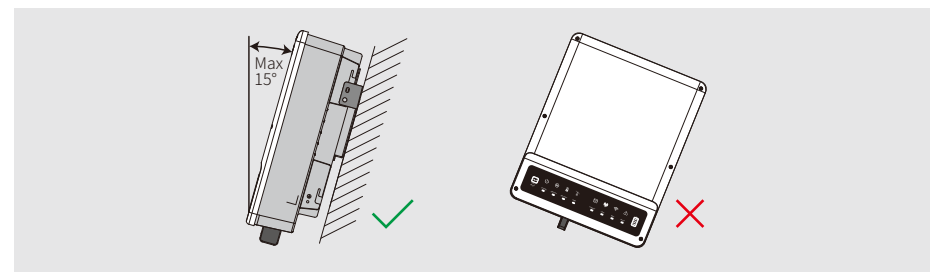

Rule 3. Ambient temperature should be lower than 45°C (High ambient temperature will cause power derating of inverter)

Rule 4. The installation of inverter should be protected under shelter from direct sunlight or bad Rule weather like snow, rain, lightning etc.

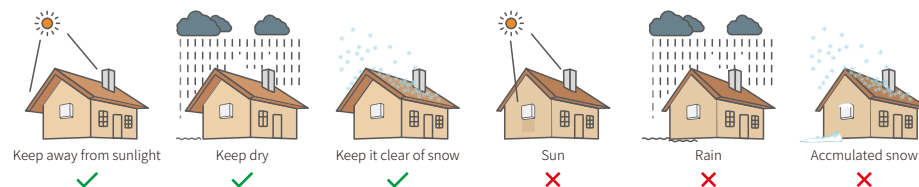

Rule 5. Inverter should be installed at eye level for convenient maintenance.

Rule 6. Product label on inverter should be clearly visible after installation.

Rule 7. Leave enough space around inverter following the values.

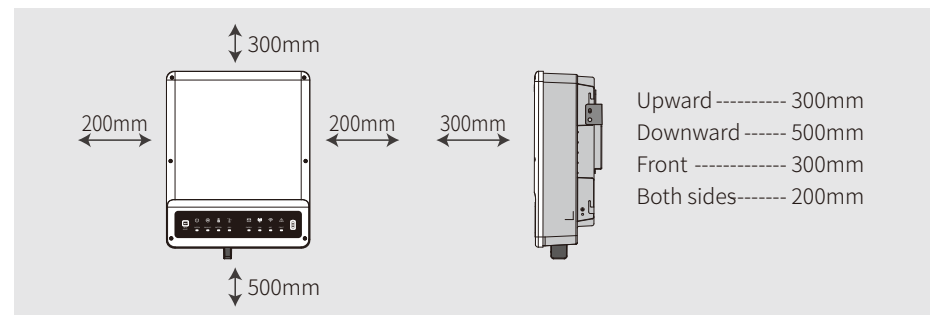

 Inverter cannot be installed near flammable, explosive or strong electro-magnetic equipment.[1]

2.3.2 MOUNTING

 Inverter cannot be installed near flammable, explosive or strong electro-magnetic equipment.[1]

The inverter is suitable for mounting on concrete or other non-combustible surface only.

Step 1

- Please use the mounting bracket as a template to drill 4 holes on right positions (10mm in diameter, and 80mm in depth)
- Use expansion bolts in accessory box and fix the mounting bracket onto the wall tightly

Note: Bearing capacity of the wall must be higher than 25kg, otherwise may not be able to keep inverter from dropping.

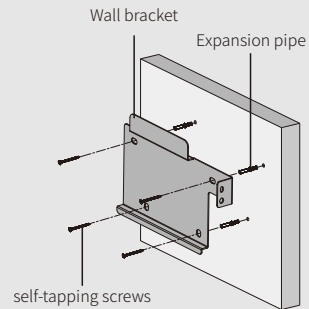
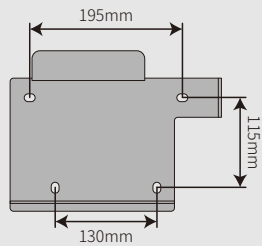

Step 2

Carry the inverter by holding the heating sink on two sides and place the inverter on the mounting bracket.

Note: Make sure the heat sink on inverter is right joint with mounting bracket.

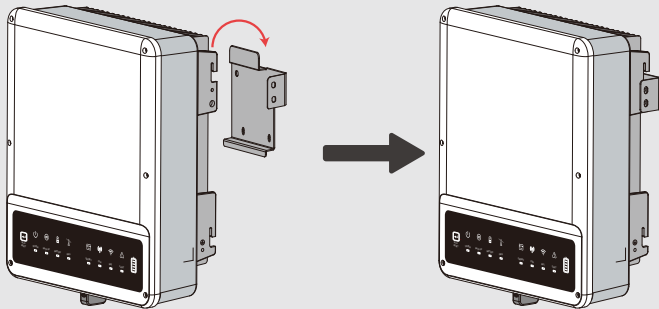

Step 3

Ground cable must be connected to ground plate on grid side.

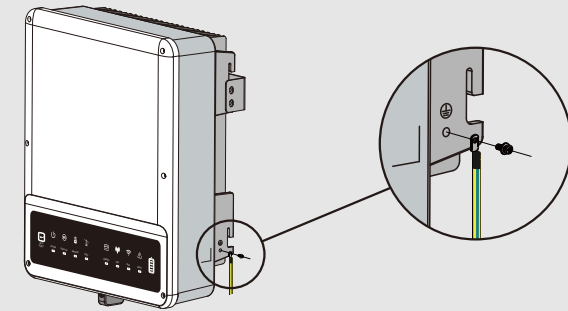

Step 4

A lock could be used for anti-theft if it is necessary for individual requirement.

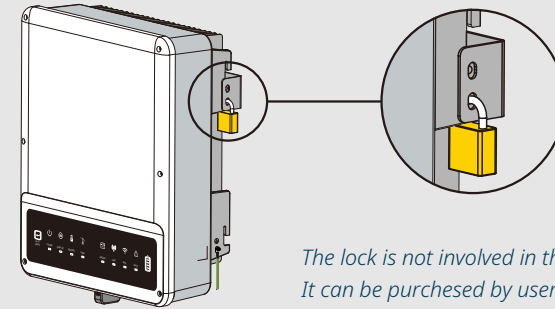

The lock is not involved in the package, It can be purchased by user.

2.4 Electrical Wiring Connection

2.4.1 Battery Wiring Connection

- Please be careful against any electric shock or chemical hazard.
- Make sure there is an external DC breaker ($\geq 40A$) connected for battery without build-in DC breaker.



Make sure battery breaker is off and battery nominal voltage meet BH specification before connecting battery to inverter and make sure inverter is totally isolated from AC power.

Please following the steps as bellow strictly. Use improper wire may cause bad contact and high impedance, which is dangerous to the system.

- Use the right BAT plugs in the accessory box.
- Use the tin-plated cables with a conductor cross section of 4 to 6 mm² (AWG 10) because the maximum battery current is 25A (for BH3.6-6kW) and 32A (for BH3kW). Battery cable requirements are shown as below.

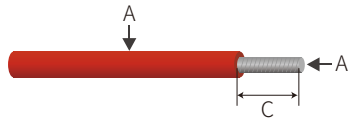

Grade	Description	Value
A	Outside diameter insulation	5.5-8.0 mm
B	Conductor core section	4-6 mm ²
C	Conductor core length	7 mm

Step 1

Prepare BAT cables and BAT plugs

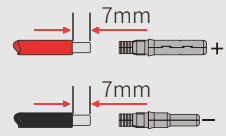

Note

- Please use BAT plugs and connectors in the accessory box.
- BAT cable should be standard, 4-6mm² BAT cable.

Step 2

Connect BAT cables to BAT connectors

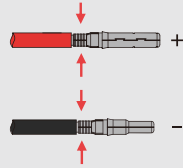

Note

- BAT cable must be tightly crimped into the connectors.
- For Amphenol connector, the limit buckle cannot be pressed.
- There will be a click sound if connectors are inset correctly into BAT plugs.

Step 3

Screw the cap on and plug onto inverter side

Note: There will be a click sound if connectors are inset correctly into BAT plugs.

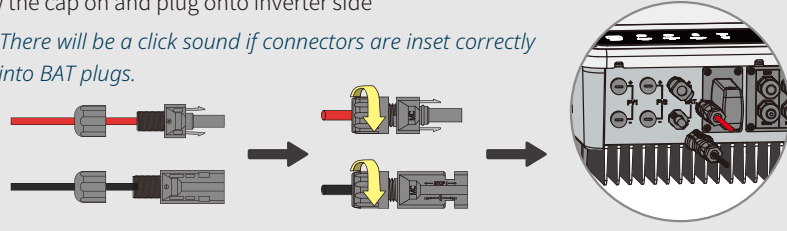

Note: For the compatible lithium batteries (Pylon/BYD) connection, please refer to battery connection part in BH quick installation instructions.

2.4.2 On-Grid & Back-Up Connection

An external AC breaker is needed for On-Grid connection to be isolate from grid when necessary. Below are the requirements of On-Grid AC breaker.

Inverter Model	AC Breaker Specification
GW3K-BH	50A/230V AC breaker
GW3600-BH	50A/230V AC breaker
GW5000-BH	63A/230V AC breaker
GW6000-BH	63A/230V AC breaker

1. Use separated AC breaker for individual inverter
2. On AC side, the individual breaker should be connected before loads "between inverter and loads".

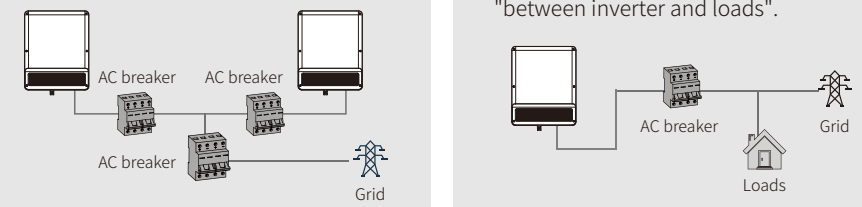

Requirement of AC cable connected to On-Grid and Back-Up side



Make sure inverter is totally isolated from any DC or AC power before connecting AC cable.

Note:

- The choice of AC cable needs to meet both the outside diameter and conduct core section requirements. Please refer to the table for selecting the AC cable.
- Neutral cable shall be blue, line cable is black or brown (preferred) and protective earth cable yellow-green.
- For AC cables, PE cable shall be longer than N&L cables, so that if in any case AC cable slips or taken out, the protecting earth conductor will be the last to take the strain.

On-Grid wiring connection process is as below

Step 1

Prepare the AC cable according to the table.

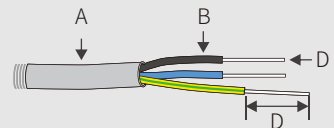

Grade	Description	Value
A	Outside diameter	13-22 mm
B	Separated wire length	10-15 mm
C	Conductor wire length	12-14 mm
D	Conductor core section	8-10 mm ²

Note: If you don't use the Back-Up function or use on-grid power to charge the battery, the wiring conduct core section can use 4-6mm².

Step 1

1. Prepare the terminals AC cables.
2. Put AC cable through terminal cover and screw the three cables tightly on the connectors.

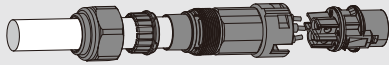

Note:

- Please use the terminals in components box;
- Make sure cable jacket is not locked with conductor.

Step 2

Lock terminal cover and screw up the terminal cap.

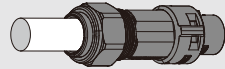

Note:

- BAT cable must be tightly crimped into the connectors
- For Amphenol connector, the limit buckle cannot be pressed
- There will be a click sound if connectors are inset correctly into BAT plugs

Step 2

1. Prepare the terminals AC cables.
2. Put AC cable through terminal cover and screw the three cables tightly on the connectors.

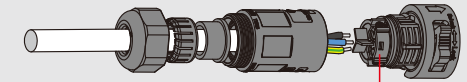

Torque 0.7-0.9N.m

Step 3

Lock terminal cover and screw up the terminal cap.

Unlock → lock



Make sure the terminal cover is locked up here.

Note: Make sure the terminal cover is rightly locked onto the terminal.

Step 4

Connect the assembled AC terminals onto inverter.

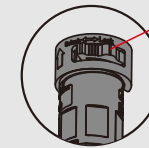

Press the button and hold it to unlock when unplugging AC terminals.

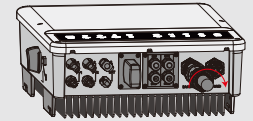

Note: Make sure it is connected to "Back-Up" side (other side connected to public grid).

Step 3

1. Connect the assembled AC terminals onto inverter.

Note: Make sure it is connected to "On-Grid" side (other side connected to public grid).

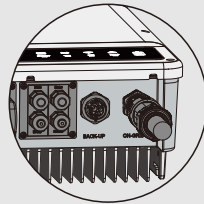

Special Adjustable Setting

The inverter has filed adjustable setting like tripping point, tripping time, reconnect time, active and invalid of QU/PU curves etc. by special firmware. Please contact GoodWe after sales for the special firmware and adjust methods.

Declaration For Back-Up Function

The back-up output of BH hybrid inverters have over load ability.

For details please refer to the technical parameters of BH series inverter section (Page **).

And the inverter has self-protection derating at high ambient temperature.

The below statement lays out general policies governing the energy storage inverters of the series EH, EM, ES, ET, BH, BT and SBP.

1. For Hybrid inverters (Series ES, EM, EH and ET), the standard PV installation typically consists of the connection of the inverter with both panels and batteries. In case of systems not connected to the batteries, the Back-Up function is strongly not advised to use. GoodWe shall not cover the standard warranty and be liable for any consequences arising from users not following this instruction.
2. Under normal circumstances, the Back-Up switching time is less than 10 ms (the minimal condition to be considered as the UPS level). However, some external factors may cause the system to fail on Back-Up mode. As such, we recommend the users to be aware of conditions and follow the instructions as below:
 - Do not connect loads if they are dependent on a stable energy supply for a reliable operation

Back-Up wiring connection process is as below

Step 1

Prepare the AC cable according to the table.

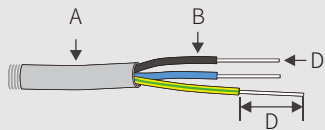

Grade	Description	Value
A	Outside diameter	10-14 mm
B	Separated wire length	7-10 mm
C	Conductor wire length	7-9 mm
D	Conductor core section	4-6 mm ²

An external AC breaker ($\geq 32A$) is needed for Back-Up connection to be isolate when necessary.

Note: The absence of AC breaker on Back-Up side will lead to inverter damage if only electrical short-circuit happened on Back-Up side. And Back-Up function cannot turn off under On-Grid condition.

- Do not connect the loads which may in total exceed the maximum Back-Up capacity
- Try to avoid those loads which may create very high start-up current surges such as Inverter Air-conditioner, high-power pump etc.
- Due to the condition of battery itself, battery current might be limited by some factors including but not limited to the temperature, weather etc.

Accepted Loads As Below:

BH series hybrid inverters are able to supply over load output at it's Back-Up. For details please refer to the technical parameters of BH series inverter (4.3 section). And the inverter has self-protection derating at high ambient temperature.

- Inductive Load: 1.5P non-frequency conversion air-conditioner can be connect to back-up side. Two or more non-frequency conversion air-conditioner connect to Back-Up side may cause UPS mode unstable.
- Capacitive Load: Total power $\leq 0.6 \times$ nominal power of model. (Any load with high inrush current at start-up is not accepted.)
- For complicated application, please contact after-sales.

Note:

For a convenient maintenance, an DP3T support could be installed on Back-Up and On-Grid side. Then it is adjustable to support load by Back-Up or by grid or just leave it there.

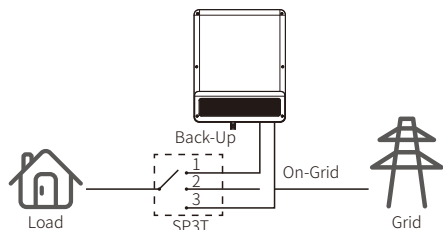

1. Back-up load is supplied from back-up side.
2. Back-up load is isolated.
3. Back-up load is supplied from grid side.

Declaration For Back-Up Overload Protection

Inverter will restart itself as overload protection happens. The preparation time for restarting will be longer and longer (max one hour) if overload protection repeats. Take following steps to restart inverter immediately.

- Decrease Back-Up load power within max limitation.
- On PV Master → Advanced Setting → Click "Reset Back-Up Overload History"

2.4.3 Smart Meter & CT Connection

The single-phase Smart Meter with 2 CTs in product box is compulsory for BH system installation, used to detect grid voltage and current direction and magnitude, further to instruct the operation condition of BH inverter via RS485 communication.



Make sure BH and grid-tied inverters are totally isolated from AC and DC power before connecting Smart Meter and CT

Smart Meter Wiring connection diagram

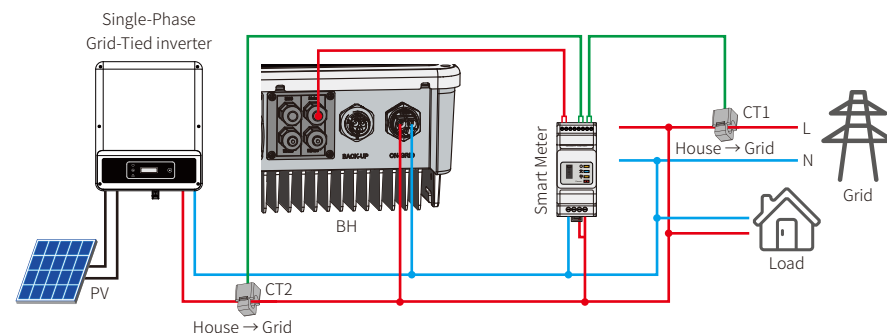

Note:

1. The Smart Meter and CT is well configured, please do not change any setting on smart meter.
2. CT must be connected on the same phase with smart meter power cable.
3. Please use the Smart Meter with CT in product box.
4. CT cable is 3m as default, could be extended to max 5m.
5. Smart Meter communication cable (RJ45) is attached on the inverter ("To Smart Meter" cable), could be extended to max 100m, and must use standard RJ45 cable and plug, as the diagram:

Detailed Pin Function Of Each Port On BH

BMS: CAN communication is configured by default. If 485 communication is used, please contact after-sales to replace with the corresponding communication line.

Position	Color	BMS Function	Smart Meter Function	EMS
1	Orange&white	485_A2	NC	485_A
2	Orange	NC	NC	485_B
3	Green&white	485_B2	485_B1	485_A
4	Blue	CAN_H	NC	NC
5	Blue&white	CAN_L	NC	NC
6	Green	NC	485_A1	485_B
7	Brown&white	NC	485_B1	NC
8	Brown	NC	485_A1	NC



Smart Meter LED Indications

STATUS	OFF	ON	Blinking
POWER	Not working	Working	/
ENERGY	/	Importing	Exporting
COM	Blink one time when it transfer data to inverter		

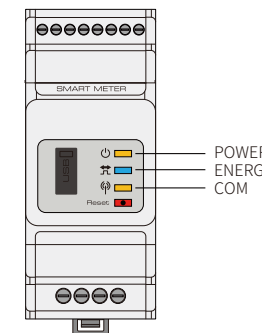

Make sure AC cable is totally isolated from AC power before connecting Smart Meter & CT.

The Smart Meter with CT in product box is compulsory for BH system installation, used to detect grid voltage and current direction and magnitude, further to instruct the operation condition of BH inverter via RS485 communication.

Note:

1. The Smart Meter with CT is well configured, please do not change any setting on Smart Meter.
2. One Smart Meter can only be used for one BH inverter.
3. CT must be connected on the same direction as the CT indicated.

Anti-Reverse Function Connection

If BH system (connected with grid-tied inverters) requires anti-reverse function, it is operable but please note:

1. This diagram is only for installation where has exporting power limit function requirement.
2. For anti-reverse function, will also need set on PV Master App→Advanced Setting→Power Limit.
3. This diagram only be reasonable if grid-tied inverter has anti-reverse function itself. And the power limitation value shall be set on grid-tied inverter.
4. When using anti-reverse function, it would buy about 100W from the grid.

Connection Diagram As Below:

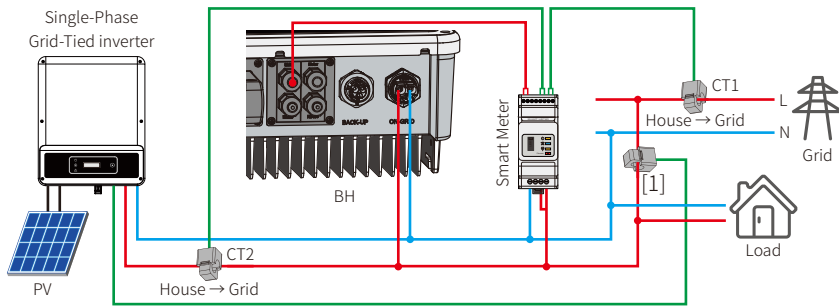

[1] This cable is a theoretical connection supporting anti-reverse function, which could be different for different grid-tied inverters.

2.5 DRED & Remote Shutdown Connection

DRED(demand response enabling device) is only for Australian and New Zealand installations, in compliance with Australian and New Zealand safety requirements. And DRED is not provided by manufacturer.

Remote shutdown is only for Europe installations, in compliance with Europe safety requirements. And Remote shutdown device is not provided by GoodWe.

Detailed operation is shown as below:

Step 1

Screw this plate off from inverter.

Note: DRED device should be connected through "DRED port" as the figure shows.

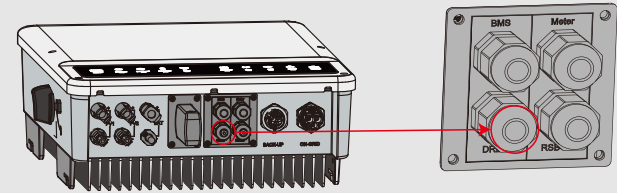

Step 2

1. Plug out the 6-pin terminal and dismantle the resistor on it.
2. Plug the resistor out, leave the 6-pin terminal for next step.

Note: The 6-pin terminal in the inverter has the same function of DRED device. Please leave it in the inverter if no external device connected.

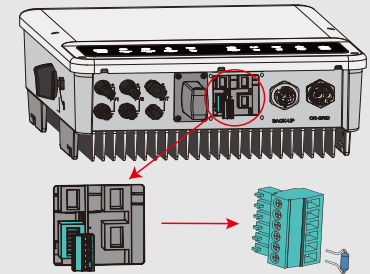

Step 3-1 For DRED

1. Put DRED cable through the plate.
2. Connect DRED cable on the 6-pin terminal.

The function of each connection position

NO	1	2	3	4	5	6
Function	DRM1/5	DRM2/6	DRM3/7	DRM4/8	REFGEN	COM / DRMO

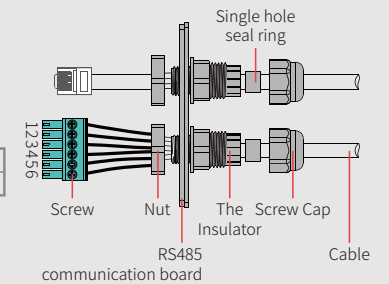

Step 3-2 For Remote Shutdown

1. Put the cable through the plate.
2. Wiring from the No. 5 and 6 holes respectively.

The function of each connection position

NO	5	6
Function	REFGEN	COM / DRMO

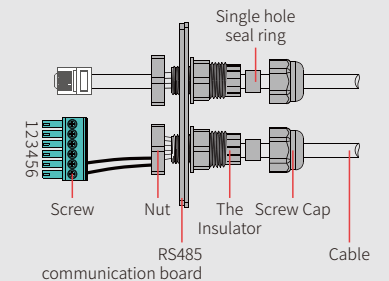

Step 4

Connect the terminal to the right position onto the inverter.

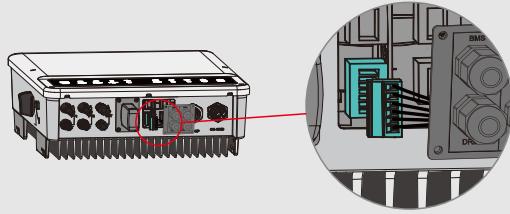

2.6 Earth Fault Alarm Connection

BH series inverter complies with IEC 62109-2 13.9. Fault indicator LED on inverter cover will light up and the system will email the fault information to customer.

Inverter should be installed at eye level for convenient maintenance.

2.7 SEMS Portal

SEMS Portal is an online monitoring system. After completing the installation of communication connection, you can access www.semsportal.com or download the App by scanning the QR code to monitor your PV plant and device.

Please contact the after-sales for more operation of SEMS Portal.



SEMS Portal App

WIRING SYSTEM FOR BH SERIES HYBRID INVERTER

Please select Breaker according to the specification below

	①	②	③	④	⑤
GW3K-BH	40A/600V DC breaker	50A/230V AC breaker	32A/230V AC breaker	Depends on household loads	
GW3600-BH		50A/230V AC breaker	32A/230V AC breaker		
GW5000-BH		63A/230V AC breaker	32A/230V AC breaker		
GW6000-BH		63A/230V AC breaker	40A/230V AC breaker		

[1] For batteries with attached switch, the external DC switch is not necessary.

[2] Only for lithium battery which has BMS communication.

[3] Direction of the CT cannot be connected in reverse, please follow "House → Grid" direction to do the connection.

For Spain Grid code, the output max. apparent power of GW6000-BH is 6KVA and will be less than 5kVA exported to grid limited by CT controller and power meter.

If the generation facility to be connected to the supply network with more than 5 kVA power in single phase, connection of the facility to the network shall be three-phase with an imbalance between phases of less than 5kW.

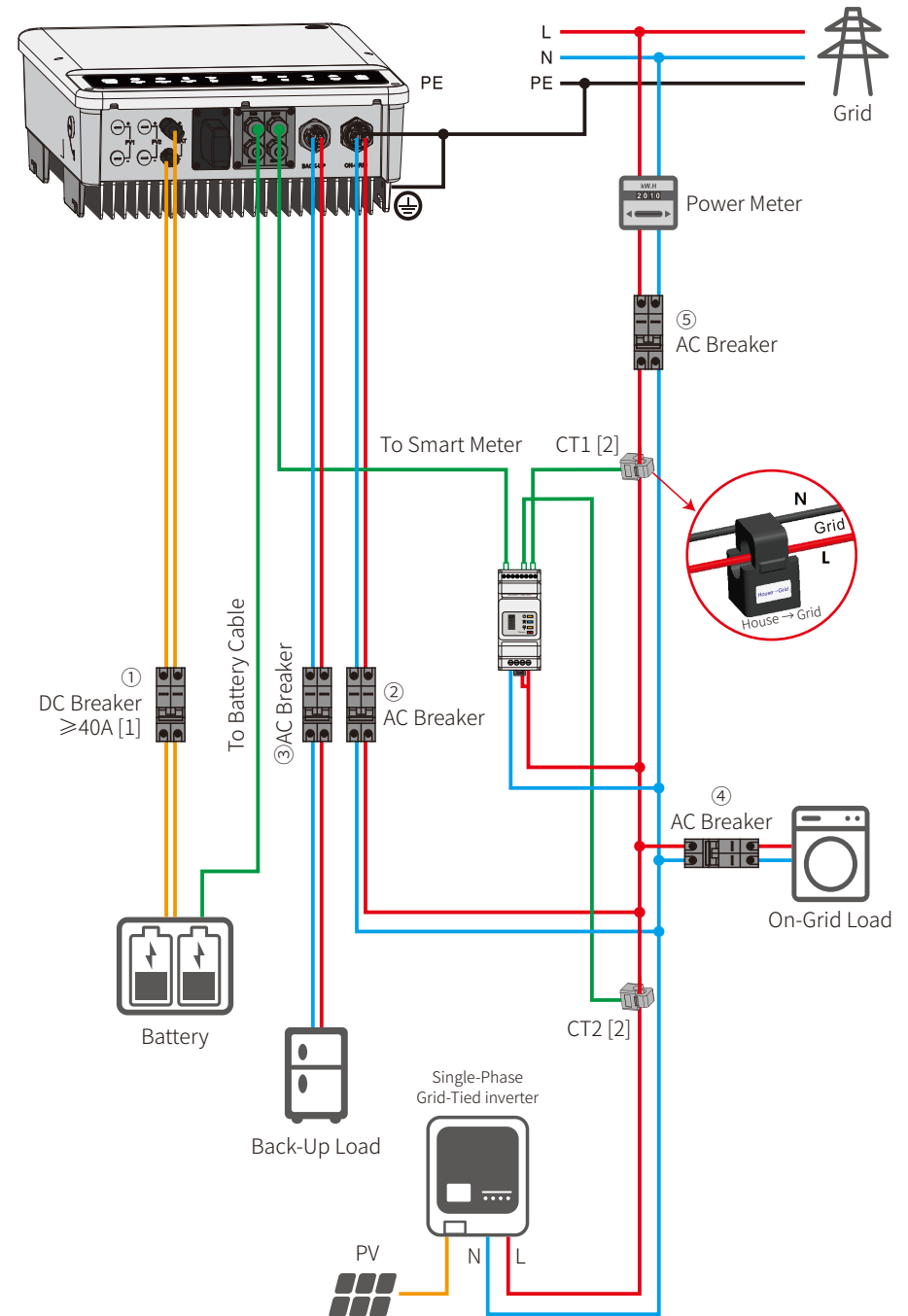

System Connection Diagrams

Note: According to Australian safety country, the neutral cable of on-grid side and back-up side must be connected together, otherwise back-up function will not work.

This diagram is an example for application that Neutral connects together with PE in distribution box. Such as: Australia, New Zealand, South Africa, etc. (Please follow local wiring regulations!)

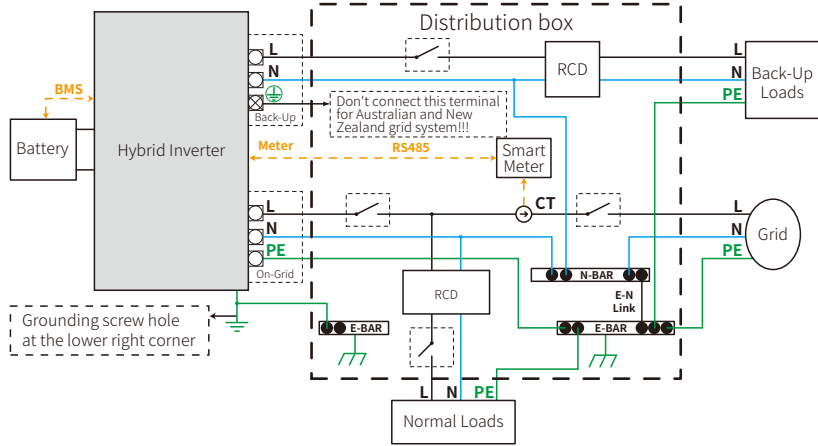

This diagram is an example for grid systems without special requirements on electrical wiring connection.

Note: The back-up PE line and earthing bar must be grounded properly and effectively. Otherwise the back-up function may be abnormal when the grid fails.

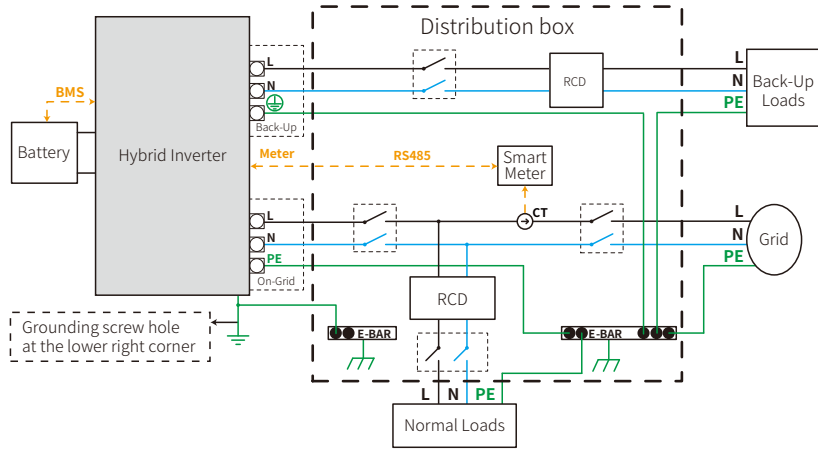

Note: After the inverter is installed and worked normal when the grid connected, please turn off the grid power to check whether the Back-Up function is normal, which can avoid the problems in subsequent uses.

03 MANUAL OPERATION

3.1 Wi-Fi Configuration

This part shows configuration on web page. You can also complete the configuration with PV Master App. Wi-Fi configuration is absolutely necessary for online monitoring and maintenance.

Preparation:

1. Inverter must be powered up with battery or grid power.
2. Router with available internet access to the website www.semsportal.com is required.

Step 1

1. Connect Solar-WiFi* to your PC or smart phone (* its named the last 8 character of the inverter's serial No.).
2. Open browser and login 10.10.100.253 Admin (User): admin; Password: admin.
3. Then click "OK".

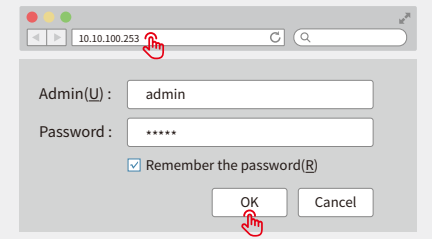

Step 2

1. Click "Start Setup" to choose your router.
2. Then click "Next".

Device information

Firmware version	1.6.9.3.38.2.1.38
MAC address	60:C5:A8:60:33:E1
Wireless AP mode	Enable
SSID	Solar-WiFi
IP address	10.10.100.253
Wireless STA mode	Disable
Router SSID	WiFi_Bum-in
Encryption method	WAP/WAP2-PSK
Encryption algorithm	AES
Router Password	WiFi_Bum-in

Cannot join the network, may be caused by:

No router / weak WiFi signal / password is not correct

★ Help: Wizard will help you to complete setting with one minute.

Start Setup

Please select your current wireless network

SSID	AUTH/ENCRY	RSSI	Channel
WiFi_Bum-in	WPAPSKWPA2PSK/TKIPAES	66	1
WiFi_Bum-in	WPAPSKWPA2PSK/TKIPAES	100	1
WiFi_Bum-in	WPAPSKWPA2PSK/TKIPAES	70	1
WiFi_Bum-in2	WPAPSKWPA2PSK/TKIPAES	72	1

Refresh

★ Help: When RSSI of the selected Wi-Fi network is lower than 15%, the connection may be unstable. Please select other available network or shorten the distance between the device and router. If you wireless router does not broadcast SSID, please click "Next" and add a wireless network manually.

Back Next

Step 3

1. Fill in the password of the router, then click "Next".
2. Click "Complete".

Add wireless network manually

Network name (SSID)	WiFi-Test
Encryption method	WPA/WPA2-PSK
Encryption algorithm	AES

Please enter the wireless network password:

Password (8-63 bytes)	Router password
	show psk

Note: Case sensitive for SSID and password, Please make sure all parameters of wireless network are matched with router, including password.

Back Next

Note:

If the Wi-Fi module fail to connect to network after enter the right passwords. It's possible that there is special characters not supported by module in the hotspot passwords.

Save success!

Click "Complete", the current configuration will take effect after restart.

If you still need to configure the other pages of information, please go to complete your required configuration.

Configuration is completed, you can log on the Management page to restart device by Click on "OK" button.

Confirm to complete?

Back Complete

Note:

1. Please make sure the password, Encryption method / algorithm is the same as the router's.
2. If everything is right well, the Wi-Fi LED on inverter will change from double blink to quartic blink then to solid status, which means Wi-Fi has connected to the server successfully.
3. Wi-Fi configuration could also be done on PV Master App, details please check on PV Master App.

Wi-Fi Communication

Wi-Fi Reset means restarting Wi-Fi module, Wi-Fi setting will be reprocessed and saved automatically. Wi-Fi Reload means setting Wi-Fi module back to default factory setting.

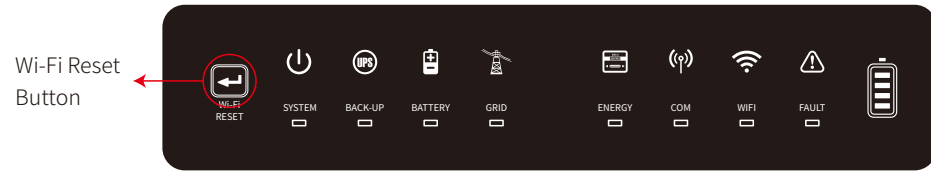

Wi-Fi Reset

Short press reset the button.
Wi-Fi LED will blink for a few seconds.

Note:

Wi-Fi reset & reload function is only used when:

1. Wi-Fi loses connection to internet or cannot connect to PV Master App successfully.
2. Cannot find "Solar-WiFi signal" or have other Wi-Fi configuration problems.
3. Please do not use this button if Wi-Fi monitoring works well.

Wi-Fi Reload

Long press reset the button (over 3s).
Wi-Fi LED will double blink until Wi-Fi configuration again.

3.2 PV Master App

PV Master is an external monitoring / configuration application for hybrid inverters, used on smart phones or tablet for both Android and iOS system. Main functions are as below:

1. Edit system configuration to make the system work as customer needs.
2. Monitor and check the performance of the hybrid system.
3. Wi-Fi configuration.

Please download PV Master App from Google Play Store or Apple App Store. You can also download the App by scanning the QR code on the back of this user manual.

Please download "PV Master Operation Instructions" from www.goodwe.com

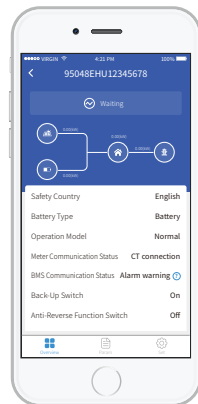

3.3 CEI Auto-Test Function

PV auto-test function of CEI is integrated in PV Master App for Italy's safety country requirements. For detailed instruction of this function please refer to "PV Master Operation Instructions".

3.4 Safety Parameter Settings

Set the QU curve, PU curve, and PF power curve in PV Master. Please contact the service center if you need to set them. (For Australia and New Zealand only)
Steps to set the curves: "Settings→Advanced Setting→Custom safety parameters→Curve setting"

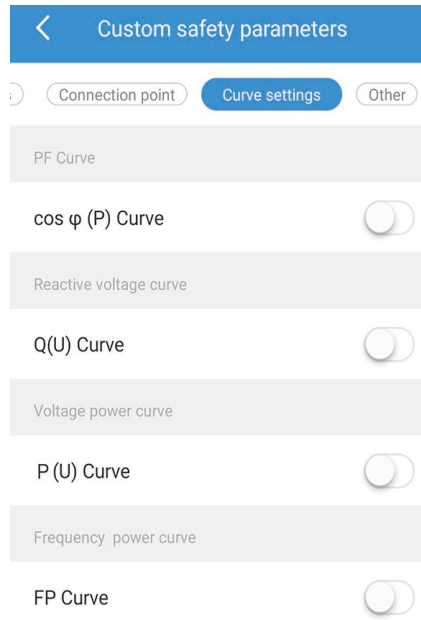

PF Power Curve Mode

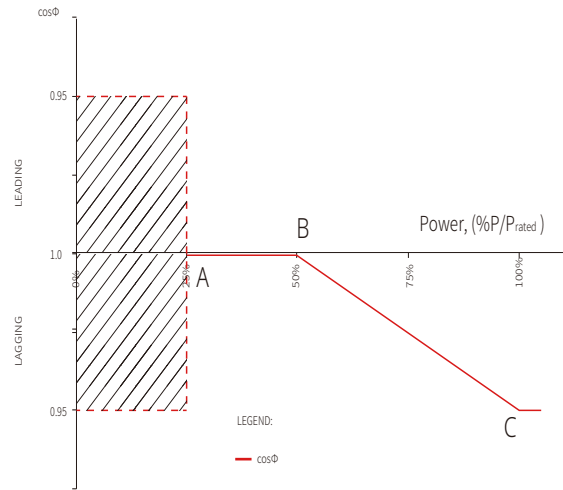

PF Power Curve Mode			
Function	Default value (Australia)	Default value (New Zealand)	Setting range
B %P/Prated	50%	50%	30%~80%
C Power factor	0.9	0.9	0.8-1

Power Recovery Slope

Power Recovery Slope		
Function	The default value (Australia & New Zealand)	Setting range
Rising slope	16.67%Pn/min	5-100%Pn/min
Falling slope	16.67%Pn/min	5-100%Pn/min

PU curve Mode

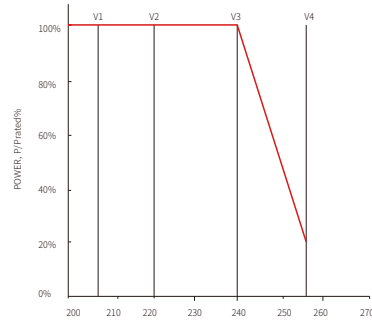
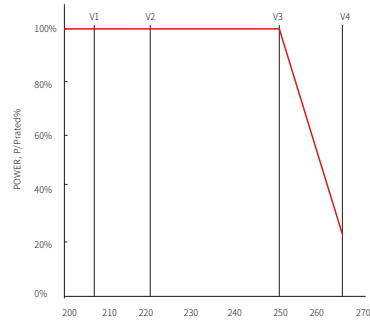

PU curve Mode (Discharge)			
Function	Default value (Australia)	Default value (New Zealand)	Setting range
V1 voltage ratio	207V	207V	Not applicable
P1 power ratio	100%*Pn	100%*Pn	0-100%*Pn
V2 voltage ratio	220V	220V	216 to 230
P2 power ratio	100%*Pn	100%*Pn	0-100%*Pn
V3 voltage ratio	250V	244V	235 to 255
P3 power ratio	100%*Pn	100%*Pn	0-100%*Pn
V4 voltage ratio	265V	255V	244 to 265
P4 power ratio	20%*Pn	20%*Pn	0-20%*Pn

PU curve Mode (Charge)			
Function	Default value (Australia)	Default value (New Zealand)	Setting range
V1 voltage ratio	207V	207V	Not applicable
P1 power ratio	0%*Pn	0%*Pn	Not applicable
V2 voltage ratio	220V	220V	216 to 230V
P2 power ratio	100%*Pn	100%*Pn	0-100%*Pn
V3 voltage ratio	250V	244V	235 to 255
P3 power ratio	100%*Pn	100%*Pn	0-100%*Pn
V4 voltage ratio	265V	255V	244 to 265
P4 power ratio	100%*Pn	100%*Pn	0-100%*Pn

QU curve Mode

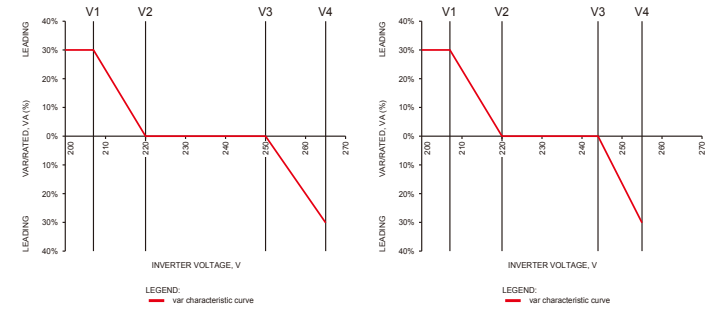

QU curve Mode			
Function	Default value (Australia)	Default value (New Zealand)	Setting range
V1 voltage ratio	207V	207V	Not applicable
Q1 reactive power ratio	30% leading	30% leading	0 to 60% leading
V2 voltage ratio	220V	220V	216 to 230
Q2 reactive power ratio	0%	0%	0%
V3 voltage ratio	250V	244V	235 to 255
Q3 reactive power ratio	0%	0%	0%
V4 voltage ratio	265V	255V	244 to 265
Q4 reactive power ratio	30% lagging	30% lagging	0 to 60% lagging

3.5 Startup/shutdown Procedure

3.5.1 Startup Procedure

Note: Before closing the AC breaker between the inverter and the grid, you need to use a multimeter to measure whether the AC voltage is within the allowable range.

step 1 Turn on the breaker between the inverter and the battery.

step 2 Turn on the AC breaker between the inverter and the grid.

step 2 Please wait for about 1 minute, observe the LED indicator of the inverter, and check the running status of the inverter

3.5.2 shutdown Procedure

Note: After the inverter system is shut down, the machine still has residual electricity and heat, which may cause electric shock or burns. So after the inverter system is powered off for 5 minutes, wear protective gloves before operating the inverter.

step 1 Turn off the AC breaker between the inverter and the grid.

step 2 Turn off the DC breaker between the inverter and the battery.

04 OTHERS

4.1 Troubleshootings

Checking Before Turn On AC Power

- **Battery Connection:** Confirm the connection between BH and battery : polarities (+/-) not reversed, refer to Pic 33.
- **On-Grid & Back-Up Connection:** Confirm ON-GRID connected to power grid and Back-Up to loads: polarity (+/-) not reversed, refer to Pic 34.
- **Smart Meter & CT Connection:** Make sure Smart Meter & CT are connected between house loads and grid, follow the Smart Meter direction sign on CT, refer to Pic 35.

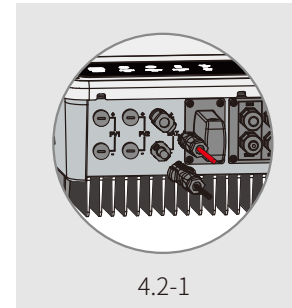

4.2-1

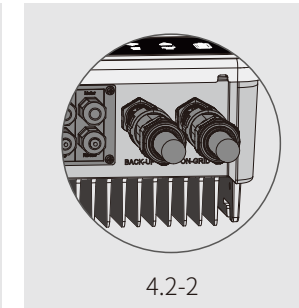

4.2-2

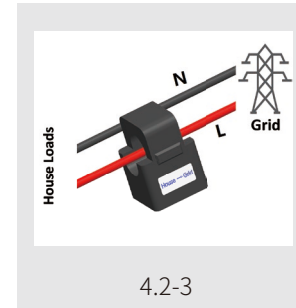

4.2-3

Checking As Start BH Up And Turn On AC Power

Battery Settings, BMS Communication And Safety Country:

After connecting Solar-WiFi* (*The Wi-Fi signal is named the last 8 characters of the inverter's serial No.), check on PV Master App "Param" to make sure battery type is the same as what you have installed, and "Safety Country" Setting is right. Please set it right in "Set" if the setting is not right.

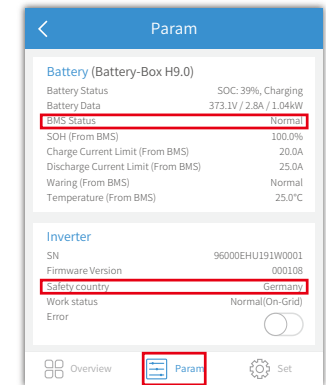
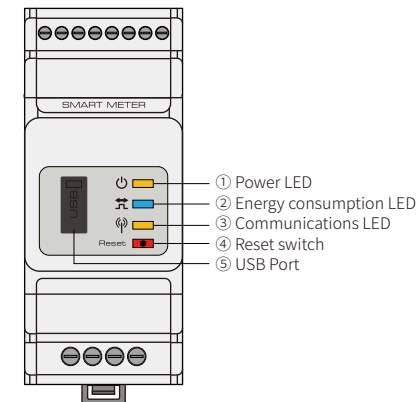

Note: For compatible lithium batteries, BMS status will display "Normal" after selecting the right battery company.

Possible Problems During Operation

High Power Fluctuation on Battery Charge or Discharge:

Solution:

Check if there is a fluctuation on load power.

Battery Does Not Charge:

Solution:

1. Make sure BMS communication is OK on PV Master.
2. Check if CT connected in the right position and to right direction as on the user manual page 15.

Questions & Answer (Q&A)

About Wi-Fi Configuration

Q: Why can't I find the Solar-WiFi* signal on mobile devices?

A: Normally Solar-WiFi* signal could be searched right after inverter has powered up. But Solar-Wi-Fi signal will disappear when EM connects to internet. If changes to the setting are required, connect to the router for change. If you can't find the WiFi signal or connect to the router, then please try to reload Wi-Fi (please refer to "3.1 Wi-Fi Configuration").

Q: Why can't I connect Solar-WiFi* signal on my phone?

A: The Wifi module can only connect to one device at a time. If the signal is already connected to another device at the time for some reason, you cannot connect to the signal.

Q: Why does the Wi-Fi module fail to connect to network after I choose the right router hotspot and enter the right passwords?

A: It's possible that there are special characters not supported by module in the hotspot passwords. Please modify the password to consist of only Arabic numerals or uppercase /lowercase letters.

About Battery Operation

Q: Why does the battery not discharge when grid is not available, while it discharges normally when grid is available?

A: On the App, off-grid output and back-up function should be turned on to make battery discharge under off-grid mode.

Q: Why is there no output on back-up side?

A: For back-up supply, the "Back-Up Supply" on PV Master App must be turned on. Under off-grid mode or when grid power is disconnected, "Off-Grid Output Switch" function must be turned on as well.

Note: When turning "Off-Grid Output Switch" on, don't restart inverter or battery, otherwise the function will be switched off automatically.

Q: On Portal, why battery SOC has a sudden jump up to 95%?

A: This normally happens on when BMS communication fail on lithium. If battery enter float charge, SOC will be reset to 95% compulsively.

Q: Why battery cannot be fully charged to 100%?

A: Battery will stop charge when battery voltage reaches charge voltage set on PV Master APP.

Q: Why battery breaker always trip when starts it up (Lithium battery)?

A: The breaker of lithium battery normally trips for following reasons:

1. BMS communication fails.
2. Battery SOC is too low, battery trips to protect itself.
3. An electrical short-cut happened on battery connection side. Or other reasons please contact After-sales for details.

Q: Which battery should I use for BH?

A: For BH series inverter, it could connect lithium batteries which have compatibility with BH series inverter with nominal voltage from 85V to 450V. Compatible lithium batteries can see on battery list in PV Master APP.

About PV Master Operation and Monitoring

Q: Why can't I save settings on PV Master App?

A: It could be caused by losing connection to Solar-WiFi*.

1. Make sure you have already connected Solar-WiFi* (make sure no other devices connected) or router (if connected Solar-WiFi* to router). APP's homepage shows connection well.
2. Make sure you restart inverter 10mins after you change some settings because inverter will save settings every 10 mins under normal mode. We recommend to change setting parameters when inverter is in wait mode.

Q: Why are the data displayed on the homepage different from the param page, like charge/discharge, PV value, load value or grid value?

A: The data refresh frequency is different, so there will be a data inconformity between different pages on the App as well as between these on portal and App.

Q: Some columns show NA, like battery SOH, etc. Why does that happen?

A: NA means App does not receive data from inverter or server because of communication problem, such as battery communication, and communication between inverter and the App.

About Smart Meter And Power Limit Function

Q: How to activate output power limit function?

A: For BH system, the function could be realized by:

1. Make sure Smart Meter connection and communication well.
2. Turn on export power limit function and set the max output power to grid on App.

Note: Even if output power limit is set to 0W, there might still be a deviation of a max of 100W exporting to grid.

Q: Why is there still power exporting to grid after I set power limit as 0W?

A: Export limit could be 0W theoretically, but there will be a deviation of around 50-100W for BH system.

Q: Can I use other brand Meter to take over Smart Meter in BH system or change some settings on Smart Meter?

A: No, because the communication protocol is integrated into inverter and Smart Meter, other brand meters cannot communicate. Also any manual setting change could cause Meter communication failure.

Q: What is the maximum current allowed to go through CT on Smart Meter?

A: The max current for CT is 120A.

Other Questions

Q: Is there a quick way to make the system work?

A: For the shortest way, please refer to "BH Quick Installation Instructions" and "PV Master App Instruction".

Q: What kind of load can I use to connect on Back-Up side?

A: Please refer to "2.4.2 On-Grid & Back-Up Connection: Declaration For Back-Up Overload Protection".

Q: Will the warranty of the inverter still be valid if for some special conditions we cannot 100% follow the user manual instructions on the installation or operation?

A: Normally we still provide technical support to problems caused from disobeying the instructions on the user manual, however we cannot guarantee any replacements or returns. So if there is any special conditions where you cannot 100% follow the instructions, please contact after-sales for suggestions.

4.2 Disclaimer

The BH series inverters are transported, used and operated under environmental and electrical conditions. Manufacturer has the right not to provide after-sales services or assistance under following conditions:

- Inverter is damaged during transfer.
- Inverter is out of warranty year and extended warranty is not bought.
- Inverter is installed, refitted or operated in improper ways without authority from manufacturer.
- Inverter is installed or used under improper environment or technical condition mentioned in this user manual, without authority from manufacturer.
- Installation or configuration of the inverter does not follow requirements mentioned in this user manual.
- The inverter is installed or operated against the requirements or warnings that are mentioned in this user manual.
- Inverter is broken or damaged by any force majeure like lightening, earthquake, fire hazard, storm and volcanic eruption etc.
- Inverter is disassembled, changed or updated on software or hardware without authority from manufacturer.
- Inverter is installed, used or operated against any related items in international or local policies or regulations.
- Any non-compatible batteries, loads or other devices connected to BH system.

Note:

Manufacturer will keep the right to explain all the contents in this user manual. To insure IP65, inverter must be sealed well, please install the inverters within one day after unpacking, otherwise please seal all unused terminals / holes, unused terminals / holes are not allowed to be kept open, confirm that there is no risk of water or dust entering the terminals / holes.

Maintenance

The inverter requires periodical maintenance, details are shown below:

- Make sure inverter is totally isolated from all DC and AC power for at least 5 mins before maintenance.
- Heat sink: Please use clean towel to clean up heat sink once a year.
- Torque: Please use torque wrench to tighten AC and DC wiring connection once a year.
- DC breaker: Check DC breaker regularly, active the DC breaker 10 times in a row once a year.
- Operating DC breaker will clean contacts and extend lifespan of DC breaker.
- Water-proof plate: Check if water-proof plate of RS485 and other part are replaced once a year.

4.2 Error Message

The error messages below will be displayed on PV Master App or report by Email if the error really happen.

ERROR MESSAGE	EXPLANATION	REASON	SOLUTIONS
Utility Loss	Not available of public grid power (power lost or on-grid connection fails)	Inverter does not detect the connection of grid	<ol style="list-style-type: none"> 1. Check (use multi-meter) if AC side has voltage . Make sure grid power is available. 2. Make sure AC cables are connected tightly and right well. 3. If all is well, please try to turn off AC breaker and turn on again after 5 mins.
VAC Failure	Grid voltage is not within permissible range	Inverter detects that AC voltage is beyond the normal range required by the safety country	<ol style="list-style-type: none"> 1. Make sure safety country of the inverter is set right. 2. Check (use multi-meter) if AC voltage (Between L & N) is within a normal range (Also on AC breaker side) <ol style="list-style-type: none"> a. if AC voltage is high, then make sure AC cable complies with that required on user manual and AC cable is not too long. b. if voltage is low, make sure AC cable is connected well and the jacket of AC cable is not compressed into AC terminal. 3. Make sure the grid voltage of your area is stable and within normal range.
FAC Failure	Grid Efficiency is not within permissible range	Inverter detects that Grid frequency is beyond the normal range required by the safety country	<ol style="list-style-type: none"> 1. Make sure safety country of the inverter is set right. 2. If safety country is right, then please check on inverter display if AC frequency (Fac) is within a normal range. 3. If FAC failure only appear a few times and resolved soon, it should be caused by occasional grid frequency instability.
Relay Check Failure	Self checking of relay fails	Neutral & ground cable are not connected well on AC side or just occasional failure	Check use multi-meter if there is high voltage (normally should be lower than 10V) between N&PE cable on AC side. If the voltage higher than 10V, it means the Neutral & ground cable are not connected well on AC side or restart inverter.
Over Temperature	Temperature inside of the inverter is too high	Inverter working environment leads to a high temperature condition	<ol style="list-style-type: none"> 1. Try to decrease surrounding temperature. 2. Make sure the installation complies with the instruction on inverter user manual. 3. Try to close inverter for 15 mins, then start up again.
DC Injection High	/	Inverter detects a higher DC component in AC output	Try to restart inverter, check if it still happens, if not, means it is just an occasional situation or contact GoodWe.
EEPROM R/W Failure	/	Caused by a strong external magnetic field etc.	Try to restart inverter, check if it still happens, if not, means it is just an occasional situation or contact GoodWe.
SPI Failure	Internal communication fails	Caused by a strong external magnetic field etc.	Try to restart inverter, check if it still happens, if not, means it is just an occasional situation or contact GoodWe.
DC Bus High	BUS voltage is over-high	/	Try to restart inverter, check if it still happens, if not, means it is just an occasional situation or contact GoodWe.
Back-Up OverLoad	Back-up side is over loaded	Total Back-Up load power is higher than the nominal backup output power	Decrease Back-Up loads to make sure the total load power is lower than Back-Up nominal output power (please refer to page 12).

NOTE: All the errors about battery happen only on Lithium battery with BMS communication.

4.4 TECHNICAL PARAMETERS AND CERTIFICATES

TECHNICAL PARAMETERS OF BH INVERTER

Technical Data	GW3K-BH	GW3600-BH	GW5000-BH	GW6000-BH
Battery Input Data				
Battery Type	Li-Ion	Li-Ion	Li-Ion	Li-Ion
Battery Voltage Range(V)	85~400	85~450	85~450	85~450
Start-up Voltage (V)	90	90	90	90
Max. Charging/Discharging Current (A)	25/25	25/25	25/25	25/25
AC Output/Input Data (On-grid)				
Nominal Apparent Power Output to Utility Grid (VA)	3000	3600	4600/5000[2]	4600/5000/6000[1]
Max. Apparent Power Output to Utility Grid(VA)	3000/3360[6]	3600/3960[5]	4600/5000/5500[4]	4600/5000/6000/6600[3]
Max. Apparent Power from Utility Grid (VA)	6000 (Charging 3kW, backup output 3kW)	7200 (Charging 3.6kW, backup output 3.6kW)	10000 (Charging 5kW, backup output 5kW)	12000 (Charging 6kW, backup output 6kW)
Nominal Output Voltage (V)	230	230	230	230
Nominal Output Frequency (Hz)	50/60	50/60	50/60	50/60
Max. AC Current Output to Utility Grid (A)	13.1/14.3[11]	16.0/18.0[10]	21.7[7]/24.0[9]	21.7[7]/26.1/28.7[8]
Max. AC Current From Utility Grid (A)	52.2	32	43.4	52.2
Output Power Factor	Adjustable from 0.8 leading to 0.8 lagging			
Output THDi (@Nominal Output)	<3%	<3%	<3%	<3%
Back-Up Output Data				
Max. Output Apparent Power (VA)	3000	3600	5000	6000
Peak Output Apparent Power (VA)	3600, 60sec	4320, 60sec	6000, 60sec	7200, 60sec
Max. Output Current (A)	13.1	15.7	21.7	26.1
Automatic Switch Time (ms)	<10			
Nominal Output Voltage (V)	230 (±2%)			
Nominal Output Frequency (Hz)	50/60 (±0.2%)			
Output THDv (@Linear Load)	<3%			
Efficiency				
Max. Efficiency	96.6%			
Protection				
Anti-islanding Protection	Integrated			
Battery Input Reverse Polarity Protection	Integrated			
Insulation Resistor Detection	Integrated			
Residual Current Monitoring Unit	Integrated			
Output Over Current Protection	Integrated			
Grid Output Short Protection	Integrated			
Output Over Voltage Protection	Integrated			
General Data				
Operating Temperature Range (°C)	-35~60			
Relative Humidity	0~95%			
Environment Category	Outdoor & indoor			
External Environment Pollution Degree	Grade1、2、3			
Protective class	Class I			

Technical Data	GW3K-BH	GW3600-BH	GW5000-BH	GW6000-BH
General Data				
Over voltage category	DC II: ACIII			
Operating Altitude (m)	4000			
Cooling	Nature Convection			
Noise (dB)	<35			
User Interface	LED & APP			
Communication with BMS	CAN			
Communication with Meter	RS485			
Communication with Portal	Wi-Fi/Ethernet (Optional)			
Weight (kg)	15.5			
Size (Width*Height*Depth mm)	354*433*147			
Mounting	Wall Bracket			
Protection Degree	IP65			
Standby Self Consumption (W) [12]	<10			
Topology	Transformerless			
Certifications & Standards				
Grid Regulation	AS/NZS 4777.2:2015; G99; CEI 0-21 VDE4105-AR-N	AS/NZS 4777.2:2015; G99; CEI 0-21 VDE4105-AR-N	AS/NZS 4777.2:2015; G99; CEI 0-21 VDE4105-AR-N	AS/NZS 4777.2:2015; G98; CEI 0-21
Safety Regulation	IEC/EN 62477-1 AS 62040.1.1	IEC/EN 62477-1 AS 62040.1.1	IEC/EN 62477-1 AS 62040.1.1	IEC/EN 62477-1 AS 62040.1.1
EMC	EN61000-6-1 EN61000-6-2 EN61000-6-3 EN61000-6-4	EN61000-6-1 EN61000-6-2 EN61000-6-3 EN61000-6-4	EN61000-6-1 EN61000-6-2 EN61000-6-3 EN61000-6-4	EN61000-6-1 EN61000-6-2 EN61000-6-3 EN61000-6-4 EN61000-4-16 EN61000-4-18 EN61000-4-29

[1] 4600 for VDE-AR-N 4105, 4950 for AS/NZS 4777.2, 5000 for Spain feed in power limit, selfuse can reach 6000, 6000 for other country.

[2] 4600 for VDE-AR-N 4105, 4950 for AS/NZS 4777.2, 5000 for other country.

[3] 4600 for VDE-AR-N 4105, 4950 for AS/NZS 4777.2, , 5000 for Spain, 6600 for CEI 0-21, 6000 for other country.

[4] 4600 for VDE-AR-N 4105, 4950 for AS/NZS 4777.2, 5500 for CEI 0-21, 5000 for other country.

[5] 3960 for CEI 0-21, 3600 for other countries.

[6] 3300 for CEI 0-21, 3000 for other countries.

[7] 21.7 for AS/NZS 4777.2 feed in power limit, selfuse can reach 26.1.

[8][9][10][11] for CEI 0-21.

[12] No Back-up Output

4.5 Other Test

For Australian requirements, in the THDi test, Zref should be added between inverter and mains.

RA, XA for Line conductor

RN, XN for Neutral conductor

Zref:

RA=0, 24; XA=j0,15 at 50Hz;

RN=0, 16; XN=j0,10 at 50Hz

4.6 Quick Check List To Avoid Danger

1. Inverter cannot be installed near flammable, explosive or strong electro-magnetic equipment, please refer to "2.3.1 Select Mounting Location".
2. Remember that this inverter is heavy! Please be careful when lifting out from the package, please refer to "2.3.2 Mounting".
3. Make sure battery breaker is off and battery nominal voltage meets EM specification before connecting battery to inverter and make sure inverter is totally isolated from PV and AC power, please refer to "2.4 Electrical Wiring Connection".
4. Make sure inverter is totally isolated from any DC or AC power before connecting AC cable, please refer to "2.4.2 On-Grid & Back-Up Connection".
5. Make sure AC cable is totally isolated from AC power before connecting Smart Meter & CT, please refer to "2.4.3 Smart Meter & CT Connection".

Appendix Protection Category Defintion

Overvoltage Category Definition

Category I	Applies to equipment connected to a circuit where measures have been taken to reduce transient overvoltage to a low level.
Category II	Applies to equipment not permanently connected to the installation. Examples are appliances, portables tools and other plug-connected equipment.
Category III	Applies to a fixed equipment downstream and including the main distribution board. Examples are switchgear and other equipment in an industrial installation.
Category IV	Applies to equipment permanently connected at the origin of an installation (uostream of the main distribution board). Examples are electricity meters, primary over-current protection equipment and other equipment connected directly to outdoor open lines.

Moisture Location Category Definition

Moisture Parameters	Level		
	3K3	4K3	4K4H
Temperature Range	0~+40°C	-33~+40°C	~20~+55°C
Moisture Parameters	5%~85%	15%~100%	4%~100%

Environment Category Definition

Environment Condition	Ambient Temperature	Relative Humidity	Applied to
Outdoor	-20~50°C	4%~100%	PD3
Indoor Unconditioned	-20~50°C	5%~95%	PD3
Indoor conditioned	0~40°C	5%~85%	PD2

Pollution Degree Definition

Pollution Degree I	No pollution or only dry, non-conductive pollution occurs. The pollution has no influence.
Pollution Degree II	Normally only non-conductive pollution occurs. Occasionally, however, a temporary conductivity caused by condensation must be expected.
Pollution Degree III	Conductive pollution occurs, or dry, non-conductive pollution occurs, which becomes conductive due to condensation, which is expected.
Pollution Degree IV	Persistent conductive pollution occurs, for example, the pollution caused by conductive dust, rain and snow.